



## CATALOGO GENERALE



2009

ACCESSORI PER SERRAMENTI

ACCESSORIES FOR WINDOW  
AND DOOR FRAMES

ACCESORIOS PARA HERRAJES



# L'entità e la forza dei valori

THE ENTITY AND THE STRENGTH OF OUR VALUES  
LA ENTIDAD Y LA FUERZA DE LOS VALORES

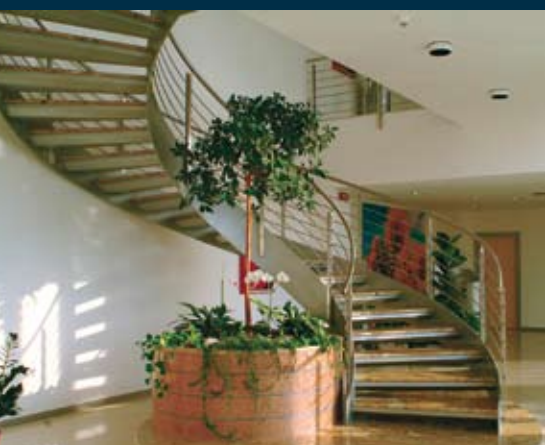



Il mercato attuale richiede maggiore professionalità, ricerca e competitività. La Esin Plast, azienda certificata ISO 9001/2000 e ISO 14001/2004, con la sua pluriennale esperienza nella progettazione e stampaggio di accessori in materiale termoplastico per la serramentistica, ha saputo collocarsi nella nicchia di aziende di "marca" puntando sulla forza dei valori. Esperienza, competenza e dinamismo in simbiosi per ottimizzare il processo produttivo.

Qualità del prodotto, servizio e professionalità, altri valori da offrire alla propria clientela.

Today's market requires more professionalism, research and competitiveness. Esinplast, a ISO 9001/2000 e ISO 14001/2004 certified company, with experience gained over the years in designing and moulding of accessories for doors, windows and shutters, has been able to place itself within a niche of quality companies thanks to its values. Experience, competence and energy together in order to enhance the production process.

We also offer our clientes product quality, service and professionalism.

El mercado actual exige cada vez más profesionalidad, investigación y competitividad. Esinplast empresa certificada ISO 9001/2000 e ISO 14001/2004 con su vasta experiencia a través de los años proyectando y moldeando accesorios para herrajes en material termoplástico se ha ganado un lugar de preferencia entre las empresas especializadas. El secreto de su éxito se basa en la fuerza de los valores: experiencia, competencia y dinamismo en simbiosis para optimizar el proceso productivo.

Calidad del producto, servicio y profesionalidad, otros valores ofrecidos a nuestra clientela.



ISO

---

CERTIFICAZIONI  
CERTIFICATIONS  
CERTIFICACIONES



# DET NORSKE VERITAS

## QUALITY MANAGEMENT SYSTEM CERTIFICATE

Certificato No. / Certificate No. **CERT-12554-2003-AQ-BOL-SINCERT**

Si attesta che / This certifies that

IL SISTEMA DI GESTIONE PER LA QUALITÀ DI / THE QUALITY MANAGEMENT SYSTEM OF

**ESINPLAST S.r.l.**

**Via S. Ubaldo, 31/d - 60030 Monsano (AN) - Italy**

È CONFORME AI REQUISITI DELLA NORMA PER I SISTEMI DI GESTIONE PER LA QUALITÀ  
CONFORMS TO THE QUALITY MANAGEMENT SYSTEMS STANDARD

**UNI EN ISO 9001:2000 (ISO 9001:2000)**

Questa certificazione è valida per il seguente campo applicativo:

This certificate is valid for the following products or services:

(Ulteriori chiarimenti riguardanti lo scopo e l'applicabilità dei requisiti della normativa si possono ottenere consultando l'organizzazione certificata)  
(Further clarifications regarding the scope and the applicability of the requirements of the standard(s) may be obtained by consulting the certified organisation)

**Progettazione, stampaggio ed assemblaggio di articoli tecnici ed accessori per infissi in  
resine termoplastiche; progettazione e produzione dei relativi stampi**

*Design, moulding and assembly of technical articles and accessories made of thermoplastic resin  
for window and doorframes; design and manufacture of related moulds*

*Luogo e data  
Place and date*

**Agrate Brianza, (MI) 2006-06-15**

*Data Prima Emissione:  
First Issue Date:*

**2003-06-23**

*per l'Organismo di Certificazione  
for the Accredited Unit*

**Det Norske Veritas Italia S.r.l.**

**Lead Auditor: GIOVANNI MARIA BOSSICH**

**Settore EA: 14 - 17**

**SINCERT**  
CERTIFICAZIONE SISTEMI DI GESTIONE

ISO Registrazione N. 0224  
BSI Registrazione N. 0020  
AFNOR Registrazione N. 0200

Member of the Bureau Veritas Group  
Signatory of the AFNOR Mutual Recognition Agreement

**Vittore Marangon**  
Management Representative

*La validità del presente certificato è subordinata a sorveglianza periodica (ogni 6, 9 o 12 mesi) e al riesame completo del sistema con periodicità triennale  
The validity of this certificate is subject to periodical audits (every 6, 9 or 12 months) and the complete re-assessment of the system every three years  
Le aziende in possesso di un certificato valido sono presenti nelle banche dati sul sito [www.dnv.it](http://www.dnv.it) e sul sito [www.bureauveritas.com](http://www.bureauveritas.com). All the companies with a valid certificate are online at the following addresses: [www.dnv.it](http://www.dnv.it) and [www.bureauveritas.com](http://www.bureauveritas.com)*



**RINA**  
www.rina.org

CISQ is a member of



www.iqnet-certification.com

**CERTIFICATO N. EMS-2202/S**  
**CERTIFICATE No.**

SI CERTIFICA CHE IL SISTEMA DI GESTIONE AMBIENTALE DI  
IT IS HEREBY CERTIFIED THAT THE ENVIRONMENTAL MANAGEMENT SYSTEM OF

**ESINPLAST S.R.L.**

VIA SANT'UBALDO 31/C-D-E 60030 MONSANO (AN) ITALIA

NELLE SEGUENTI UNITÀ OPERATIVE / IN THE FOLLOWING OPERATIONAL UNITS

VIA SANT'UBALDO 31/C-D-E 60030 MONSANO (AN) ITALIA

È CONFORME ALLA NORMA  
IS IN COMPLIANCE WITH THE STANDARD

**ISO 14001:2004**

E AL DOCUMENTO SINCERT RT-09

PER I SEGUENTI CAMPI DI ATTIVITÀ / FOR THE FOLLOWING FIELD(S) OF ACTIVITIES

PROGETTAZIONE, STAMPAGGIO ED ASSEMBLAGGIO DI ARTICOLI TECNICI ED ACCESSORI PER INFISSI IN  
RESINE TERMOPLASTICHE - PROGETTAZIONE E PRODUZIONE DEI RELATIVI STAMPI

DESIGN, MOULDING AND ASSEMBLY OF TECHNICAL ARTICLES AND ACCESSORIES MADE OF THERMOPLASTIC  
RESIN FOR WINDOWS AND DOORFRAMES - DESIGN AND MANUFACTURE OF RELATED MOULDS

L'uso e la validità del presente certificato sono soggetti al rispetto del documento RINA: Regolamento per la Certificazione di Sistemi di Gestione Ambientale  
The use and the validity of this certificate are subject to compliance with the RINA document: Rules for the Certification of Environmental Management Systems  
La validità del presente certificato è subordinata a sorveglianza periodica annuale / semestrale ed al riesame completo del sistema di gestione con periodicità triennale  
The validity of this certificate is dependent on an annual / six monthly audit and on a complete review, every three years, of the management system

Prima emissione First Issue	31.01.2008
Emissione corrente Current Issue	20.02.2008
Data scadenza Expiry Date	31.01.2011

Dott. Ing. Domenico Andreis  
(Direttore della Divisione Certificazione e Servizi)

**RINA SpA**  
Via Corsica 12 - 16128 Genova Italy



SGQ N° 002A - SGA N° 002D  
PRD N° 002B - PRS N° 006C  
SCR N° 003F - SSI N° 001G

Membro degli Accordi di Mutuo  
Riconoscimento EA e IAF  
Signatory of EA and IAF Mutual  
Recognition Agreements

EA:14  
EA:18

Per informazioni sulla validità  
del certificato, visitare il sito  
www.rina.org

For information concerning  
validity of the certificate, you  
can visit the site  
www.rina.org

CISQ è la Federazione Italiana di  
Organismi di Certificazione dei  
sistemi di gestione aziendale

CISQ is the Italian  
Federation of management  
system Certification Bodies



www.cisq.com

Form F2B/SUS/01/11/07



THE INTERNATIONAL CERTIFICATION NETWORK

# CERTIFICATE

IQNet and its partner  
**CISQ/RINA**

hereby certify that the organization  
**ESINPLAST S.R.L.**

VIA SANT'UBALDO 31/C-D-E 60030 MONSANO (AN) ITALIA

in the following operative units

VIA SANT'UBALDO 31/C-D-E 60030 MONSANO (AN) ITALIA

for the following field of activities

DESIGN, MOULDING AND ASSEMBLY OF TECHNICAL ARTICLES AND ACCESSORIES MADE OF THERMOPLASTIC RESIN FOR WINDOWS AND DOORFRAMES - DESIGN AND MANUFACTURE OF RELATED MOULDS

has implemented and maintains a

## Environmental Management System

which fulfills the requirements of the following standard

**ISO 14001:2004**  
*Registration Number:*

**IT-60498**

First Issue : 2008-01-31

Current Issue : 2008-02-20



René Wasmer

President of IQNET



Gianrenzo Prati

President of CISQ

*IQNet partners\*:*

AENOR Spain AFAQ AFNOR France AIB-Vinçotte International Belgium ANCE Mexico APCER Portugal CISQ Italy CQC China  
CQM China CQS Czech Republic Cro Cert Croatia DQS Germany DS Denmark ELOT Greece FCAV Brazil  
FONDONORMA Venezuela HKQAA Hong Kong China ICONTEC Colombia IMNC Mexico Inspecta Certification Finland  
IRAM Argentina JQA Japan KFQ Korea MSZT Hungary Nemko AS Norway NSAI Ireland PCBC Poland QMI Canada  
Quality Austria Austria RR Russia SAI Global Australia SII Israel SIQ Slovenia SIRIM QAS International Malaysia  
SQS Switzerland SRAC Romania TEST St Petersburg Russia YUQS Serbia

IQNet is represented in the USA by: AFAQ AFNOR, AIB-Vinçotte International, CISQ, DQS, NSAI Inc., QMI and SAI Global

\*The list of IQNet partners is valid at the time of issue of this certificate. Updated information is available under [www.iqnet-certification.com](http://www.iqnet-certification.com)



# INDICE ANALITICO



CODICE	DESCRIZIONE	CAP	PAG
00637 <b>2890</b>	Sella reversibile persiana fissa lamella centro storico Firenze mm 65x9 ALL.CO camera mm 14x35	VI	93
01032 <b>2890</b>	Sella reversibile persiana fissa lamella centro storico Firenze mm 65x10 DEMAL camera mm 14x35	VI	92
09999 <b>0005</b>	CICALONE Socchiudi finestra a una anta	I	7
09999 <b>0006</b>	MINI GRILLO fermo imposta automatico terza anta	I	6
09999 <b>0007</b>	CALABRONE fermo imposta manuale con vite da mm. 70	I	6
09999 <b>0009</b>	FARFALLA fermo imposta manuale con vite da mm. 70	I	6
09999 <b>0010</b>	Distanziale aperto dx - sx mm 39 con bordino e spessore per ovalina mm 50x10	VI	95
09999 <b>0012</b>	Rullo passa cinghia UNIBLOCK con piastrino e viti	I	7
09999 <b>0013</b>	Fermapaletto guida asta 40-50	I	8
09999 <b>0014</b>	Coprigocciolatoio	II	21
09999 <b>0017</b>	Tappo terminale per profilo persiana NC 40	II	16
09999 <b>0018</b>	Tappi terminali dx - sx per profilo persiana METRA - R 3553	II	15
09999 <b>0019</b>	Distanziale chiuso dx - sx mm 45,5 per ovalina mm 50x10	VI	94
09999 <b>0020</b>	Tappo terminale per profilo persiana NC 40 maggiorato	II	16
09999 <b>0022</b>	Distanziale aperto dx - sx mm 40 per ovalina mm 50x10	VI	94
09999 <b>0023</b>	Tappo terminale per profili persiana R 40 / 900396 - ALL.CO / 1494	II	14
09999 <b>0024</b>	Tappo terminale per profilo persiana camera NACO EKIP 40 / 10211 maggiorato - NC 40 maggiorato	II	15
09999 <b>0025</b>	Distanziale aperto dx - sx mm 39 con spessore per ovalina mm 50x10	VI	94
09999 <b>0026</b>	Tappo terminale per profili persiana R 40 / 900399 - ALL.CO 5	II	14
09999 <b>0027</b>	Sella reversibile (1° tipo) persiana fissa alla genovese per ovalina mm 50x10 FB 12 - METRA - ALL.CO - ALCAN - ABITHAL etc.	VI	86
09999 <b>0028</b>	Rullo infila guarnizioni per giunto aperto universale	V	78
09999 <b>0029</b>	Sella reversibile persiana fissa alla genovese per ovalina mm 60x10 FB 12 - METRA - ALL.CO - ALCAN - ABITHAL	VI	90
09999 <b>0030</b>	Tappo terminale per profili persiana ALPHA 445 - ALL.CO 1488/1569	II	16
09999 <b>0032</b>	Blocca astina Ø 6 per persiana a sporgere	I	8
09999 <b>0033</b>	Tappo per ovalina 10 x 50	II	16
09999 <b>0040</b>	Maniglione trafilato piccolo in alluminio da mm 160 con borchia tonda	IV	71
09999 <b>0041</b>	Maniglione trafilato piccolo in alluminio da mm 270 con borchia tonda	IV	72
09999 <b>0042</b>	Distanziale aperto dx - sx mm 39 con spessore per ovalina mm 50x10	VI	94
09999 <b>0043</b>	Maniglione profilato grande in alluminio da mm 320 con borchia tonda	IV	72
09999 <b>0044</b>	Maniglione trafilato piccolo in alluminio da mm 160 con borchia ovale	IV	71
09999 <b>0045</b>	Maniglione trafilato piccolo in alluminio da mm 270 con borchia ovale	IV	71
09999 <b>0046</b>	Maniglione profilato grande in alluminio da mm 320 con borchia ovale	IV	72
09999 <b>0049</b>	Pomolo PEGASO in alluminio con borchia tonda	IV	70
09999 <b>0052</b>	Contropiastra	I	10
09999 <b>0054</b>	Tappo terminale per profili persiana alla genovese FB 12 - METRA - ALL.CO	II	14
09999 <b>0056</b>	Spatola piccola per sollevamento vetri	V	80
09999 <b>0057</b>	Spatola grande per sollevamento vetri	V	80
09999 <b>0058</b>	Sella reversibile persiana fissa per ovalina mm 50x10 R 40 - ALPHA 455	VI	88
09999 <b>0059</b>	Sella reversibile persiana fissa per ovalina mm 50x10 ALL.CO 1494 / 1549	VI	87
09999 <b>0060</b>	Taglierino per imballaggi e infila guarnizioni ferma vetro	V	80
09999 <b>0061</b>	Sella reversibile persiana fissa alla genovese per ovalina mm 50x10 FB 12 - METRA - ALL.CO - ALCAN - ABITHAL	VI	86
09999 <b>0063</b>	Tappo terminale per profili persiana alla genovese maggiorati FB 12 - METRA - ALL.CO - GLOBAL	II	15
09999 <b>0068</b>	Cilindro di battuta regolabile (eccentrico)	I	8
09999 <b>0069</b>	Sella reversibile persiana fissa ovalina mm 50x10 EKIP 40 - METRA - GR 9 - NC - ALL.CO SPRINT P 4 - EURO 40 - SYNTHESIS - SISTEMA 1 - ALU ■ K 494 - ALL.CO 1494/1549	VI	87
09999 <b>0072</b>	Sella reversibile persiana fissa per ovalina mm 50x10 DOMAL GELOSIA - DOMAL 40 - DOMAL STOPPER PG - ALL.CO 5/1556	VI	87
09999 <b>0078</b>	Distanziale aperto dx - sx mm 39 con bordino e spessore per ovalina mm 50x10	VI	94
09999 <b>0080</b>	Pomolo PEGASO in alluminio con borchia ovale	IV	70
09999 <b>0081</b>	Borchia ovale per cilindro ovale	IV	68
09999 <b>0082</b>	Borchia sottile per cilindro sagomato	IV	68
09999 <b>0094</b>	Borchia ovale per cilindro sagomato	IV	68

CODICE	DESCRIZIONE	CAP	PAG
099990095	Riscontro regolabile per astina Ø 6	III	55
099990096	Borchia sottile per cilindro ovale	IV	68
099990098	Boccola di riscontro per astina Ø 6	I	8
099990099	LIBELLULA fermo imposta manuale con vite da mm. 70	I	6
099990100	Angolo di giunzione per imbotte in alluminio	VI	107
099990102	Distanziale aperto dx - sx mm 49 con bordino e spessore per ovalina mm 65x10	VI	95
099990103	Distanziale aperto dx - sx mm 49 con bordino e spessore per ovalina mm 65x10	VI	95
099990104	Sella reversibile persiana fissa alla genovese per ovalina mm 65x10 FB 12 - METRA - ALL.CO - ALCAN - ABITHAL	VI	91
099990105	Rullo infila guarnizioni R 40 / 50 - GLOBAL - ALL.CO 5 a sormonto	V	76
099990106	Rullo infila guarnizioni per precamera R 40 / 50 rigida	V	76
099990107	Rullo infila guarnizioni EKIP 50	V	77
099990108	Rullo infila guarnizioni EKIP 40	V	77
099990109	Rullo infila guarnizioni DECORA - SISTEMA 1 - SISTEMA 2 WOOD (PROFILATI s.p.a. T.E.S.)	V	78
099990110	Rullo infila guarnizioni nuovo NC 40	V	77
099990111	Rullo infila guarnizioni per zanzariera	V	76
099990112	Rullo infila guarnizioni ALL.CO 5 complanare	V	76
099990113	Rullo infila guarnizioni ALPHA 255 / 445 - BLITZ	V	76
099990114	Rullo infila guarnizioni NC 45 SUPER THERMIC - NC 45 INTERNATIONAL	V	77
099990116	Rullo infila guarnizioni DOMAL STOPPER - SYNTHESIS	V	77
099990122	Giunto DOMAL STOPPER PG	VI	96
099990123	Tappo terminale per profili persiana EKIP 40 / 8146 - METRA	II	15
099990127	Clips ferma vetro serie ALPHA 445 - GLOBO	I	11
099990194	Tappi dx - sx per profilo persiana ALL.CO VZ 3466	II	22
099990195	Tappo ALL.CO VZ 1255	II	23
099990196	Sella reversibile persiana fissa alla genovese per lamella centro storico mm 65x10	VI	92
099990233	Giunto per profili persiana ALL.CO 5 1144 / 3184 / 1549 / 3184 EKIP 40 - EKIP EVOLUTION - ZK 10211 / ZK 8275 / ZK 12035	VI	97
099990234	Giunto per profilo persiana METRA - NC 40	VI	98
099990235	Giunto per profili persiana fascia bassa DOMAL GELOSIA - DOMAL GELOSIA 40	VI	96
099990236	Giunto per profili persiana GR 9 - NC 40 - METRA - SYNTHESIS - ALL.CO VZ 4274 / VZ 0643 - DOMAL	VI	97
099990237	Giunto per profilo persiana	VI	99
099990238	Giunto con collegamento ALLIANCE per profili persiana ALPHA 445 - R 40 900396 / 900619 900399 / 900261 / 900409	VI	97
099990279	Giunto per profili persiana ALL.CO 1494 / 3184 - METRA 3134 / 3138	VI	98
099990282	Giunto per profili persiana METRA FIRENZE - 4113 / 4026	VI	99
099990288	Leva per montaggio e smontaggio clips serie ALPHA 445 - GLOBO	V	80
099990290	Clips coprifilo EXPORT 50 - TRIALL.CO	I	11
099990294	Giunto per profilo persiana FB 12	VI	100
099990295	COCCINELLA chiusura per scurettili, cassonetti, bacheche, etc con spessori da mm 1 - 1,2 - 2 - 3	III	32
099990678	Copriangolo ALPHA 255	II	23
099990680	Giunto per profili persiana fascia alta DOMAL GELOSIA - DOMAL GELOSIA 40	VI	96
099990681	Rullo infila guarnizioni NEW TEC	V	78
099990685	Rullo passa cinghia UNIBLOCK prolungato EKIP - DOMAL - ALL.CO - R 40 - OCMA - EURO	I	10
099990694	Giunto per profili persiana DOMAL UNIVERSAL 55 21662 / 21663 - 21675	VI	96
099990695	Tappi terminali dx - sx per profilo persiana DOMAL UNIVERSAL 55 / 21662	II	17
099990698	Sella reversibile persiana fissa per lamella NACO SP 54 - R 40 / R 40 storico - ALPHA 445	VI	89
099990699	Tappi terminali dx - sx per profilo persiana DOMAL GELOSIA / 24457	II	17
099990814	Kit borchia tonda per pomolo PEGASO per fascia	IV	70
099990815	Kit borchia ovale per pomolo PEGASO per montante	IV	70
099990860	Tappi terminali dx - sx per profilo persiana DOMAL GELOSIA / 19663	II	17
099990861	Tappo terminale per profili persiana movimento DOMAL - R 40 - ALL.CO - ALPHA 445 - EKIP 40	II	17
099990897	Tassello di regolazione maggiorato per SUPER TOP GRILLO - SUPER MIDI GRILLO - SUPER MAXI GRILLO	I	4
099990914	Rondella per cardine diametro interno mm 12	III	39
099991100	Angolo di giunzione per controtelaio in lamiera zincata completo di prolunghe da mm 60 (lunghezza totale mm 138)	VI	108
099991101	Prolunga mm 30 angolo di giunzione per controtelaio in lamiera zincata	VI	108
099991102	Prolunga mm 20 angolo di giunzione per controtelaio in lamiera zincata	VI	108

CODICE	DESCRIZIONE	CAP	PAG
099991103	Rullo infilata guarnizioni ALL.CO WOOD - ALL.CO EXPORT 50 / 50 T.T. - EKU 53 - ALL.CO 45/45 TT - ALFIL A45/A45 RPT - ETA	V	76
099991104	Rullo infilata guarnizioni serie ALULEN THERMIC	V	78
099991110	Clips ferma vetro SISTEMA 1 TRAFILERIE EMILIANE	I	11
099991116	Sella reversibile persiana fissa per ovalina mm 50x10 DOMAL 21662 - DOMAL 40 / 19741 - GR 9 - R40 - ALPHA 445 - NEW TEC PQ 4875	VI	87
099991121	Giunto DOMAL BREAK PA 52 15109 / 15120	VI	97
099991122	Giunto DOMAL 40 19658 / 26174	VI	96
099991123	Tappi terminali dx - sx EQUIPE INVERSIONE	II	18
099991124	Tappi terminali dx - sx per profilo anta persiana rustica EQUIPE	II	18
099991125	Tappi terminali dx - sx per profilo anta persiana EQUIPE 8000	II	18
099991126	Giunto METRA - NC 45 INTERNATIONAL 3462 / 3654 / 3463	VI	99
099991127	Giunto R 40 800327 / 800325 - 800326 / 800331	VI	100
099991128	Chiave per rotazione blocchetto di assemblaggio (cod. 1638) profili legno / alluminio	V	80
099991413	Giunto ALL.CO 5 1520 / 5091 / 5092	VI	98
099991414	Giunto per profili persiana ALL.CO 5 VZ 3608 / VZ 3609	VI	98
099991415	Tappi terminali dx - sx per profili persiana EKLI - ALL.CO 5 VZ 3608	II	19
099991426	Spessore per giunti artt. 0122 - 1122	VI	96
099991429	Tappi terminali dx - sx per profilo persiana movimento METALTECNICA	II	21
099991430	Giunto per profilo persiana movimento METALTECNICA	VI	100
099991432	Giunto per profili persiana INDINVEST serie GOLD 400 40073 / 40072	VI	101
099991433	Giunto per profili persiana INDINVEST serie GOLD 400 40109 / 40110	VI	101
099991434	Tappi terminali dx - sx INDINVEST serie GOLD 400 / 40109 40073 - 40074	II	21
099991533	Sella reversibile persiana fissa per ovalina mm 65x10 EKIP 40 - METRA - GR 9 - NC - ALL.CO SPRINT P 4 - EURO 40 - SYNTHESIS - SISTEMA 1 - ALU ■ K 494	VI	91
099991535	Spessore mm 15 per mezza sella Artt. 1116 - 0058	VI	93
099991562	Blocchetto di assemblaggio per profili legno / alluminio (utilizzare chiave cod. 2896)	I	9
099991638	Blocchetto di assemblaggio per profili legno / alluminio (utilizzare chiave cod. 1128)	I	9
099991670	Giunto per profili persiana METRA - nuovo NC 40 3382 / 4359	VI	99
099991738	Rullo infilata guarnizioni EKIP EVOLUTION	V	77
099991741	Rullo infilata guarnizioni ABITHAL GREEN - ABITHAL KEEPER 53/60 ABITHAL KEEPER 60/68	V	79
099991800	Spessore angolare per vetro infilare	VI	108
099991804	Giunto ALL.CO - EXPORT 50 - 5097 / 5096	VI	98
099991805	Giunto DOMAL INDOOR 27503 / 27504	VI	95
099991806	Giunto per profilo persiana FB 12 a scomparsa	VI	100
099991807	Giunto per profilo persiana RIVIERA	VI	100
099991808	Sella reversibile persiana fissa per profili camera mm 14x35 lamella UNIVERSAL 55	VI	90
099991818	Distanziale aperto dx - sx mm 60 con bordino e spessore per lamella Kosmica mm 72,5 camera METALTECNICA	VI	95
099991824	Sella reversibile persiana fissa per ovalina mm 65x10 R40 - ALPHA 445 - DOMAL 21662 - DOMAL 40/19741 - GR 9 - NEW TEC PQ 4875	VI	91
099991826	Sella reversibile persiana fissa per ovalina mm 65x10 DOMAL GELOSIA - DOMAL 40 - DOMAL STOPPER PG - ALL.CO 5 / 1556	VI	91
099991829	Giunto per profilo persiana alla genovese METRA 3295	VI	99
099991830	Giunto per profilo persiana alla genovese METRA 3291	VI	99
099991837	Registro con vite da mm 10	VI	109
099991841	Registro con vite da mm 18	VI	109
099991863	Kit spessore angolare per vetro infilare e registro con vite da mm 10	VI	108
099991864	Kit spessore angolare per vetro infilare e registro con vite da mm 18	VI	109
099991881	Borchia ovale in resina OPACA per cilindro sagomato serie CRISTINA	IV	61
099991882	Borchia tonda in resina OPACA per cilindro sagomato serie CRISTINA	IV	62
099991884	Borchia tonda in resina OPACA per chiave PATENT serie CRISTINA	IV	62
099991896	Giunto per profili persiana DOMAL UNIVERSAL 55 21662 / 21663 - 21675	VI	97
099991897	Tappi terminali dx - sx per profili persiana EKLI - ALL.CO P4 VZ 0747	II	19
099991898	Tappi terminali dx - sx per profili persiana UNIVERSAL 55 - DOMAL GELOSIA 26211/26212 / 19724/19741	II	17
099991899	Tappi terminali dx - sx per profili persiana UNIVERSAL 55 - DOMAL 40 / 21688	II	17
099991900	Sella reversibile persiana fissa per ovalina mm 50x10 ALL.CO 5 VZ 3608 - ALL.CO P4 VZ 0747 / VZ 0739 - GOLD 400 / 40109	VI	88
099991901	Giunto per profili persiana ALL.CO P4 VZ 0747 / VZ 0748 - ALL.CO K40 - CE 024 / VZ 0748	VI	98
099991902	Borchia tonda in resina OPACA per cilindro ovale serie CRISTINA	IV	62
099991903	Borchia ovale in resina OPACA per cilindro ovale serie CRISTINA	IV	61

CODICE	DESCRIZIONE	CAP	PAG
099991905	Giunto per profili persiana EKU 53 T.E.S. 5680 / 5681	VI	101
099991906	Tappi terminali dx - sx per profilo persiana EKU 53 T.E.S. 5680	II	20
099991907	Tappi terminali dx - sx per profilo persiana EKU 53 T.E.S. 4263	II	20
099991908	Borchia ovale in resina LUCIDA per cilindro sagomato serie CRISTINA	IV	61
099991909	Borchia tonda in resina LUCIDA per cilindro sagomato serie CRISTINA	IV	62
099991910	Borchia tonda in resina LUCIDA per chiave PATENT serie CRISTINA	IV	62
099991911	Borchia tonda in resina LUCIDA per cilindro ovale serie CRISTINA	IV	62
099991912	Borchia ovale in resina LUCIDA per cilindro ovale serie CRISTINA	IV	61
099991962	Giunto per profili persiana GLOBAL AS 4580 / 4517	VI	101
099991963	Giunto per profili persiana R 40 900621 / 800365 - REVAMPING	VI	101
099991964	Tappi terminali dx - sx per profilo persiana R 40 / 800365	II	11
099991965	Tappi terminali dx - sx per profilo persiana R 40 / 900250 - 900658	II	14
099991966	Tappi terminali dx - sx per profilo persiana EKIP ZK 13737 / 38	II	15
099991980	Sella reversibile persiana fissa per profili camera mm 14x35 lamella centro storico Firenze	VI	93
099991981	Leva per montaggio e smontaggio clips serie GOLD INDINVEST	V	80
099991990	Rullo infila guarnizioni Z 106-111-113	V	79
099991999	Tappi terminali dx - sx per profilo persiana EKIP ZK 13739 / 40	II	15
099992021	Martellina CRISTINA in alluminio 7	IV	65
099992050	Rullo infila pinna GOLD 490	V	79
099992051	Sella reversibile persiana fissa per profili camera mm 14x35 lamella PERLA 70	VI	92
099992052	Giunto per profili persiana GOLD 400 40136 / 40138 / 40075 / 40076	VI	100
099992057	Rullo infila guarnizioni ALU-K serie 45 CO	V	79
099992058	Invito tapparella dx - sx DOMAL SPIDER L48/31145	I	10
099992060	Raccordo 30x30 a due vie	VI	113
099992061	Raccordo 30x30 a tre vie	VI	113
099992062	Raccordo 30x30 a quattro vie	VI	113
099992063	Raccordo 30x30 a cinque vie	VI	101
099992065	Giunto EKU 53 T.E.S. 4264 / 4276 - 4277 / 4278	VI	101
099992066	Giunto INDINVEST serie GOLD 400-500 - 40107 / 50049 - 40171 / 40172	VI	102
099992067	Tappi terminali dx - sx per profili persiana EKIP ZK 11286	II	16
099992068	Tappi terminali dx - sx per profili persiana EKIP ZK 11645	II	16
099992080	Sella reversibile persiana fissa per profili camera mm 12,5x36 lamella UNIVERSAL 55	VI	90
099992090	Sella reversibile persiana fissa per profili camera mm 12,5x36 lamella NACO SP 54	VI	90
099992091	Borchia tonda in alluminio per cilindro ovale serie CRISTINA	IV	64
099992092	Borchia tonda in alluminio per cilindro sagomato serie CRISTINA	IV	64
099992093	Borchia tonda in alluminio per chiave PATENT serie CRISTINA	IV	64
099992098	Maniglia TATA in resina ribassata con molla di ritorno	IV	66
099992099	Chiave per vite con cava esagonale mm 2	V	81
099992102	Chiave per vite con cava esagonale mm 4	V	81
099992103	Chiave per vite con cava esagonale mm 5	V	81
099992104	Chiave per vite con cava esagonale mm 6	V	82
099992105	Chiave per vite con cava esagonale mm 2,5	V	81
099992106	Chiave per vite con cava esagonale mm 3	V	81
099992110	Tappi terminali dx - sx per profili persiana DOMAL 27359	II	18
099992111	Tappi terminali dx - sx per profili persiana DOMAL 27362	II	18
099992113	Tappi terminali dx - sx per profili persiana ALL.CO 5 VZ 1481 / VZ 3606	II	19
099992114	Tappi terminali dx - sx per profili persiana ALL.CO P4 VZ 0635 / VZ 0749	II	19
099992119	Maniglia TATA in resina decentrata	IV	67
099992120	Blocchetto libero-occupato con quadro mm 6 x 82	IV	69
099992123	Tappi terminali dx - sx per profilo persiana EKIP 40 ZK 10211 / ZK 9452	II	16
099992124	Giunto per persiana DOMAL 26212 / 19735 / 26205 - ALUMEC - SISTEMA 1 4092 / 4037 / 4093	VI	95
099992125	Borchia sottile per chiave patent	IV	69
099992127	Rullo infila guarnizioni nuova serie ALULEN	V	78
099992128	BREZZA chiusura manuale per serramenti con anta a sporgere (dima di foratura cod. 2143)	III	35

CODICE	DESCRIZIONE	CAP	PAG
099992129	Kit chiavi per vite con cava esagonale (misure varie)	V	82
099992132	Maniglia TATA in resina con leva bassa per serratura persiana	IV	67
099992133	Cilindro di adattamento sagomato	IV	69
099992134	Cilindro di adattamento ovale	IV	69
099992136	Riduzione quadro serratura da mm 8 a mm 6	IV	69
099992139	Tappi terminali dx - sx per profili persiana ALL.CO - CE 024	II	20
099992140	Tappi terminali dx - sx per profili persiana ALL.CO - CE 003	II	20
099992146	Cerniera MINI mm 48 con spessore complanare da mm 1	III	40
099992147	Cerniera MEDIA mm 48 con spessore complanare da mm 1	III	40
099992148	Cerniera MAXI mm 48 complanare	III	39
099992149	Spessore complanare da mm 6 per cerniere MEDIA - MAXI	III	40
099992150	Spessore complanare da mm 2,5 per cerniere MEDIA e MINI	III	41
099992152	Cilindro di adattamento ovale (serrature CISA e similari)	IV	69
099992157	Comando chiusura persiana serie TATA in resina con quadro mm 6 x 82	IV	67
099992158	Rotella per squadretta zanzariera sistema scorrevole	VI	112
099992159	Frizione a due molle e compensatore per squadretta zanzariera simmetrica sistema saliscendi	VI	112
099992160	Squadretta polivalente per zanzariera asimmetrica sistema scorrevole o saliscendi con viti M5 x 9,5 (Brevettata)	VI	111
099992161	Tappi terminali dx - sx per profili persiana ALL.CO VZ 4303	II	19
099992169	Cerniera MINI rotazione 180°	III	41
099992170	Cerniera MEDIA rotazione 180°	III	41
099992171	Cerniera MAXI rotazione 180°	III	41
099992173	Snodo per cerniera MAXI, MEDIA, MINI da mm 48 per rotazione a 360° completo di perno	III	40
099992174	CHIOCCIOLA chiudi anta a tirare con spessore da mm 2,5 viti inox e tappi copriforo	III	33
099992175	Collegamento per giunti cod. 0233 - cod. 0236 EKIP EVOLUTION ZK 8275 / ZK 12035 - ALL.CO VZ 0643	VI	97
099992179	Spessore da mm 7,5 per SUPER TOP GRILLO - SUPER MIDI GRILLO - SUPER MAXI GRILLO	I	4
099992181	Borchia anti svitamento per SUPER TOP GRILLO - SUPER MIDI GRILLO - SUPER MAXI GRILLO	I	5
099992182	CHIOCCIOLA chiudi anta a tirare per infissi con spessore battuta minimo mm 18 con tappi copriforo	III	34
099992183	Vaschetta di riscontro per chiudi anta a spingere	III	33
099992184	Tappo terminale dx - sx per profili persiana R 40 / 800577 - 800645	II	14
099992187	Tappi terminali dx - sx per profili persiana DOMAL SUNNY 27394 - 27539	II	18
099992189	Spessore per CHIOCCIOLA da mm 2	III	33
099992190	Spessore per CHIOCCIOLA da mm 3	III	33
099992191	Blocchetto di assemblaggio per profili legno / alluminio	I	9
099992192	Borchia ovale in resina per cilindro sagomato serie TATA	IV	68
099992198	Tappi terminali dx - sx per profili persiana ALL.CO VZ 4366	II	19
099992213	Spessore da mm 14,5 per SUPER TOP GRILLO - SUPER MIDI GRILLO - SUPER MAXI GRILLO	I	5
099992560	Tappi terminali dx - sx INDINVEST 40075 / 40134	II	21
099992561	Tappi terminali dx - sx INDINVEST 40136	II	21
099992617	Cerniera per zanzariera a battente senza molla	III	36
099992618	Cerniera per zanzariera a battente con molla e perno di regolazione in zama	III	36
099992623	Coppia tappi riporto centrale inversione battuta R 40 REVAMPING con mezzaluna	II	23
099992709	Tavellino universale maniglia piccola con spessori di compensazione da mm 3-4-5	III	34
099992710	Tavellino universale maniglia grande con spessori di compensazione da mm 3-4-5	III	35
099992711	Cerniera per zanzariera a battente piana senza molla	III	37
099992712	Cerniera per zanzariera a battente piana con molla e perno di regolazione in zama	III	37
099992713	Cerniera per zanzariera a battente senza molla e guida da mm 11,6	III	37
099992714	Cerniera per zanzariera a battente con molla, perno di regolazione in zama e guida da mm 11,6	III	37
099992715	Cerniera per zanzariera a battente senza molla e guida da mm 13,3	III	38
099992716	Cerniera per zanzariera a battente con molla, guida da mm 13,3 e perno di regolazione in zama	III	38
099992717	Kit con dado farfalla zincato da mm 16,6 e vite inox M5 x 10	III	39
099992718	Kit con dado farfalla zincato da mm 19,5 e vite inox M5 x 10	III	39
099992719	Incontro asta singolo per camera da mm 14 con dado farfalla inox da mm 16,6 ABITHAL GREEN - DOMAL STOPPER - DOMAL BREAK - EKU 53 / 64 TT / 72 TT - EXPORT 45 / 45TT / 50 / 50 TT - GOLD 400 - K 40 - SYNTHESIS 45	III	53
099992720	Incontro asta singolo per camera da mm 14 con dado farfalla zincato da mm 16,6 ABITHAL GREEN - DOMAL STOPPER - DOMAL BREAK - EKU 53 / 64 TT / 72 TT - EXPORT 45 / 45TT / 50 / 50 TT - GOLD 400 - K 40 - SYNTHESIS 45	III	53

CODICE	DESCRIZIONE	CAP	PAG
09999 <b>2721</b>	Incontro asta singolo per camera da mm 14 con dado farfalla inox da mm 19,5 ALL.CO 5 - ALPHA 445 / 658 TT - EKIP 40 / 50 - EURO 40 - nuovo NC 40	III	53
09999 <b>2722</b>	Incontro asta singolo per camera da mm 14 con dado farfalla zincato da mm 19,5 ALL.CO 5 - ALPHA 445 / 658 TT - EKIP 40 / 50 - EURO 40 - nuovo NC 40	III	53
09999 <b>2723</b>	Incontro asta doppio per camera da mm 14 con dado farfalla inox da mm 16,6 ABITHAL GREEN - DOMAL STOPPER - DOMAL BREAK - EKU 53 / 64 TT / 72 TT - EXPORT 45 / 45TT / 50 / 50 TT - GOLD 400 - K 40 - SYNTHESIS 45	III	54
09999 <b>2724</b>	Incontro asta doppio per camera da mm 14 con dado farfalla zincato da mm 16,6 ABITHAL GREEN - DOMAL STOPPER - DOMAL BREAK - EKU 53 / 64 TT / 72 TT - EXPORT 45 / 45TT / 50 / 50 TT - GOLD 400 - K 40 - SYNTHESIS 45	III	54
09999 <b>2725</b>	Incontro asta dx - sx per camera da mm 15 con dado farfalla inox da mm 19,5 nuovo NC 40 - SISTEMA I	III	54
09999 <b>2726</b>	Incontro asta dx - sx per camera da mm 15 con dado farfalla zincato da mm 19,5 nuovo NC 40 - SISTEMA I	III	54
09999 <b>2727</b>	Terminale per asta da mm 16,5 con perno inox NC 45 INTERNATIONAL / SUPER THERMIC - NC 55 INTERNATIONAL NC 65 / 68 / 72 SUPER THERMIC	III	43
09999 <b>2728</b>	Terminale per asta da mm 16,5 con perno zincato NC 45 INTERNATIONAL / SUPER THERMIC - NC 55 INTERNATIONAL NC 65 / 68 / 72 SUPER THERMIC	III	43
09999 <b>2730</b>	Terminale per asta da mm 18 con ponte di collegamento per asta cremonese e perno zincato	III	43
09999 <b>2731</b>	Terminale per asta da mm 19,5 con perno inox DOMAL BREAK / GELOSIA / STOPPER PG - GOLD - ALL.CO K40 / 5TT / P4 / EXPORT - EKIP 40 - nuovo NC 40	III	45
09999 <b>2732</b>	Terminale per asta da mm 19,5 con perno zincato DOMAL BREAK / GELOSIA / STOPPER PG - GOLD - ALL.CO K40 / 5TT / P4 / EXPORT - EKIP 40 - nuovo NC 40	III	45
09999 <b>2733</b>	Terminale per asta da mm 18 con ponte di collegamento per asta cremonese e perno inox decentrato R 40 / R 50 TT / R 62 / R 72 - NEW TEC 50 / 52 / 60 / 68 ST - ESEDRA GA 53 - ESEDRA LIGHT 42 / 50 - ESEDRA TT 63 / TT 75	III	44
09999 <b>2734</b>	Terminale per asta da mm 18 con ponte di collegamento per asta cremonese e perno zincato decentrato R 40 / R 50 TT / R 62 / R 72 - NEW TEC 50 / 52 / 60 / 68 ST - ESEDRA GA 53 - ESEDRA LIGHT 42 / 50 - ESEDRA TT 63 / TT 75	III	44
09999 <b>2735</b>	Asta di comando da mm 16,5 con ponte di collegamento NC 45 INTERNATIONAL / SUPER THERMIC - NC 55 INTERNATIONAL - NC 65 / 68 / 72 SUPER THERMIC	III	42
09999 <b>2736</b>	Asta di comando da mm 18 con ponte di collegamento R 40 / R 50 TT / R 62 / R 72 - NEW TEC 50 / 52 / 60 - 68 ST - ESEDRA GA 53 - ESEDRA LIGHT 42 / 50 - ESEDRA TT 63 / TT 75	III	42
09999 <b>2737</b>	Asta di comando da mm 19,5 con ponte di collegamento DOMAL BREAK / GELOSIA / STOPPER PG - GOLD - ALL.CO K40 / 5TT / P4 / EXPORT - EKIP 40 - nuovo NC 40	III	42
09999 <b>2738</b>	Catenaccio da mm 16,5 con perno inox NC 45 INTERNATIONAL / SUPER THERMIC - NC 55 INTERNATIONAL - NC 65 / 68 / 72 SUPER THERMIC	III	47
09999 <b>2739</b>	Catenaccio da mm 16,5 con perno zincato NC 45 INTERNATIONAL / SUPER THERMIC - NC 55 INTERNATIONAL - NC 65 / 68 / 72 SUPER THERMIC	III	47
09999 <b>2742</b>	Catenaccio da mm 19,5 con perno inox DOMAL BREAK / GELOSIA / STOPPER PG - GOLD - ALL.CO K40 / 5TT / P4 / EXPORT - EKIP 40 - nuovo NC 40	III	50
09999 <b>2743</b>	Catenaccio da mm 19,5 con perno zincato DOMAL BREAK / GELOSIA / STOPPER PG - GOLD - ALL.CO K40 / 5TT / P4 / EXPORT - EKIP 40 - nuovo NC 40	III	50
09999 <b>2744</b>	Catenaccio da mm 18 con perno inox e ponte di collegamento per asta R 40 / R 50 TT / R 62 / R 72 - NEW TEC 50 / 52 / 60 / 68 ST - ESEDRA GA 53 - ESEDRA LIGHT 42 / 50 - ESEDRA TT 63 / TT 75	III	48
09999 <b>2745</b>	Catenaccio da mm 18 con perno zincato e ponte di collegamento per asta R 40 / R 50 TT / R 62 / R 72 - NEW TEC 50 / 52 / 60 / 68 ST - ESEDRA GA 53 - ESEDRA LIGHT 42 / 50 - ESEDRA TT 63 / TT 75	III	48
09999 <b>2747</b>	Maniglia CRISTINA in resina OPACA con borchia ovale e molla di ritorno (Brevettata)	IV	60
09999 <b>2748</b>	Maniglia CRISTINA in resina LUCIDA con borchia ovale e molla di ritorno (Brevettata)	IV	60
09999 <b>2749</b>	Maniglia CRISTINA in resina OPACA con borchia tonda e molla di ritorno (Brevettata)	IV	61
09999 <b>2750</b>	Maniglia CRISTINA in resina LUCIDA con borchia tonda e molla di ritorno (Brevettata)	IV	61
09999 <b>2751</b>	Maniglia TATA in resina con molla di ritorno	IV	66
09999 <b>2752</b>	BRUCO socchiudi finestra manuale a due ante con viti brunite	I	7
09999 <b>2753</b>	Maniglia CRISTINA in alluminio con borchia ovale e molla di ritorno (Brevettata)	IV	63
09999 <b>2754</b>	Maniglia CRISTINA in alluminio con borchia tonda e molla di ritorno (Brevettata)	IV	64
09999 <b>2755</b>	Maniglia CRISTINA in resina OPACA con borchia ovale senza molla di ritorno (Brevettata)	IV	60
09999 <b>2756</b>	Maniglia CRISTINA in resina LUCIDA con borchia ovale senza molla di ritorno (Brevettata)	IV	60
09999 <b>2757</b>	Maniglia CRISTINA in resina OPACA con borchia tonda senza molla di ritorno (Brevettata)	IV	62
09999 <b>2758</b>	Maniglia CRISTINA in resina LUCIDA con borchia tonda senza molla di ritorno (Brevettata)	IV	62
09999 <b>2759</b>	Maniglia TATA in resina con grano e molla di ritorno	IV	66
09999 <b>2764</b>	Spessori caricavetro ANGEL da mm 2 R 40 REVAMPING - R 50 TT	VI	104
09999 <b>2765</b>	Spessori caricavetro ANGEL da mm 5 R 40 REVAMPING - R 50 TT	VI	104
09999 <b>2766</b>	Spessori caricavetro ANGEL da mm 5,5 con foro R 40 REVAMPING - R 50 TT	VI	104
09999 <b>2767</b>	Spessori caricavetro ANGEL da mm 10,5 con foro R 40 REVAMPING - R 50 TT	VI	104
09999 <b>2768</b>	Borchia ovale in resina per chiave PATENT serie TATA	IV	68
09999 <b>2773</b>	Sella reversibile persiana fissa per profilo vetro ad infilare camera mm 25x24 max - 18 minimo per ovalina 50x10	VI	89
09999 <b>2774</b>	Mezza sella reversibile persiana fissa per profilo vetro ad infilare camera mm 25x24 max - 18 minimo per ovalina 50x10	VI	89

CODICE	DESCRIZIONE	CAP	PAG
099992777	Coppia tappi riporto centrale inversione battuta ALL.CO EXPORT 45 - 45 TT	II	24
099992778	Coppia tappi riporto centrale inversione battuta R 50 TT con mezzaluna	II	23
099992779	Coppia tappi riporto centrale inversione battuta R 50	II	23
099992781	Cerniera per zanzariera a battente senza molla con piastrino per profilo R40	III	36
099992782	Cerniera per zanzariera a battente con molla e piastrino con perno di regolazione in zama per profilo R40	III	36
099992784	Blister da 100 selle reversibili persiana fissa alla genovese per ovalina mm 50x10 FB 12 - METRA - ALL.CO - ALCAN - ABITHAL	VI	86
099992786	Coppia tappi riporto centrale inversione battuta ALL.CO 5 sormonto	II	24
099992787	Coppia tappi riporto centrale inversione battuta ALL.CO EXPORT 50	II	24
099992788	Coppia tappi riporto centrale inversione battuta ALL.CO EXPORT 50 TT	II	24
099992789	Incontro asta doppio con 2 grani inox EXPORT - EKU - GOLD	III	56
099992790	Incontro asta doppio con 1 grano inox SISTEMA 1 - nuovo NC 40	III	56
099992793	Coppia tappi riporto centrale inversione battuta ALL.CO WOOD	II	24
099992794	Terminale dx - sx per asta da mm 18 con ponte di collegamento per asta cremonese e perno piatto zincato R 40 / R 50 TT / R 62 / R 72 - NEW TEC 50 / 52 / 60 / 68 ST - ESEDRA GA 53 - ESEDRA LIGHT 42 / 50 - ESEDRA TT 63 / TT 75	III	44
099992795	Catenaccio da mm 18 con perno zincato piatto e ponte di collegamento per asta cremonese profili R 40 / R 50 TT / R 62 / R 72 - NEW TEC 50 / 52 / 60 / 68 ST - ESEDRA GA 53 - ESEDRA LIGHT 42 / 50 - ESEDRA TT 63 / TT 75	III	49
099992797	Coppia tappi riporto centrale inversione battuta nuovo NC 40 - METRA	II	25
099992798	Spessori caricavetro ANGEL da mm 5,5 con foro R 40 - R 50 giunto aperto	VI	104
099992799	CHIOCCIOLA chiudi anta a tirare con spessore da mm 2,5 viti inox e tappi copriforo	III	34
099992800	CHIOCCIOLA chiudi anta a spingere dx - sx con spessore da mm 2,5 viti inox e tappi copriforo	III	34
099992801	Squadretta di allineamento R 40 - R 50	VI	102
099992802	Terminale per asta da mm 19,5 con perno inox da mm 20 DOMAL BREAK / GELOSIA / STOPPER PG - GOLD - ALL.CO K40 / 5TT / P4 / EXPORT - EKIP 40 - nuovo NC 40	III	46
099992803	Terminale dx - sx per asta da mm 18 con ponte di collegamento per asta cremonese e perno inox da mm. 20 R 40 / R 50 TT / R 62 / R 72 - NEW TEC 50 / 52 / 60 / 68 ST - ESEDRA GA 53 - ESEDRA LIGHT 42 / 50 - ESEDRA TT 63 / TT 75	III	44
099992804	Catenaccio da mm 19,5 con perno inox e asta da mm 20 DOMAL BREAK / GELOSIA / STOPPER PG - GOLD - ALL.CO K40 / 5TT / P4 / EXPORT - EKIP 40 - nuovo NC 40	III	50
099992805	Catenaccio da mm 18 con perno inox da mm 20 R 40 / R 50 TT / R 62 / R 72 - NEW TEC 50 / 52 / 60 / 68 ST - ESEDRA GA 53 - ESEDRA LIGHT 42 / 50 - ESEDRA TT 63 / TT 75	III	48
099992806	Coppia tappi riporto centrale inversione battuta DOMAL 40	II	25
099992807	Coppia tappi riporto centrale inversione battuta DOMAL STOPPER PG 19664-23251	II	25
099992812	Incontro asta doppio con 2 grani inox ALL.CO 5 / 5 TT - R 40 / 50 TT / R 62 / R 72 - NEW TEC 50 / 52 / 60 / 68 ST - ESEDRA GA 53 - ESEDRA LIGHT 42 / 50 - ESEDRA TT 63 / TT 75	III	55
099992813	Coppia tappi riporto centrale inversione battuta R 40 dritto e arrotondato storico	II	24
099992814	Prolunga catenacci	III	51
099992815	Maniglia TATA in resina con leva alta per serratura persiana	IV	67
099992817	Kit anta singola DOMAL BREAK / GELOSIA / STOPPER PG - GOLD - ALL.CO K40 / 5TT / P4 / EXPORT - EKIP 40 - nuovo NC 40	III	51
099992818	Kit due ante DOMAL BREAK / GELOSIA / STOPPER PG - GOLD - ALL.CO K40 / 5TT / P4 / EXPORT - EKIP 40 - nuovo NC 40	III	52
099992822	Kit anta singola R 40 / R 50 TT / R 62 / R 72 - NEW TEC 50 / 52 / 60 / 68 ST - ESEDRA GA 53 - ESEDRA LIGHT 42 / 50 - ESEDRA TT 63 / TT 75	III	51
099992828	Coppia tappi riporto centrale inversione battuta R 40 dritto	II	24
099992838	Clips ferma vetro ALFIL 45 - DOMAL BREAK 70S	I	11
099992840	Squadretta di allineamento ETNALL ET4322 - G40/G2019 - ATLANTIS AZ 2109	VI	103
099992842	Kit anta fissa DOMAL BREAK / GELOSIA / STOPPER PG - GOLD - ALL.CO K40 / 5TT / P4 / EXPORT - EKIP 40 - nuovo NC 40	III	42
099992844	Cappetta drenaggio DOMAL 40 / BREAK / STOPPER - ALL.CO 5 - P4 - EXPORT 40 / 50 / 60	II	22
099992846	Squadretta di allineamento R 40	VI	102
099992847	Squadretta di allineamento chiusa R 40	VI	102
099992848	Coppia tappi riporto centrale inversione battuta DOMAL STOPPER PG 19663	II	25
099992849	Tappo ETNALL ET 4322 - G 40 / G2019 - ATLANTIS AZ 2109	II	23
099992850	Coppia tappi riporto centrale inversione battuta DOMAL BREAK PA 52	II	25
099992851	Asta di comando piatta da mm 18 R 40 / R 50 TT / R 62 / R 72 - NEW TEC 50 / 52 / 60 / 68 ST - ESEDRA GA 53 - ESEDRA LIGHT 42 / 50 - ESEDRA TT 63 / TT 75	III	43
099992852	Terminale dx - sx per asta da mm 18 con perno piatto zincato R 40 / R 50 TT / R 62 / R 72 - NEW TEC 50 / 52 / 60 / 68 ST - ESEDRA GA 53 - ESEDRA LIGHT 42 / 50 - ESEDRA TT 63 / TT 75	III	45
099992853	Catenaccio da mm 18 con perno zincato piatto R 40 / R 50 TT / R 62 / R 72 - NEW TEC 50 / 52 / 60 / 68 ST - ESEDRA GA 53 - ESEDRA LIGHT 42 / 50 - ESEDRA TT 63 / TT 75	III	49
099992854	Tappi terminali dx - sx ALL.CO P4 VZ 0785 / VZ 0755D	II	21
099992858	Astina sagomata per catenaccio DOMAL 40 terza anta	III	52

CODICE	DESCRIZIONE	CAP	PAG
09999 <b>2859</b>	Ponte di collegamento per catenaccio DOMAL 40 terza anta	III	53
09999 <b>2860</b>	Sella reversibile persiana fissa per profili vetro infilare camera 25x19,3 mm per ovalina mm 50x10	VI	89
09999 <b>2861</b>	Coppia blocchetto cremonese DOMAL BREAK / GELOSIA / STOPPER PG - GOLD - ALL.CO K40 / 5TT / P4 / EXPORT - EKIP 40 - nuovo NC 40	VI	103
09999 <b>2862</b>	Spessore zigrinato per vetrocamera mm 20x2	VI	104
09999 <b>2863</b>	Spessore zigrinato per vetrocamera mm 20x3	VI	105
09999 <b>2864</b>	Spessore zigrinato per vetrocamera mm 20x4	VI	105
09999 <b>2865</b>	Spessore zigrinato per vetrocamera mm 20x5	VI	105
09999 <b>2866</b>	Spessore zigrinato per vetrocamera mm 20x7	VI	105
09999 <b>2867</b>	Tappo a saldare per infissi in PVC con tubolare da mm. 40x40x1,5	VI	112
09999 <b>2870</b>	Kit da 20 selle reversibili persiana fissa alla genovese per ovalina mm 50x10 FB 12 - METRA - ALL.CO - ALCAN - ABITHAL	VI	86
09999 <b>2872</b>	Kit da 20 selle reversibili persiana fissa alla genovese per lamella centro storico mm 65x10	VI	92
09999 <b>2874</b>	Tappo a saldare per infissi in PVC con tubolare da mm. 40x40x2	VI	113
09999 <b>2879</b>	Squadretta polivalente per zanzariera asimmetrica sistema scorrevole o saliscendi con viti M5 x 11,4 (Brevetata)	VI	111
09999 <b>2886</b>	Tappo a saldare per infissi in PVC con tubolare da mm. 40x40x1	VI	112
09999 <b>2888</b>	Squadretta di allineamento alette ALL.CO 5 - ALL.CO P4	VI	102
09999 <b>2889</b>	Blocchetto sostegno piastra cerniera ALL.CO WOOD	VI	103
09999 <b>2893</b>	CLAC cricchetto con viti a vista e spessori di compensazione da mm 1-2-3-7	III	35
09999 <b>2894</b>	CLIC cricchetto con viti a scomparsa e spessori di compensazione da mm 1-2-3-7	III	35
09999 <b>2895</b>	Terminale per asta da mm 19,5 con perno inox da mm 20 DOMAL BREAK / GELOSIA / STOPPER PG - GOLD - ALL.CO K40 / 5TT / P4 / EXPORT - EKIP 40 - nuovo NC 40	III	47
09999 <b>2897</b>	Maniglia zanzariera per scorrevole e saliscendi	VI	112
09999 <b>2898</b>	Basamento con rotellina reggi anta (Scacciapensieri) con spessori vari	I	7
09999 <b>2899</b>	Terminale dx - sx per asta da mm 18 con perno inox da mm 20 R 40 / R 50 TT / R 62 / R 72 - NEW TEC 50 / 52 / 60 / 68 ST - ESEDRA GA 53 - ESEDRA LIGHT 42 / 50 - ESEDRA TT 63 / TT 75	III	45
09999 <b>2900</b>	Catenaccio da mm 18 con perno inox da mm 20 R 40 / R 50 TT / R 62 / R 72 - NEW TEC 50 / 52 / 60 / 68 ST - ESEDRA GA 53 - ESEDRA LIGHT 42 / 50 - ESEDRA TT 63 / TT 75	III	49
09999 <b>2904</b>	Catenaccio da mm 19,5 con perno inox e asta da mm 20	III	50
09999 <b>2905</b>	Coppia blocchetto cremonese R 40 - NEW TEC - NEW 50 / 52 TT / 60 TT	VI	103
09999 <b>2906</b>	Catenaccio per zanzariera da mm 16,5 con perno zincato bianco	III	47
09999 <b>2907</b>	Cappetta drenaggio per asola mm. 31x6	II	22
09999 <b>2916</b>	Profilo portaspazzolino da m 3 per camera da mm 25	II	26
09999 <b>2917</b>	Spessori da mm 2 per telaio / controtelaio	VI	107
09999 <b>2918</b>	Spessori da mm 3 per telaio / controtelaio	VI	107
09999 <b>2919</b>	Spessori da mm 5 per telaio / controtelaio	VI	107
09999 <b>2920</b>	Giunto con spessore nuovo NC - ETNALL ET43 - ATLANTIS serie 40 - G40	VI	102
09999 <b>2921</b>	Rullo infilare guarnizioni WIND STOP 45 TT / 55 TT (PONZIO)	V	78
09999 <b>2924</b>	Incontro asta con 2 grani inox e 2 boccole ALL.CO 5S / 5STT	III	55
09999 <b>2925</b>	Terminale per asta da mm 19,5 con perno inox Ø 8x20	III	46
09999 <b>2926</b>	Incontro asta singolo basso per camera da mm 14 con dado farfalla inox da mm 19,5 Persiana KL	III	53
09999 <b>2928</b>	Spessori da mm 4 per telaio / controtelaio	VI	107
09999 <b>2931</b>	Terminale per asta da mm 19,5 con punta rettangolare da mm 14 persiana KL	III	46
09999 <b>2935</b>	Distanziale aperto dx - sx per ovalina mm 50x10 persiana KL	VI	94
09999 <b>2936</b>	Compensatore dx - sx persiana KL	VI	93
09999 <b>2937</b>	Borchia ovale in alluminio per cilindro ovale serie CRISTINA	IV	63
09999 <b>2938</b>	Borchia ovale in alluminio per cilindro sagomato serie CRISTINA	IV	63
09999 <b>2939</b>	Borchia ovale in alluminio per chiave PATENT serie CRISTINA	IV	63
09999 <b>2940</b>	Cappetta drenaggio (fori Ø4 - interasse 48)	II	22
09999 <b>2952</b>	RENATO (Brevetato) braccio dx - sx per wasistas in alluminio DOMAL BREAK / GELOSIA / STOPPER PG - GOLD EXPORT - EKIP 40 - ALL.CO K40 / 5TT / P4 - nuovo NC40 - R40 / R 50TT / R 62 / R 72 - NEW TEC 50 / 52 / 60 / 68 ST - ESEDRA GA 53 - ESEDRA LIGHT 42/50 - ESEDRA TT 63 / TT 75	III	32
09999 <b>2953</b>	SCARABEO (Brevetato) chiusura per infissi a wasistas in alluminio con sormonto telaio - anta da mm 0 a 12 max e corda m 4	III	30
09999 <b>2954</b>	Coppia tappi riporto centrale EKU 45 17675	II	26
09999 <b>2955</b>	Tappi terminali dx - sx EKU 45 T.E.S. 17675	II	20
09999 <b>2956</b>	Tappi terminali dx - sx EKU 45 T.E.S. 17677 / 17678 ante	II	20
09999 <b>2957</b>	Spessore per maniglie serie CRISTINA con borchia ovale e maniglie TATA per profili arrotondati	IV	66



CODICE	DESCRIZIONE	CAP	PAG
099992960	Maniglia NUOVA EMOZIONE in resina con borchia ovale	IV	65
099992961	Cerniera per zanzariera a battente senza molla con denti da mm 14,6	III	38
099992962	Cerniera per zanzariera a battente con molla, denti da mm 14,6 e perno di regolazione in zama	III	38
099992963	Kit con dado farfalla zincato da mm 16,6 e vite inox TSP M5 x 8	III	39
099992964	PEPITO (Brevettato) fermo imposta automatico in acciaio inox	I	5
099992965	Kit copertura per SCARABEO verniciata	III	31
099992966	Kit spessori per SCARABEO stampato in nero	III	31
099992967	Invito tapparella	I	10
099992968	Kit spessori per SCARABEO verniciati	III	31
099992969	Incontro asta doppio basso per camera da mm 14 con dado farfalla inox da mm 19,5 Persiana KL	III	54
099992970	Distanziatore da mm Ø 15x16,5 R 40 - R 50 - ALL.CO 5 - ALL.CO P4 - ALPHA 445 / 545 / 658 TT	VI	105
099992971	Distanziatore da mm Ø 15x34 universale	VI	106
099992972	Distanziatore da mm Ø 19x16,5 TRIALCO - ALL.CO 5	VI	106
099992973	Distanziatore da mm Ø 25x21 ESEDRA - EXPORT - ALL.CO 5	VI	106
099992974	Distanziatore da mm Ø 15x20,5 nuovo NC 40 - NC 45 INTERNATIONAL - EKIP - EXPORT - DOMAL STOPPER	VI	105
099992975	Distanziatore da mm Ø 19x20,5	VI	106
099992976	Distanziatore da mm Ø 25x21 universale	VI	106
099992977	Invito tapparella	I	10
099992982	Borchia maxi per fermo imposte automatici	I	5
099992984	DIMA maschera di foratura per montaggio SCARABEO	III	30
099992988	Braccetto a scomparsa profili CAMERA EUROPEA - R40	I	7
099992989	Corda per SCARABEO da m 6	III	32
099992991	Riduttore per squadretta	VI	103
099992998	SCARABEO (Brevettato) chiusura per infissi a wasistas in legno e pvc con sormonto telaio - anta da mm 0 a 12 max e corda m 4	III	30
099992999	RENATO (Brevettato) braccio dx - sx per wasistas in legno o pvc	III	32
099993000	SUPER TOP GRILLO (Brevettato) fermo imposta automatico con vite da mm. 70	I	2
099993001	SUPER TOP GRILLO (Brevettato) fermo imposta automatico con vite da mm. 120	I	2
099993002	SUPER TOP GRILLO (Brevettato) fermo imposta automatico con ammortizzatore e vite da mm. 70	I	2
099993003	SUPER TOP GRILLO (Brevettato) fermo imposta automatico con ammortizzatore e vite da mm. 120	I	2
099993004	SUPER TOP GRILLO (Brevettato) fermo imposta automatico con tassello maggiorato e vite da mm. 70	I	2
099993005	SUPER TOP GRILLO (Brevettato) fermo imposta automatico con tassello maggiorato e vite da mm. 120	I	2
099993006	SUPER TOP GRILLO (Brevettato) fermo imposta automatico con tassello maggiorato, ammortizzatore e vite da mm. 70	I	2
099993007	SUPER TOP GRILLO (Brevettato) fermo imposta automatico con tassello maggiorato, ammortizzatore e vite da mm. 120	I	2
099993008	SUPER MIDI GRILLO (Brevettato) fermo imposta automatico con vite da mm. 70	I	3
099993009	SUPER MIDI GRILLO (Brevettato) fermo imposta automatico con vite da mm. 120	I	3
099993010	SUPER MIDI GRILLO (Brevettato) fermo imposta automatico con ammortizzatore e vite da mm. 70	I	3
099993011	SUPER MIDI GRILLO (Brevettato) fermo imposta automatico con ammortizzatore e vite da mm. 120	I	3
099993012	SUPER MAXI GRILLO (Brevettato) fermo imposta automatico doppia anta con vite da mm. 70	I	4
099993013	SUPER MAXI GRILLO (Brevettato) fermo imposta automatico doppia anta con vite da mm. 120	I	4
099993015	SUPER MAXI GRILLO (Brevettato) fermo imposta automatico doppia anta con ammortizzatore e vite da mm. 70	I	4
099993016	SUPER MAXI GRILLO (Brevettato) fermo imposta automatico doppia anta con ammortizzatore e vite da mm. 120	I	4
099993018	SUPER TOP GRILLO (Brevettato) fermo imposta automatico con tassello di regolazione maxi e vite da mm. 70	I	3
099993019	SUPER TOP GRILLO (Brevettato) fermo imposta automatico con tassello di regolazione maxi, ammortizzatore e vite da mm. 70	I	3
099993020	SUPER MIDI GRILLO (Brevettato) fermo imposta automatico con ammortizzatore e vite da mm. 150	I	3
099993021	Supporto gancio telaio perimetrale	III	56
099993022	Distanziale anta s/tradizionale mm 17,3x7,3	III	56
099993023	Distanziale anta mm 23,3x14	III	57
099993024	Distanziale anta mm 23,3x11	III	57
099993027	Catenaccio da mm 18 con perno zincato e ponte di collegamento per asta	III	48
099993028	Kit copertura per SCARABEO stampato in nero	III	31
099993034	Chiave piegata per rotazione blocchetto di assemblaggio (cod. 1638) profili legno / alluminio	V	81
099993035	SUPER TOP GRILLO (Brevettato) fermo imposta automatico con vite da mm. 150	I	2
099993036	SUPER TOP GRILLO (Brevettato) fermo imposta automatico con ammortizzatore e vite da mm. 150	I	2

CODICE	DESCRIZIONE	CAP	PAG
09999 <b>3037</b>	SUPER MAXI GRILLO (Brevettato) fermo imposta automatico doppia anta con vite da mm. 150	I	4
09999 <b>3039</b>	Coppia blocchetto cremonese maggiorato	VI	103
09999 <b>3042</b>	Distanziale anta mm 27,7x10,2	III	57
09999 <b>3047</b>	Sella reversibile persiana fissa per profili camera mm 36x17 ovalina mm 50x10	VI	88
09999 <b>3048</b>	Compensatore dx - sx persiana fissa per profili camera mm 36x17 ovalina mm 50x10	VI	88
09999 <b>3049</b>	Supporto gancio telaio aperto mm 9,8x10	III	57
09999 <b>3050</b>	Supporto gancio telaio aperto mm 7x12	III	57
29999 <b>0825</b>	Manico per rullo infila guarnizioni a due bracci	V	79
29999 <b>0827</b>	Manico per rullo infila guarnizioni a un braccio	V	79
31000 <b>8800</b>	Asta AVP $\varnothing$ 8	IV	71
69999 <b>0129</b>	Tappo semitondo piccolo	VII	119
69999 <b>0149</b>	Coppia ganci per tenda	VII	119
69999 <b>0150</b>	Cappello da prete o battuta di riscontro	VII	124
69999 <b>0155</b>	Blocchetto guida 40x18	VII	117
69999 <b>0156</b>	Riscontro a scatto GR 9	VII	116
69999 <b>0157</b>	Copriangolo GR 9	VII	116
69999 <b>0158</b>	Copriangolo NC 40-50	VII	116
69999 <b>0159</b>	Tappo 20x10	VII	120
69999 <b>0160</b>	Tappo copriforo $\varnothing$ 12	VII	117
69999 <b>0161</b>	Tappo copriforo $\varnothing$ 14	VII	117
69999 <b>0163</b>	Tappo 50x50	VII	122
69999 <b>0164</b>	Tappo 25x25	VII	120
69999 <b>0165</b>	Tappo 30x30	VII	121
69999 <b>0166</b>	Tappo 20x20	VII	120
69999 <b>0167</b>	Tappi corrimano	VII	118
69999 <b>0168</b>	Tappo 40x20	VII	121
69999 <b>0169</b>	Riscontro a scatto NC	VII	116
69999 <b>0172</b>	Blocchetto guida 50x25	VII	117
69999 <b>0173</b>	Rondella cerniera diametro interno mm 11	VII	118
69999 <b>0174</b>	Tappo 20x80	VII	120
69999 <b>0175</b>	Tappo 40x60	VII	121
69999 <b>0176</b>	Riscontro universale	VII	116
69999 <b>0177</b>	Tappo trapezoidale piccolo	VII	119
69999 <b>0178</b>	Copribattuta GR 9	VII	116
69999 <b>0179</b>	Copribattuta NC 40-50	VII	117
69999 <b>0180</b>	Tappo 30x20	VII	121
69999 <b>0182</b>	Tappo 30x60	VII	121
69999 <b>0183</b>	Tappo 15x30	VII	119
69999 <b>0184</b>	Tappo 20x100	VII	120
69999 <b>0185</b>	Blocchetto guida 40x19 GR 9	VII	117
69999 <b>0187</b>	Tappo trapezoidale grande	VII	119
69999 <b>0188</b>	Tappo 40x40	VII	121
69999 <b>0189</b>	Boccola per riscontro $\varnothing$ 6	VII	118
69999 <b>0190</b>	Tappo 40x80	VII	122
69999 <b>0349</b>	Forbici in metallo LÖWE	VII	124
69999 <b>0634</b>	Tappo 15x80	VII	119
69999 <b>0824</b>	Tappo 25x50	VII	120
69999 <b>0950</b>	Squadretta telaio di scorrimento per zanzariera scorrevole e saliscendi	VII	123
69999 <b>0954</b>	Tassello compensatore per zanzariera scorrevole e saliscendi	VII	123
69999 <b>0967</b>	Cilindro parapolvere $\varnothing$ 6	VII	124
69999 <b>0968</b>	Cilindro parapolvere $\varnothing$ 8	VII	124
69999 <b>0969</b>	Cilindro parapolvere $\varnothing$ 10	VII	124
69999 <b>1510</b>	Perno cerniera $\varnothing$ 11	VII	118



# ANALYTICAL INDEX



CODE	DESCRIPTION	CHA	PAG
00637 <b>2890</b>	Reversible saddle for fixed shutter lamella centro storico Firenze mm 65x9 ALL.CO camera mm 14x35	VI	93
01032 <b>2890</b>	Reversible saddle for fixed shutter lamella centro storico Firenze mm 65x10 DEMAL camera mm 14x35	VI	92
09999 <b>0005</b>	CICALONE part shutter for one leaf window	I	7
09999 <b>0006</b>	MINI GRILLO third leaf automatic shutter lock	I	6
09999 <b>0007</b>	CALABRONE manual shutter lock with 70 mm screw	I	6
09999 <b>0009</b>	FARFALLA manual shutter lock with 70mm screw	I	6
09999 <b>0010</b>	Right-Left open spacer, 39 mm, with flange and thickness for 50x10 mm opaline	VI	95
09999 <b>0012</b>	Transmission belt UNIBLOCK with plate and screws	I	7
09999 <b>0013</b>	40 - 50 pallet guide rod	I	8
09999 <b>0014</b>	Drip cover	II	21
09999 <b>0017</b>	Terminal plug for shutter profile NC 40	II	16
09999 <b>0018</b>	Right - left terminal plugs for shutter profile METRA - R 3553	II	15
09999 <b>0019</b>	Right - Left close spacer, 45.5 mm, for 50x10 mm opaline	VI	94
09999 <b>0020</b>	Terminal plug for shutter profile NC 40 extended	II	16
09999 <b>0022</b>	Right - Left open spacer, 40 mm, for 50x10 mm opaline	VI	94
09999 <b>0023</b>	Terminal plug for shutter profiles R 40 / 900396 - ALL.CO / 1494	II	14
09999 <b>0024</b>	Terminal plug for NACO camera shutter profile EKIP 40 / 10211 extended - NC 40 extended	II	15
09999 <b>0025</b>	Right - Left open spacer, 39 mm, with thickness for 50x10 mm opaline	VI	94
09999 <b>0026</b>	Terminal plug for shutter profiles R 40 / 900399 - ALL.CO 5	II	14
09999 <b>0027</b>	Reversible saddle (1st type) for genovese fixed shutter for 50x10 mm ovaline for FB 12 - METRA - ALL.CO - ALCAN - ABITHAL etc.	VI	86
09999 <b>0028</b>	Roller for gasket insertion for universal open joint	V	78
09999 <b>0029</b>	Reversible saddle for genovese fixed shutter for 60x10 mm opaline FB 12 - METRA - ALL.CO - ALCAN - ABITHAL	VI	90
09999 <b>0030</b>	Terminal plug for shutter profile ALPHA 445 - ALL.CO 1488/1569	II	16
09999 <b>0032</b>	Block rod Ø 6 for shutter with top-hung hinges	I	8
09999 <b>0033</b>	Plug for 10x50 oval profile	II	16
09999 <b>0040</b>	Small drawn bar in aluminium, 160 mm, with round boss	IV	71
09999 <b>0041</b>	Small drawn bar in aluminium, 270 mm, with round boss	IV	72
09999 <b>0042</b>	Right-Left open spacer, 39 mm, with thickness for 50x10 mm opaline	VI	94
09999 <b>0043</b>	Small drawn bar in aluminium, 320 mm, with round boss	IV	72
09999 <b>0044</b>	Small drawn bar in aluminium, 160 mm, with oval boss	IV	71
09999 <b>0045</b>	Small drawn bar in aluminium, 270 mm, with oval boss	IV	71
09999 <b>0046</b>	Small drawn bar in aluminium, 320 mm, with oval boss	IV	72
09999 <b>0049</b>	PEGASO knob in aluminium with round boss	IV	70
09999 <b>0052</b>	Counterplate	I	10
09999 <b>0054</b>	Terminal plug for "genovese" shutter profile FB 12 - METRA - ALL.CO	II	14
09999 <b>0056</b>	Small spatula for glass lifting	V	80
09999 <b>0057</b>	Big spatula for glass lifting	V	80
09999 <b>0058</b>	Reversible saddle for fixed shutter for 50x10 mm opaline R 40 - ALPHA 455	VI	88
09999 <b>0059</b>	Reversible saddle for fixed shutter for 50x10 mm opaline ALL.CO 1494 / 1549	VI	87
09999 <b>0060</b>	Cutter for packing and glass-stop gasket insertion	V	80
09999 <b>0061</b>	Reversible saddle for genovese fixed shutter for 50x10 mm opaline FB 12 - METRA - ALL.CO - ALCAN - ABITHAL	VI	86
09999 <b>0063</b>	Terminal plug for exented genovese shutter profile FB 12 - METRA - ALL.CO - GLOBAL	II	15
09999 <b>0068</b>	Fixed ledge cylinder (eccentric)	I	8
09999 <b>0069</b>	Reversible saddle for fixed shutterfor 50x10 mm opaline EKIP 40 - METRA - GR 9 - NC - ALL.CO SPRINT P 4 - EURO 40 - SYNTHESIS - SISTEMA 1 - ALU ■ K 494 - ALL.CO 1494/1549	VI	87
09999 <b>0072</b>	Reversible saddle for fixed shutter for 50x10 mm opaline DOMAL GELOSIA - DOMAL 40 - DOMAL STOPPER PG - ALL.CO 5/1556	VI	87
09999 <b>0078</b>	Right-Left open spacer, 39 mm, with flange and thickness for 50x10 mm opaline	VI	94
09999 <b>0080</b>	PEGASO knob in aluminium with oval boss	IV	70
09999 <b>0081</b>	Oval boss for oval cylinder	IV	68
09999 <b>0082</b>	Thin boss for shaped cylinder	IV	68
09999 <b>0094</b>	Oval boss for shaped cylinder	IV	68

CODE	DESCRIPTION	CAP.	PAG
099990095	Adjustable striker for Ø 6 rod	III	55
099990096	Thin boss for oval cylinder	IV	68
099990098	Striker bushing for Ø 6 rod	I	8
099990099	LIBELLULA manual shutter lock with 70 mm screw	I	6
099990100	Junction corner for aluminium soffit	VI	107
099990102	Right-Left open spacer, 49 mm, with flange and thickness for 65x10 mm opaline	VI	95
099990103	Right-Left open spacer, 49 mm, with flange and thickness for 65x10 mm opaline	VI	95
099990104	Reversible saddle for genovese fixed shutter for 65x10 mm opaline FB 12 - METRA - ALL.CO - ALCAN - ABITHAL	VI	91
099990105	Roller for gasket insertion R 40 / 50 - GLOBAL - ALL.CO 5 overlapped	V	76
099990106	Roller for gasket insertion for door prechamber R 40 / 50 stiff	V	76
099990107	Roller for gasket insertion EKIP 50	V	77
099990108	Roller for gasket insertion EKIP 40	V	77
099990109	Roller for gasket insertion DECORA - SISTEMA 1 - SISTEMA 2 WOOD (PROFILATI s.p.a. T.E.S.)	V	78
099990110	Roller for gasket insertion new - NC 40	V	77
099990111	Roller for gasket insertion for mosquito net	V	76
099990112	Roller for gasket insertion ALL.CO 5 coplanar	V	76
099990113	Roller for gasket insertion ALPHA 255 / 445 - BLITZ	V	76
099990114	Roller for gasket insertion NC 45 SUPERTHERMIC - NC 45 INTERNATIONAL	V	77
099990116	Roller for gasket insertion DOMAL STOPPER - SYNTHESIS	V	77
099990122	Joint DOMAL STOPPER PG	VI	96
099990123	Terminal plug for shutter profile EKIP 40 / 8146 - METRA	II	15
099990127	Window frame clip series ALPHA 445 - GLOBO	I	11
099990194	Right - left terminal plugs for shutter profile ALL.CO VZ 3466	II	22
099990195	Plug ALL.CO VZ 1255	II	23
099990196	Reversible saddle for genovese fixed shutter lamella centro storico mm 65x10	VI	92
099990233	Joint for shutter profiles ALL.CO 5 1144 / 3184 / 1549 / 3184 - EKIP 40 - EKIP EVOLUTION - ZK 10211 / ZK 8275 / ZK 12035	VI	97
099990234	Joint for shutter profile METRA - NC 40	VI	98
099990235	Joint for low-band shutter profiles DOMAL GELOSIA - DOMAL GELOSIA 40	VI	96
099990236	Joint for shutter profiles GR 9 - NC 40 - METRA - SYNTHESIS - ALL.CO VZ 4274 / VZ 0643 - DOMAL	VI	97
099990237	Joint for shutter profile	VI	99
099990238	Joint for ALLIANCE connection for shutter profiles ALPHA 445 - R 40 900396 / 900619 900399 / 900261 / 900409	VI	97
099990279	Joint for shutter profiles ALL.CO 1494 / 3184 - METRA 3134 / 3138	VI	98
099990282	Joint for shutter profiles METRA FIRENZE 4113 / 4026	VI	99
099990288	Lever to assemble and disassemble clips series ALPHA 445 - GLOBO	V	80
099990290	Coverwire clips EXPORT 50 - TRIALL.CO	I	11
099990294	Joint for shutter profile FB 12	VI	100
099990295	COCCINELLA lock for shutters, boxes, notice boards etc., with 1 - 1.2 - 2 - 3 mm thicknesses	III	32
099990678	Cover angle ALPHA 255	II	23
099990680	Joint for high-band shutter profiles DOMAL GELOSIA - DOMAL GELOSIA 40	VI	96
099990681	Roller for gasket insertion NEW TEC	V	78
099990685	Extended transmission belt UNIBLOCK EKIP - DOMAL - ALL.CO - R 40 - OCMA - EURO	I	10
099990694	Joint for shutter profiles DOMAL UNIVERSAL 55 21662 / 21663 - 21675	VI	96
099990695	Right - left terminal plugs for shutter profile DOMAL UNIVERSAL 55 / 21662	II	17
099990698	Reversible saddle for fixed shutter per lamella NACO SP 54 R 40 - R 40 storic - ALPHA 445	VI	89
099990699	Right - left terminal plugs for shutter profile DOMAL GELOSIA / 24457	II	17
099990814	Kit for round boss for PEGASO knob for band	IV	70
099990815	Kit for oval boss for PEGASO knob for leg	IV	70
099990860	Right - left terminal plugs for shutter profile DOMAL GELOSIA / 19663	II	17
099990861	Terminal plug for DOMAL movement shutter profile R 40 - ALL.CO - ALPHA 445 - EKIP 40	II	17
099990897	Extended regulator plug SUPER TOP GRILLO - SUPER MIDI GRILLO - SUPER MAXI GRILLO	I	4
099990914	Washer for 12 mm internal diameter pinte	III	39
099991100	Junction corner for counter frame in galvanized plate, provided with 60 mm extensions (total length mm 138)	VI	108
099991101	Extensions, 30 mm, junction corner for counterframe in galvanized plate	VI	108
099991102	Extensions, 20 mm, junction corner for counterframe in galvanized plate	VI	108

CODE	DESCRIPTION	CHA	PAG
099991103	Roller for gasket insertion ALL.CO WOOD - ALL.CO EXPORT 50 / 50 T.T. - EKU 53 - ALL.CO 45/45 TT - ALFIL A45/A45 RPT - ETA	V	76
099991104	Roller for gasket insertion series ALULEN THERMIC	V	78
099991110	Window frame clip series SISTEMA 1 TRAFILERIE EMILIANE	I	11
099991116	Reversible saddle for fixed shutter for 50x10 mm opaline DOMAL 21662 - DOMAL 40 / 19741 - GR 9 - R40 - ALPHA 445 - NEW TEC PQ 4875	VI	87
099991121	Joint DOMAL BREAK PA 52 15109 / 15120	VI	97
099991122	Joint DOMAL 40 19658 / 26174	VI	96
099991123	Right - left terminal plugs EQUIPE INVERSIONE	II	18
099991124	Right - left terminal plugs for country-style shutter profile EQUIPE	II	18
099991125	Right - left terminal plugs for serial shutter profile EQUIPE 8000	II	18
099991126	Joint METRA - NC 45 INTERNATIONAL 3462 / 3654 / 3463	VI	99
099991127	Joint R 40 800327 / 800325 - 800326 / 800331	VI	100
099991128	Rotation key of assembly block (code 1638) wood / aluminium profiles	V	80
099991413	Joint ALL.CO 5 1520 / 5091 / 5092	VI	98
099991414	Joint for shutter profiles ALL.CO 5 VZ 3608 / VZ 3609	VI	98
099991415	Right - left terminal plugs for shutter profile EKLI - ALL.CO 5 VZ 3608	II	19
099991426	Thickness for joints art. 0122 - 1122	VI	96
099991429	Right - left terminal plug for METALTECNICA movement shutter profile	II	21
099991430	Joint for shutter profile, METALTECNICA movement	VI	100
099991432	Joint for shutter profiles INDINVEST series GOLD 400 40073 / 40072	VI	101
099991433	Joint for shutter profiles INDINVEST series GOLD 400 40109 / 40110	VI	101
099991434	Right - left terminal plugs INDINVEST series GOLD 400 / 40109 40073 - 40074	II	21
099991533	Reversible saddle for fixed shutter for 65x10 mm opaline EKIP 40 - METRA - GR 9 - NC - ALL.CO SPRINT P 4 - EURO 40 - SYNTHESIS - SISTEMA 1 - ALU ■ K 494 - ALL.CO 1494/1549	VI	91
099991535	15 mm thickness for half saddle art. 1116 - 0058	VI	93
099991562	Assembly Block for wood/aluminium profiles (to use key cod. 2896 )	I	9
099991638	Assembly Block for wood/aluminium profiles (to use key cod. 1128)	I	9
099991670	Joint for shutter profiles METRA - new NC 40 3382 / 4359	VI	99
099991738	Roller for gasket insertion EKIP EVOLUTION	V	77
099991741	Roller for gasket insertion ABITHAL GREEN - ABITHAL KEEPER 53/60 - ABITHAL KEEPER 60/68	V	79
099991800	Angular thickness for thread glass	VI	108
099991804	Joint ALL.CO - EXPORT 50 - 5097 / 5096	VI	98
099991805	Joint DOMAL INDOOR 27503 / 27504	VI	95
099991806	Joint for shutter profile FB 12 hidden	VI	100
099991807	Joint for shutter profile RIVIERA	VI	100
099991808	Reversible saddle for fixed shutter for profiles 14x35 mm camera lamella UNIVERSAL 55	VI	90
099991818	Right-Left open spacer, 60 mm, with flange and thickness for lamella Kosmica mm 72,5 camera METALTECNICA	VI	95
099991824	Reversible saddle for fixed shutter for 65x10 mm opaline R40 - ALPHA 445 - DOMAL 21662 - DOMAL 40/19741 - GR 9 NEW - TEC PQ 4875	VI	91
099991826	Reversible saddle for fixed shutter for 65x10 mm opaline DOMAL GELOSIA - DOMAL 40 - DOMAL STOPPER PG - ALL.CO 5 / 1556	VI	91
099991829	Joint for genovese shutter profile METRA 3295	VI	99
099991830	Joint for genovese shutter profile METRA 3291	VI	99
099991837	Register with screw with 10 mm screw	VI	109
099991841	Register with 18 mm screw	VI	109
099991863	Kit for angular thickness for thread glass and register with 10 mm screw	VI	108
099991864	Kit for angular thickness for thread glass and register with 18 mm screw	VI	109
099991881	Oval boss in MATT resin for shaped cylinder of CRISTINA series	IV	61
099991882	Round boss in MATT resin for shaped cylinder of CRISTINA series	IV	62
099991884	Round boss in MATT resin for PATENT key of CRISTINA series	IV	62
099991896	Joint for shutter profiles DOMAL UNIVERSAL 55 21662 / 21663 - 21675	VI	97
099991897	Right - left terminal plugs for shutter profile EKLI - ALL.CO P4 VZ 0747	II	19
099991898	Right - left terminal plugs for shutter profile UNIVERSAL 55 - DOMAL GELOSIA 26211/26212 19724/19741	II	17
099991899	Right - left terminal plugs for shutter profile UNIVERSAL 55 - DOMAL 40 / 21688	II	17
099991900	Reversible saddle for fixed shutter for 50x10 mm ovaliner ALL.CO 5 VZ 3608 - ALL.CO P4 VZ 0747 / VZ 0739 - GOLD 400 / 40109	VI	88
099991901	Joint for shutter profiles ALL.CO P4 VZ 0747 / VZ 0748 - ALL.CO K40 - CE 024 / VZ 0748	VI	98
099991902	Round boss in MATT resin for oval cylinder of CRISTINA series	IV	62
099991903	Oval boss in MATT resin for oval cylinder of CRISTINA series	IV	61

CODE	DESCRIPTION	CHA	PAG
099991905	Joint for shutter profiles EKU 53 T.E.S. 5680 / 5681	VI	101
099991906	Right - left terminal plugs for shutter profile EKU 53 T.E.S. 5680	II	20
099991907	Right - left terminal plugs for shutter profile EKU 53 T.E.S. 4263	II	20
099991908	Oval boss in BRIGHT resin for shaped cylinder of CRISTINA series	IV	61
099991909	Round boss in BRIGHT resin for shaped cylinder of CRISTINA series	IV	62
099991910	Round boss in BRIGHT resin for PATENT key of CRISTINA series	IV	62
099991911	Round boss in BRIGHT resin for oval cylinder of CRISTINA series	IV	62
099991912	Oval boss in BRIGHT resin for oval cylinder of CRISTINA series	IV	61
099991962	Joint for shutter profiles GLOBAL AS 4580 / 4517	VI	101
099991963	Joint for shutter profiles R 40 900621 / 800365 - REVAMPING	VI	101
099991964	Right - left terminal plugs for shutter profile R 40 / 800365	II	11
099991965	Right - left terminal plugs for shutter profile R 40 / 900250 - 900658	II	14
099991966	Right - left terminal plugs for shutter profile EKIP ZK 13737 / 38	II	15
099991980	Reversible saddle for fixed shutter for profiles mm 14x35 camera lamella centro storico Firenze	VI	93
099991981	Lever to assemble and disassemble clips series GOLD INDINVEST	V	80
099991990	Roller for gasket insertion Z 106-111-113	V	79
099991999	Right - left terminal plugs for shutter profile EKIP ZK 13739 / 40	II	15
099992021	CRISTINA cremone bolt handle in aluminium $\nabla$ 7	IV	65
099992050	Roller for fin GOLD 490	V	79
099992051	Reversible saddle for fixed shutter for profiles 14x35 mm camera lamella PERLA 70	VI	92
099992052	Joint for shutter profiles GOLD 400 40136 / 40138 / 40075 / 40076	VI	100
099992057	Roller for gasket insertion ALU-K series 45 CO	V	79
099992058	Right - left shutter guide DOMAL SPIDER L48/31145	I	10
099992060	Two-way 30x30 fitting	VI	113
099992061	Three-way 30x30 fitting	VI	113
099992062	Four-way 30x30 fitting	VI	113
099992063	Five-way 30x30 fitting	VI	101
099992065	Joint EKU 53 T.E.S. 4264 / 4276 - 4277 / 4278	VI	101
099992066	Joint INDINVEST series GOLD 400-500 40107 / 50049 - 40171 / 40172	VI	102
099992067	Right - left terminal plugs for shutter profile EKIP ZK 11286	II	16
099992068	Right - left terminal plugs for shutter profile EKIP ZK 11645	II	16
099992080	Reversible saddle for fixed shutter for profiles 12.5x36 mm camera lamella UNIVERSAL 55	VI	90
099992090	Reversible saddle for fixed shutter for profiles 12.5x36 mm camera lamella NACO SP 54	VI	90
099992091	Round boss in aluminium for oval cylinder of CRISTINA series	IV	64
099992092	Round boss in aluminium for shaped cylinder of CRISTINA series	IV	64
099992093	Round boss in aluminium for PATENT key of CRISTINA series	IV	64
099992098	TATA handle in recessed resin with return spring	IV	66
099992099	Allen wrench mm 2	V	81
099992102	Allen wrench mm 4	V	81
099992103	Allen wrench mm 5	V	81
099992104	Allen wrench mm 6	V	82
099992105	Allen wrench mm 2.5	V	81
099992106	Allen wrench mm 3	V	81
099992110	Right - left terminal plugs for shutter profile DOMAL 27359	II	18
099992111	Right - left terminal plugs for shutter profile DOMAL 27362	II	18
099992113	Right - left terminal plugs for shutter profile ALL.CO 5 VZ 1481 / VZ 3606	II	19
099992114	Right - left terminal plugs for shutter profile ALL.CO P4 VZ 0635 / VZ 0749	II	19
099992119	TATA handle in decentered resin	IV	67
099992120	Vacant - engaged lock 6 x 82 mm frame	IV	69
099992123	Right - left terminal plugs for shutter profile EKIP 40 ZK 10211 / ZK 9452	II	16
099992124	Joint for shutter DOMAL 26212 / 19735 / 26205 - ALUMEC - SISTEMA 1 4092 / 4037 / 4093	VI	95
099992125	Thin boss for patent key	IV	69
099992127	Roller for gasket insertion nuova new series nueva serie ALULEN	V	78
099992128	BREZZA manual lock for window and door frames with protruding door (panel cutout code 2143)	III	35

CODE	DESCRIPTION	CHA	PAG
09999 <b>2129</b>	Kit of Allen wrenches	V	82
09999 <b>2132</b>	TATA handle in resin with low lever for shutter lock	IV	67
09999 <b>2133</b>	Shaped adaptation cylinder	IV	69
09999 <b>2134</b>	Oval adaptation cylinder	IV	69
09999 <b>2136</b>	Lock frame reduction from 8 mm to 6 mm	IV	69
09999 <b>2139</b>	Right - left terminal plugs for shutter profile ALL.CO - CE 024	II	20
09999 <b>2140</b>	Right - left terminal plugs for shutter profile ALL.CO - CE 003	II	20
09999 <b>2146</b>	48 mm MINI hinge with 1 mm coplanar thickness	III	40
09999 <b>2147</b>	48 mm MEDIA hinge with 1 mm coplanar thickness	III	40
09999 <b>2148</b>	48 mm coplanar MAXI hinge	III	39
09999 <b>2149</b>	6 mm coplanar thickness for MEDIA - MAXI hinges	III	40
09999 <b>2150</b>	2.5 mm coplanar thickness for MEDIA and MINI hinges	III	41
09999 <b>2152</b>	Oval adaptation cylinder (CISA locks and similar)	IV	69
09999 <b>2157</b>	Control for shutter lock in resin of TATA serieswith 6 x 82 mm frame	IV	67
09999 <b>2158</b>	Roller for angle cleat for mosquito net with sliding system	VI	112
09999 <b>2159</b>	Two spring clutch and compensator for angle cleat for symmetric mosquito net with latch system	VI	112
09999 <b>2160</b>	All-purpose angle cleat for asymmetric mosquito net, sliding system or latch with M5 x 9,5 screws (Patented)	VI	111
09999 <b>2161</b>	Right - left terminal plugs for shutter profile ALL.CO VZ 4303	II	19
09999 <b>2169</b>	MINI hinge, 180° rotation	III	41
09999 <b>2170</b>	MEDIA hinge, 180° rotation	III	41
09999 <b>2171</b>	MAXI hinge, 180° rotation	III	41
09999 <b>2173</b>	48 mm MAXI, MEDIA, MINI hinged joint for 360° rotation provided with pin	III	40
09999 <b>2174</b>	CHIOCCIOLA 2.5 mm thick, stainless steel screws and hole plugs closure	III	33
09999 <b>2175</b>	Connection for joints code 0233 - code 0236 EKIP EVOLUTION ZK 8275 / ZK 12035 - ALL.CO VZ 0643	VI	97
09999 <b>2179</b>	7,5mm shim for SUPER TOP GRILLO - SUPER MIDI GRILLO - SUPER MAXI GRILLO	I	4
09999 <b>2181</b>	Untiscrew proof boss for SUPER TOP GRILLO - SUPER MIDI GRILLO - SUPER MAXI GRILLO	I	5
09999 <b>2182</b>	CHIOCCIOLA for closure of pulling door for fixture, with minimum ledge thickness of 18 mm, with hole plugs	III	34
09999 <b>2183</b>	Checking cup for pushing door closure	III	33
09999 <b>2184</b>	Right - left terminal plugs for shutter profiles R 40 / 800577 - 800645	II	14
09999 <b>2187</b>	Right - left terminal plugs for shutter profile DOMAL SUNNY 27394 - 27539	II	18
09999 <b>2189</b>	2 mm thickness for CHIOCCIOLA	III	33
09999 <b>2190</b>	3 mm thickness for CHIOCCIOLA	III	33
09999 <b>2191</b>	Assembly Block for wood/aluminium profiles	I	9
09999 <b>2192</b>	Oval boss in resin for shaped cylinder of TATA series	IV	68
09999 <b>2198</b>	Right - left terminal plugs for shutter profile ALL.CO VZ 4366	II	19
09999 <b>2213</b>	14,5mm shim for SUPER TOP GRILLO - SUPER MIDI GRILLO - SUPER MAXI GRILLO	I	5
09999 <b>2560</b>	Right - left terminal plugs INDINVEST 40075 / 40134	II	21
09999 <b>2561</b>	Right - left terminal plugs INDINVEST 40136	II	21
09999 <b>2617</b>	Hinge for hinged mosquito net framework without spring	III	36
09999 <b>2618</b>	Hinge for hinged mosquito net frameworkwith spring and rigging pin made of zama	III	36
09999 <b>2623</b>	Pair of plugs for central rabbet rebated reverse R 40 REVAMPING half-moon	II	23
09999 <b>2709</b>	Universal flat catch small handle with 3-4-5-mmcompensation thicknesses	III	34
09999 <b>2710</b>	Universal flat catch, large handle with 3-4-5 mmcompensation thicknesses	III	35
09999 <b>2711</b>	Hinge for hinged mosquito net frameworkflat without spring	III	37
09999 <b>2712</b>	Hinge for hinged mosquito net frameworkflat with spring and rigging pin made of zama	III	37
09999 <b>2713</b>	Hinge for hinged mosquito net framework withoutspring and 11.6 mm rail	III	37
09999 <b>2714</b>	Hinge for hinged mosquito net framework with spring, rigging pin made of zama and 11.6 mm rail	III	37
09999 <b>2715</b>	Hinge for hinged mosquito net framework without spring and 13.3 mm rail	III	38
09999 <b>2716</b>	Hinge for hinged mosquito net framework with spring, 13.3 mm rail and rigging pin made of zama	III	38
09999 <b>2717</b>	Kit with 16.6 mm galvanized butterfly nut and M5 x 10 stainless steel screw	III	39
09999 <b>2718</b>	Kit with 19.5 mm galvanized butterfly nut and M5 x 10 stainless steel screw	III	39
09999 <b>2719</b>	Single match for rod for 14 mm chamber, with 16.6 mm stainless steel butterfly nut ABITHAL GREEN - DOMAL STOPPER - DOMAL BREAK - EKU 53 / 64 TT / 72 TT - EXPORT 45 / 45TT / 50 / 50 TT - GOLD 400 - K 40 - SYNTHESIS 45	III	53
09999 <b>2720</b>	Single match for rod for 14 mm chamber, with 16.6 mm galvanized butterfly nut ABITHAL GREEN - DOMAL STOPPER - DOMAL BREAK - EKU 53 / 64 TT / 72 TT - EXPORT 45 / 45TT / 50 / 50 TT - GOLD 400 - K 40 - SYNTHESIS 45	III	53



CODE	DESCRIPTION	CHA	PAG
099992721	Single match for rod for 14 mm chamber, with 19.5 mm stainless steel butterfly nut ALL.CO 5 - ALPHA 445 / 658 TT - EKIP 40 / 50 - EURO40 - new NC 40	III	53
099992722	Single match for rod for 14 mm chamber, with 19.5 mm galvanized butterfly nut ALL.CO 5 - ALPHA 445 / 658 TT - EKIP 40 / 50 - EURO40 - new NC 40	III	53
099992723	Double match for rod for 14 mm chamber, with 16.6 mm stainless steel butterfly nut ABITHAL GREEN - DOMAL STOPPER - DOMAL BREAK - EKU 53 / 64 TT / 72 TT - EXPORT 45 / 45TT / 50 / 50 TT - GOLD 400 - K 40 - SYNTHESIS 45	III	54
099992724	Double match for rod for 14 mm chamber, with 16.6 mm galvanized butterfly nut ABITHAL GREEN - DOMAL STOPPER - DOMAL BREAK - EKU 53 / 64 TT / 72 TT - EXPORT 45 / 45TT / 50 / 50 TT - GOLD 400 - K 40 - SYNTHESIS 45	III	54
099992725	Right - left match for rod for 15 mm chamber, with 19.5 mm stainless steel butterfly nut new NC 40 - SISTEMA 1	III	54
099992726	Right - left match for rod for 15 mm chamber, with 19.5 mm galvanized butterfly nut new NC 40 - SISTEMA 1	III	54
099992727	16.5 mm rod terminal with stainless steel pin NC 45 INTERNATIONAL / SUPER THERMIC - NC 55 - INTERNATIONAL NC 65 / 68 / 72 SUPER THERMIC	III	43
099992728	16.5 mm rod terminal with galvanized pin NC 45 INTERNATIONAL / SUPER THERMIC - NC 55 - INTERNATIONAL NC 65 / 68 / 72 SUPER THERMIC	III	43
099992730	18 mm rod terminal with connection bridge for cremone bolt rod and stainless galvanized pin	III	43
099992731	19.5 mm rod terminal with stainless steel pin DOMAL BREAK / GELOSIA / STOPPER PG - GOLD - ALL.CO K40 / 5TT / P4 / EXPORT - EKIP 40 - new NC 40	III	45
099992732	19.5 mm rod terminal with galvanized pin DOMAL BREAK / GELOSIA / STOPPER PG - GOLD - ALL.CO K40 / 5TT / P4 / EXPORT - EKIP 40 - new NC 40	III	45
099992733	18 mm rod terminal with connection bridge for cremone bolt rod and decentered stainless steel pin R 40 / R 50 TT / R 62 / R 72 - NEW TEC 50 / 52 / 60 / 68 ST - ESEDRA GA 53 - ESEDRA LIGHT 42 / 50 - ESEDRA TT 63 / TT 75	III	44
099992734	18 mm rod terminal with connection bridge for cremone bolt rod and decentered galvanized pin R 40 / R 50 TT / R 62 / R 72 - NEW TEC 50 / 52 / 60 / 68 ST - ESEDRA GA 53 - ESEDRA LIGHT 42 / 50 - ESEDRA TT 63 / TT 75	III	44
099992735	16.5 mm control rod with connection bridge NC 45 INTERNATIONAL / SUPER THERMIC - NC 55 INTERNATIONAL - NC 65 / 68 / 72 SUPER THERMIC	III	42
099992736	18 mm control rod with connection bridge R 40 / R 50 TT / R 62 / R 72 - NEW TEC 50 / 52 / 60 / 68 ST - ESEDRA GA 53 - ESEDRA LIGHT 42 / 50 - ESEDRA TT 63 / TT 75	III	42
099992737	19.5 mm control rod with connection bridge DOMAL BREAK / GELOSIA / STOPPER PG - GOLD - ALL.CO K40 / 5TT / P4 / EXPORT - EKIP 40 - new NC 40	III	42
099992738	16.5 mm latch with stainless steel pin NC 45 INTERNATIONAL / SUPER THERMIC - NC 55 INTERNATIONAL - NC 65 / 68 / 72 SUPER THERMIC	III	47
099992739	16.5 mm latch with galvanized pin NC 45 INTERNATIONAL / SUPER THERMIC - NC 55 INTERNATIONAL - NC 65 / 68 / 72 SUPER THERMIC	III	47
099992742	19.5 mm latch with stainless steel pin DOMAL BREAK / GELOSIA / STOPPER PG - GOLD - ALL.CO K40 / 5TT / P4 / EXPORT - EKIP 40 - new NC 40	III	50
099992743	19.5 mm latch with galvanized pin DOMAL BREAK / GELOSIA / STOPPER PG - GOLD - ALL.CO K40 / 5TT / P4 / EXPORT - EKIP 40 - new NC 40	III	50
099992744	18 mm latch with stainless steel pin and connection bridge for rod R 40 / R 50 TT / R 62 / R 72 - NEW TEC 50 / 52 / 60 / 68 ST - ESEDRA GA 53 - ESEDRA LIGHT 42 / 50 - ESEDRA TT 63 / TT 75	III	48
099992745	18 mm latch with galvanized pin and connection bridge for rod R 40 / R 50 TT / R 62 / R 72 - NEW TEC 50 / 52 / 60 / 68 ST - ESEDRA GA 53 - ESEDRA LIGHT 42 / 50 - ESEDRA TT 63 / TT 75	III	48
099992747	CRISTINA handle in BRIGHT resin with oval boss and return spring (Patented)	IV	60
099992748	CRISTINA handle in MATT resin with oval boss and return spring (Patented)	IV	60
099992749	CRISTINA handle in BRIGHT resin with round boss and return spring (Patented)	IV	61
099992750	CRISTINA handle in MATT resin with round boss and return spring (Patented)	IV	61
099992751	TATA handle in resin with return spring	IV	66
099992752	BRUCO manual part shutter for two leaf window with bronzed screws	I	7
099992753	CRISTINA handle in aluminium with oval boss and return spring (Patented)	IV	63
099992754	CRISTINA handle in aluminium with round boss and return spring (Patented)	IV	64
099992755	CRISTINA handle in MATT resin with oval boss without return spring (Patented)	IV	60
099992756	CRISTINA handle in BRIGHT resin with oval boss without return spring (Patented)	IV	60
099992757	CRISTINA handle in BRIGHT resin with round boss without return spring (Patented)	IV	62
099992758	CRISTINA handle in MATT resin with round boss without return spring (Patented)	IV	62
099992759	TATA handle in resin with grain and return spring	IV	66
099992764	Glass loader thicknesses, ANGEL, 2 mm R 40 REVAMPING - R 50 TT	VI	104
099992765	Glass loader thicknesses, ANGEL, 5 mm R 40 REVAMPING - R 50 TT	VI	104
099992766	Glass loader thicknesses, ANGEL, 5.5 mm R 40 REVAMPING - R 50 TT	VI	104
099992767	Glass loader thicknesses, ANGEL, 10.5 mm with hole R 40 REVAMPING - R 50 TT	VI	104
099992768	Oval boss in resin for PATENT key of TATA series	IV	68
099992773	Reversible saddle for fixed shutter for thread glass profile 25x24 max - 18 minimum mm camera for 50x10 ovaline	VI	89
099992774	Half reversible saddle for fixed shutter for thread glass profile 25x24 max - 18 minimum mm camera for 50x10 ovaline	VI	89

CODE	DESCRIPTION	CHA	PAG
09999 <b>2777</b>	Pair of plugs for central rabbet rebated reverse ALL.CO EXPORT 45 - 45 TT	II	24
09999 <b>2778</b>	Pair of plugs for central rabbet rebated reverse R 50 TT half-moon	II	23
09999 <b>2779</b>	Pair of plugs for central rabbet rebated reverse R 50	II	23
09999 <b>2781</b>	Hinge for hinged mosquito net framework without spring with plate for profile R40	III	36
09999 <b>2782</b>	Hinge for hinged mosquito net framework with spring and plate, with rigging pin made of zama for profile R40	III	36
09999 <b>2784</b>	100 reversibles saddles blister for genovese fixed shutter for 50x10 mm ovaline FB 12 - METRA - ALL.CO - ALCAN - ABITHAL	VI	86
09999 <b>2786</b>	Pair of plugs for central rabbet rebated reverse ALL.CO 5 overlapped part	II	24
09999 <b>2787</b>	Pair of plugs for central rabbet rebated reverse ALL.CO EXPORT 50	II	24
09999 <b>2788</b>	Pair of plugs for central rabbet rebated reverse ALL.CO EXPORT 50 TT	II	24
09999 <b>2789</b>	Double match for rod with 2 stainless steel grains EXPORT - EKU - GOLD	III	56
09999 <b>2790</b>	Double match for rod with 1 stainless steel grain SISTEMA 1 - new NC 40	III	56
09999 <b>2793</b>	Pair of plugs for central rabbet rebated reverse ALL.CO WOOD	II	24
09999 <b>2794</b>	18 mm rod terminal with connection bridge for cremone bolt rod and flat galvanized pin R 40 / R 50 TT / R 62 / R 72 - NEW TEC 50 / 52 / 60 / 68 ST - ESEDRA GA 53 - ESEDRA LIGHT 42 / 50 - ESEDRA TT 63 / TT 75	III	44
09999 <b>2795</b>	18 mm latch with flat galvanized pin and connection bridge for cremone bolt rod R 40 / R 50 TT / R 62 / R 72 - NEW TEC 50 / 52 / 60 / 68 ST - ESEDRA GA 53 - ESEDRA LIGHT 42 / 50 - ESEDRA TT 63 / TT 75	III	49
09999 <b>2797</b>	Pair of plugs for central rabbet rebated reverse new NC 40 METRA	II	25
09999 <b>2798</b>	Glass loader thicknesses, ANGEL, 5.5 mm R 40 - R 50 giunto aperto	VI	104
09999 <b>2799</b>	CHIOCCIOLA 2.5 mm thick, stainless steel screws and hole plugs for closure of pulling door	III	34
09999 <b>2800</b>	Right - left CHIOCCIOLA 2.5 mm thick, stainless steel screws and hole plugs for closure of pushing door	III	34
09999 <b>2801</b>	Alignment racket R 40 - R 50	VI	102
09999 <b>2802</b>	19.5 mm rod terminal with 20 mm stainless steel pin DOMAL BREAK / GELOSIA / STOPPER PG - GOLD - ALL.CO K40 / 5TT / P4 / EXPORT - EKIP 40 - new NC 40	III	46
09999 <b>2803</b>	Right - left terminal for 18 mm rod with connection bridge for cremone bolt rod and 20 mm stainless steel pin R 40 / R 50 TT / R 62 / R 72 - NEW TEC 50 / 52 / 60 / 68 ST - ESEDRA GA 53 - ESEDRA LIGHT 42 / 50 - ESEDRA TT 63 / TT 75	III	44
09999 <b>2804</b>	19.5 mm latch with 20 mm stainless steel pin and rod DOMAL BREAK / GELOSIA / STOPPER PG - GOLD - ALL.CO K40 / 5TT / P4 / EXPORT - EKIP 40 - nuovo new nuovo NC 40	III	50
09999 <b>2805</b>	18 mm latch with 20 mm stainless steel pin R 40 / R 50 TT / R 62 / R 72 - NEW TEC 50 / 52 / 60 / 68 ST - ESEDRA GA 53 - ESEDRA LIGHT 42 / 50 - ESEDRA TT 63 / TT 75	III	48
09999 <b>2806</b>	Pair of plugs for central rabbet rebated reverse DOMAL 40	II	25
09999 <b>2807</b>	Pair of plugs for central rabbet rebated reverse DOMAL STOPPER PG 19664-23251	II	25
09999 <b>2812</b>	Double match for rod with 2 stainless steel grains ALL.CO 5 / 5 TT - R 40 / 50 TT / R 62 / R 72 - NEW TEC 50 / 52 / 60 / 68 ST - ESEDRA GA 53 - ESEDRA LIGHT 42 / 50 - ESEDRA TT 63 / TT 75	III	55
09999 <b>2813</b>	Pair of plugs for central rabbet rebated reverse R 40 straight and storic rounded recto y redondeado histórico	II	24
09999 <b>2814</b>	Latch extension	III	51
09999 <b>2815</b>	TATA handle in resin with high lever for shutter lock	IV	67
09999 <b>2817</b>	One shutter kit DOMAL BREAK / GELOSIA / STOPPER PG - GOLD - ALL.CO K40 / 5TT / P4 / EXPORT - EKIP 40 - new NC 40	III	51
09999 <b>2818</b>	Two shutter kit DOMAL BREAK / GELOSIA / STOPPER PG - GOLD - ALL.CO K40 / 5TT / P4 / EXPORT - EKIP 40 - new NC 40	III	52
09999 <b>2822</b>	One shutter kit R 40 / R 50 TT / R 62 / R 72 - NEW TEC 50 / 52 / 60 / 68 ST - ESEDRA GA 53 - ESEDRA LIGHT 42 / 50 - ESEDRA TT 63 / TT 75	III	51
09999 <b>2828</b>	Pair of plugs for central rabbet rebated reverse R 40 dritto straight recto	II	24
09999 <b>2838</b>	Window frame clip ALFIL 45 - DOMAL BREAK 70S	I	11
09999 <b>2840</b>	Alignment bracket ETNALL ET4322 - G40/G2019 - ATLANTIS AZ 2109	VI	103
09999 <b>2842</b>	Fixed shutter kit DOMAL BREAK / GELOSIA / STOPPER PG - GOLD - ALL.CO K40 / 5TT / P4 / EXPORT - EKIP 40 - new NC 40	III	42
09999 <b>2844</b>	Drainage cap DOMAL 40 / BREAK / STOPPER - ALL.CO 5 - P4 - EXPORT 40 / 50 / 60	II	22
09999 <b>2846</b>	Alignment racket R 40	VI	102
09999 <b>2847</b>	Close alignment racket R 40	VI	102
09999 <b>2848</b>	Pair of plugs for central rabbet rebated reverse DOMAL STOPPER PG 19663	II	25
09999 <b>2849</b>	Plug ETNALL ET 4322 - G 40 / G2019 - ATLANTIS AZ 2109	II	23
09999 <b>2850</b>	Pair of plugs for central rabbet rebated reverse DOMAL BREAK PA 52	II	25
09999 <b>2851</b>	Flat 18 mm control rod R 40 / R 50 TT / R 62 / R 72 - NEW TEC 50 / 52 / 60 / 68 ST - ESEDRA GA 53 - ESEDRA LIGHT 42 / 50 - ESEDRA TT 63 / TT 75	III	43
09999 <b>2852</b>	Right - left terminal for 18 mm rod, with flat galvanized pin R 40 / R 50 TT / R 62 / R 72 - NEW TEC 50 / 52 / 60 / 68 ST - ESEDRA GA 53 - ESEDRA LIGHT 42 / 50 - ESEDRA TT 63 / TT 75	III	45
09999 <b>2853</b>	18 mm latch with flat galvanized pin R 40 / R 50 TT / R 62 / R 72 - NEW TEC 50 / 52 / 60 / 68 ST - ESEDRA GA 53 - ESEDRA LIGHT 42 / 50 - ESEDRA TT 63 / TT 75	III	49
09999 <b>2854</b>	Right - left terminal plugs ALL.CO P4 VZ 0785 / VZ 0755D	II	21

CODE	DESCRIPTION	CHA	PAG
099992858	Shaped rod for latch DOMAL 40 third leaf	III	52
099992859	Connection bridge for latch DOMAL 40 third leaf	III	53
099992860	Reversible saddle for fixed shutter for thread glass profiles 25x19.3 mm camera for 50x10 mm opaline	VI	89
099992861	Pair of cremone blocks DOMAL BREAK / GELOSIA / STOPPER PG - GOLD - ALL.CO K40 / 5TT / P4 / EXPORT - EKIP 40 - new NC 40	VI	103
099992862	Milled thickness for glass camera 20x2 mm	VI	104
099992863	Milled thickness for glass camera 20x3 mm	VI	105
099992864	Milled thickness for glass camera 20x4 mm	VI	105
099992865	Milled thickness for glass camera 20x5 mm	VI	105
099992866	Milled thickness for glass camera 20x7 mm	VI	105
099992867	Seal plug for PVC fixtures with 40x40x1.5 mm tubing	VI	112
099992870	20 reversibles saddles kit for genovese fixed shutter for 50x10 mm ovaline FB 12 - METRA - ALL.CO - ALCAN - ABITHAL	VI	86
099992872	20 reversible saddles kit for genovese fixed shutter lamella centro storico 65x10 mm	VI	92
099992874	Seal plug for PVC fixtures with 40x40x2 mm tubing	VI	113
099992879	All-purpose angle cleat for asymmetric mosquito net, sliding system or latch with M5 x 11,4 screws (Patented)	VI	111
099992886	Seal plug for PVC fixtures with 40x40x1 mm tubing	VI	112
099992888	Alignment bracket of flaps ALL.CO 5 - ALL.CO P4	VI	102
099992889	Support block of hinge plate ALL.CO WOOD	VI	103
099992893	CLAC Finger catch with in full view screws and 1-2-3-7 mm compensation thickness	III	35
099992894	CLIC Finger catch with hidden screws and 1-2-3-7 mm compensation thickness	III	35
099992895	19.5 mm rod terminal with 20 mm stainless steel pin DOMAL BREAK / GELOSIA / STOPPER PG - GOLD - ALL.CO K40 / 5TT / P4 / EXPORT - EKIP 40 - new NC 40	III	47
099992897	Mosquito net handle for sliding system or latch	VI	112
099992898	Rotating supporting whell base plate with different tichness (scacciapensieri)	I	7
099992899	Right - left terminal for 18 mm rod, with 20 mm stainless steel pin R 40 / R 50 TT / R 62 / R 72 - NEW TEC 50 / 52 / 60 / 68 ST - ESEDRA GA 53 - ESEDRA LIGHT 42 / 50 - ESEDRA TT 63 / TT 75	III	45
099992900	18 mm latch with 20 mm stainless steel pin R 40 / R 50 TT / R 62 / R 72 - NEW TEC 50 / 52 / 60 / 68 ST - ESEDRA GA 53 - ESEDRA LIGHT 42 / 50 - ESEDRA TT 63 / TT 75	III	49
099992904	19.5 mm latch with 20 mm stainless steel pin and rod	III	50
099992905	Pair of cremone blocks R 40 - NEW TEC - NEW 50 / 52 TT / 60 TT	VI	103
099992906	16.5 mm latch for hinged screen with white galvanized pin	III	47
099992907	Drainage cap for 31x6 mm slot	II	22
099992916	3 m brush holder profile for camera 25 mm	II	26
099992917	2 mm thicknesses for frame / counterframe	VI	107
099992918	3 mm thicknesses for frame / counterframe	VI	107
099992919	5 mm thicknesses for frame / counterframe	VI	107
099992920	Joint with thickness new NC - ETNALL ET43 - ATLANTIS series 40 - G40	VI	102
099992921	Roller for gasket insertion WIND STOP 45 TT / 55 TT (PONZIO)	V	78
099992924	Match for rod with 2 stainless steel grains and 2 bushings ALL.CO 5S / 5STT	III	55
099992925	19.5 mm rod terminal with Ø 8x20 stainless steel pin	III	46
099992926	Low single match for rod for 14 mm chamber, with 19.5 mm stainless steel butterfly nut Shutter KL	III	53
099992928	4 mm thicknesses for frame / counterframe	VI	107
099992931	19.5 mm rod terminal with 14 mm rectangular pin shutter KL	III	46
099992935	Right-Left open spacer for 50x10 mm opaline shutter KL	VI	94
099992936	Right - Left compensator shutter KL	VI	93
099992937	Oval boss in aluminium for oval cylinder of CRISTINA series	IV	63
099992938	Oval boss in aluminium for shaped cylinder of CRISTINA series	IV	63
099992939	Oval boss in aluminium for PATENT key of CRISTINA series	IV	63
099992940	Drainage cap (holes Ø4 - distance 48)	II	22
099992952	RENATO (Patented) right - left arm for awning in aluminium DOMAL BREAK - GELOSIA STOPPER PG - GOLD / EXPORT - EKIP 40 - ALL.CO K40 / 5TT / P4 - new NC40 - R40 / R 50TT / R 62 / R 72 - NEW TEC 50 / 52 / 60 / 68ST ESEDRA GA 53 - ESEDRA LIGHT 42/50 - ESEDRA TT 63 / TT 75	III	32
099992953	SCARABEO (Patented) lock for awning fixture in aluminium with frame overlapped part- door from 0 to 12 mm max and 4 m string	III	30
099992954	Pair of plugs for central rabbet EKU 45 17675	II	26
099992955	Right - left terminal plugs EKU 45 T.E.S. 17675	II	20

CODE	DESCRIPTION	CHA	PAG
09999 <b>2956</b>	Right - left terminal plugs EKU 45 T.E.S. 17677 / 17678 leaf	II	20
09999 <b>2957</b>	Thickness for handles of CRISTINA series with oval boss and TATA handles for rounded profiles	IV	66
09999 <b>2960</b>	NUOVA EMOZIONE handle in resin, with oval boss	IV	65
09999 <b>2961</b>	Hinge for hinged mosquito net framework without spring with 14.6 mm teeth	III	38
09999 <b>2962</b>	Hinge for hinged mosquito net framework with spring, 14.6 mm teeth and rigging pin made of zama	III	38
09999 <b>2963</b>	Kit with 16.6 mm galvanized butterfly nut and TSP M5 x 8 stainless steel screw	III	39
09999 <b>2964</b>	PEPITO (Patented) stainless steel automatic shutter lock	I	5
09999 <b>2965</b>	Painted covering kit for SCARABEO	III	31
09999 <b>2966</b>	Thickness Kit for SCARABEO black colour printed	III	31
09999 <b>2967</b>	Shutter guide	I	10
09999 <b>2968</b>	Painted thickness kit for SCARABEO	III	31
09999 <b>2969</b>	Low double match for rod for 14 mm chamber, with 19.5 mm stainless steel butterfly nut Shutter KL	III	54
09999 <b>2970</b>	Spacer from mm Ø 15x16,5 R 40 - R 50 - ALL.CO 5 - ALL.CO P4 - ALPHA 445 / 545 / 658 TT	VI	105
09999 <b>2971</b>	Spacer from mm Ø 15x34 universal	VI	106
09999 <b>2972</b>	Spacer from mm Ø 19x16.5 TRIALCO - ALL.CO 5	VI	106
09999 <b>2973</b>	Spacer from mm Ø 25x21 ESEDRA - EXPORT - ALL.CO 5	VI	106
09999 <b>2974</b>	Spacer from mm Ø 15x20.5 new NC 40 - NC 45 INTERNATIONAL - EKIP - EXPORT - DOMAL STOPPER	VI	105
09999 <b>2975</b>	Spacer from mm Ø 19x20.5	VI	106
09999 <b>2976</b>	Spacer from mm Ø 25x21 universal	VI	106
09999 <b>2977</b>	Shutter guide	I	10
09999 <b>2982</b>	Maxi boss for automatic shutter stopper	I	5
09999 <b>2984</b>	DIMA drill plate for SCARABEO assembly	III	30
09999 <b>2988</b>	Hidden arm manual part shutter	I	7
09999 <b>2989</b>	6 m string for SCARABEO	III	32
09999 <b>2991</b>	Reducer for corner joint	VI	103
09999 <b>2998</b>	SCARABEO (Patented) lock for awning fixture with frame overlapped part - door from 0 to 12 mm max. and 4 m. string	III	30
09999 <b>2999</b>	RENATO (Patented) right - left arm for awning in wood and pvc	III	32
09999 <b>3000</b>	SUPER TOP GRILLO (Patented) automatic shutter lock with 70 mm. Screw	I	2
09999 <b>3001</b>	SUPER TOP GRILLO (Patented) automatic shutter lock with 120 mm. Screw	I	2
09999 <b>3002</b>	SUPER TOP GRILLO (Patented) automatic shutter lock with shock absorber and 70 mm. Screw	I	2
09999 <b>3003</b>	SUPER TOP GRILLO (Patented) automatic shutter lock with shock absorber and 120 mm. Screw	I	2
09999 <b>3004</b>	SUPER TOP GRILLO (Patented) automatic shutter lock with extended plug and screw 70 mm	I	2
09999 <b>3005</b>	SUPER TOP GRILLO (Patented) automatic shutter lock with extended plug and screw 120 mm	I	2
09999 <b>3006</b>	SUPER TOP GRILLO (Patented) automatic shutter lock with extended plug shock absorber and screw 70 mm	I	2
09999 <b>3007</b>	SUPER TOP GRILLO (Patented) automatic shutter lock with extended plug shock absorber and screw 120 mm	I	2
09999 <b>3008</b>	SUPER MIDI GRILLO (Patented) automatic shutter lock with 70 mm screw	I	3
09999 <b>3009</b>	SUPER MIDI GRILLO (Patented) automatic shutter lock with 120 mm screw	I	3
09999 <b>3010</b>	SUPER MIDI GRILLO (Patented) automatic shutter lock with shock absorber and 70 mm screw	I	3
09999 <b>3011</b>	SUPER MIDI GRILLO (Patented) automatic shutter lock with shock absorber and 120 mm screw	I	3
09999 <b>3012</b>	SUPER MAXI GRILLO (Patented) double leaf automatic shutter lock with 70 mm screw	I	4
09999 <b>3013</b>	SUPER MAXI GRILLO (Patented) double leaf automatic shutter stopper with 120 mm screw	I	4
09999 <b>3015</b>	SUPER MAXI GRILLO (Patented) double leaf automatic shutter lock with shock absorber and 70 mm screw	I	4
09999 <b>3016</b>	SUPER MAXI GRILLO (Patented) double leaf automatic shutter lock with shock absorber and 120 mm screw	I	4
09999 <b>3018</b>	SUPER TOP GRILLO (Patented) automatic shutter lock with maxi regulation plug and screw 70 mm	I	3
09999 <b>3019</b>	SUPER TOP GRILLO (Patented) automatic shutter lock with maxi regulation plug shock absorber and 70 mm screw	I	3
09999 <b>3020</b>	SUPER MIDI GRILLO (Patented) automatic shutter lock with shock absorber and 150 mm screw	I	3
09999 <b>3021</b>	Bracket adapter for perimeter frame	III	56
09999 <b>3022</b>	Shutter spacer s/ traditional 17,3 x7,3 mm	III	56
09999 <b>3023</b>	Shutter spacer 23,3 x14 mm	III	57
09999 <b>3024</b>	Shutter spacer 23,3 x11 mm	III	57
09999 <b>3027</b>	18 mm latch with stainless galvanized pin and connection bridge for rod	III	48
09999 <b>3028</b>	Covering kit for SCARABEO black colour printed	III	31
09999 <b>3034</b>	Bent spanner for rotation of assembly block (cod 1638) wood /aluminium profiles	V	81

CODE	DESCRIPTION	CHA	PAG
09999 <b>3035</b>	SUPER TOP GRILLO (Patented) automatic shutter lock with 150 mm. Screw	I	2
09999 <b>3036</b>	SUPER TOP GRILLO (Patented) automatic shutter lock with shock absorber and 150 mm. Screw	I	2
09999 <b>3037</b>	SUPER MAXI GRILLO (Patented) double leaf automatic shutter lock with 150 mm screw	I	4
09999 <b>3039</b>	Pair of extended cremone blocks	VI	103
09999 <b>3042</b>	Shutter spacer 27,7 x 10,2 mm	III	57
09999 <b>3047</b>	Reversible saddle for fixed shutter for profiles mm 36x17 mm 50x10 ovaliner	VI	88
09999 <b>3048</b>	Right - left compensator for fixed shutter for profiles mm 36x17 mm 50x10 ovaliner	VI	88
09999 <b>3049</b>	Bracket adapter for open frame 9,8 x 10 mm	III	57
09999 <b>3050</b>	Bracket adapter for open frame 7x12 mm	III	57
29999 <b>0825</b>	Handle for roller for gas insertion with two arms	V	79
29999 <b>0827</b>	Handle for roller for gas insertion with one arm	V	79
31000 <b>8800</b>	AVP $\varnothing$ 8 rod	IV	71
69999 <b>0129</b>	Small half-round plug	VII	119
69999 <b>0149</b>	Pair of hooks for curtain	VII	119
69999 <b>0150</b>	Striker ledge	VII	124
69999 <b>0155</b>	Guide block 40x18	VII	117
69999 <b>0156</b>	Release striker GR 9	VII	116
69999 <b>0157</b>	Angle cover GR 9	VII	116
69999 <b>0158</b>	Angle cover NC 40-50	VII	116
69999 <b>0159</b>	Plug 20x10	VII	120
69999 <b>0160</b>	Coverhole plug $\varnothing$ 12	VII	117
69999 <b>0161</b>	Coverhole plug $\varnothing$ 14	VII	117
69999 <b>0163</b>	Plug 50x50	VII	122
69999 <b>0164</b>	Plug 25x25	VII	120
69999 <b>0165</b>	Plug 30x30	VII	121
69999 <b>0166</b>	Plug 20x20	VII	120
69999 <b>0167</b>	Handrail plugs	VII	118
69999 <b>0168</b>	Plug 40x20	VII	121
69999 <b>0169</b>	Release striker NC	VII	116
69999 <b>0172</b>	Guide block 50x25	VII	117
69999 <b>0173</b>	Hinge washer internal diameter mm. 11	VII	118
69999 <b>0174</b>	Plug 20x80	VII	120
69999 <b>0175</b>	Plug 40x60	VII	121
69999 <b>0176</b>	Universal striker	VII	116
69999 <b>0177</b>	Small trapezoidal plug	VII	119
69999 <b>0178</b>	Ledge cover GR 9	VII	116
69999 <b>0179</b>	Ledge cover NC 40-50	VII	117
69999 <b>0180</b>	Plug 30x20	VII	121
69999 <b>0182</b>	Plug 30x60	VII	121
69999 <b>0183</b>	Plug 15x30	VII	119
69999 <b>0184</b>	Plug 20x100	VII	120
69999 <b>0185</b>	Guide block 40 x19 GR 9	VII	117
69999 <b>0187</b>	Big trapezoidal plug	VII	119
69999 <b>0188</b>	Plug 40x40	VII	121
69999 <b>0189</b>	Striker bushing $\varnothing$ 6	VII	118
69999 <b>0190</b>	Plug 40x80	VII	122
69999 <b>0349</b>	LÖWE metal scissors	VII	124
69999 <b>0634</b>	Plug 15x80	VII	119
69999 <b>0824</b>	Plug 25x50	VII	120
69999 <b>0950</b>	Frame corner joint for insect roller screen with up and down track system	VII	123
69999 <b>0954</b>	Compensator insert for insect roller screen with up and down track system	VII	123
69999 <b>0967</b>	Dust cover cylinder $\varnothing$ 6	VII	124
69999 <b>0968</b>	Dust cover cylinder $\varnothing$ 8	VII	124



# ÍNDICE ANALÍTICO



CÓDIGO	DESCRIPCIÓN	CAP	PAG
00637 <b>2890</b>	Soporte reversible persiana fija lamella centro histórico Firenze mm 65x9 ALL.CO camera mm 14x35	VI	93
01032 <b>2890</b>	Soporte reversible persiana fija lamella centro histórico Firenze mm 65x10 DEMAL camera mm 14x35	VI	92
09999 <b>0005</b>	CICALONE cierra ventana abisagrada 1 hoja	I	7
09999 <b>0006</b>	MINI GRILLO retenedor de hoja automático para 3ª hoja	I	6
09999 <b>0007</b>	CALABRONE retenedor de hoja manual con tornillo de 70mm	I	6
09999 <b>0009</b>	FARFALLA retenedor de hoja manual con tornillo de 70mm.	I	6
09999 <b>0010</b>	Distancia dor abierto Dch-Izd 39 mm con borde y espesor para lama ovalina 50x10 mm	VI	95
09999 <b>0012</b>	Pasa cinta UNIBLOCK con placa y tornillos	I	7
09999 <b>0013</b>	Guía eje 40-50	I	8
09999 <b>0014</b>	Tapa vierteaguas	II	21
09999 <b>0017</b>	Tapón terminal para perfiles persiana NC 40	II	16
09999 <b>0018</b>	Tapones terminal derecha - izquierda para perfil persiana METRA - R 3553	II	15
09999 <b>0019</b>	Distanciador cerrado Dch-Izd 45,5 mm para lama ovalina 50x10 mm	VI	94
09999 <b>0020</b>	Tapón terminal para perfiles persiana NC 40 sobredimensionado	II	16
09999 <b>0022</b>	Distanciador abierto Dch-Izd 40 mm para lama ovalina 50x10 mm	VI	94
09999 <b>0023</b>	Tapón terminal para perfiles persiana R 40 / 900396 - ALL.CO / 1494	II	14
09999 <b>0024</b>	Tapón terminal para perfil persiana cámara Naco EKIP 40 / 10211 sobredimensionado - NC 40 sobredimensionado	II	15
09999 <b>0025</b>	Distanciador abierto Dch-Izd 39 mm con espesor para lama ovalina 50x10 mm	VI	94
09999 <b>0026</b>	Tapón terminal para perfiles persiana R 40 / 900399 - ALL.CO 5	II	14
09999 <b>0027</b>	Soporte reversible (1º tipo) persiana fija tipo genovés para lama ovalina 50x10 mm FB 12 - METRA - ALL.CO - ALCAN - ABITHAL etc.	VI	86
09999 <b>0028</b>	Ruleta inserción junta central para unión abierta universal	V	78
09999 <b>0029</b>	Soporte reversible persiana fija tipo genovés para lama ovalina 60x10 mm FB 12 - METRA - ALL.CO - ALCAN - ABITHAL	VI	90
09999 <b>0030</b>	Tapón terminal para perfiles persiana ALPHA 445 - ALL.CO 1488/1569	II	16
09999 <b>0032</b>	Sistema de bloqueo para eje de Ø 6 para persiana	I	8
09999 <b>0033</b>	Tapón para ovalina 10x50	II	16
09999 <b>0040</b>	Tirador trefilado pequeño en aluminio de 160 mm con escudo redondo	IV	71
09999 <b>0041</b>	Tirador trefilado pequeño en aluminio de 270 mm con escudo redondo	IV	72
09999 <b>0042</b>	Distanciador abierto Dch-Izd 39 mm con espesor para lama ovalina 50x10 mm	VI	94
09999 <b>0043</b>	Tirador perfilado grande en aluminio de 320 mm con escudo redondo	IV	72
09999 <b>0044</b>	Tirador trefilado pequeño en aluminio de 160 mm con escudo oval	IV	71
09999 <b>0045</b>	Tirador trefilado pequeño en aluminio de 270 mm con escudo oval	IV	71
09999 <b>0046</b>	Tirador perfilado grande en aluminio de 320 mm con escudo oval	IV	72
09999 <b>0049</b>	Pomo PEGASO en aluminio con escudo redondo	IV	70
09999 <b>0052</b>	Contraplaca NC - GR 9	I	10
09999 <b>0054</b>	Tapón terminal dch-izd para perfiles persiana genovesas FB 12 - METRA - ALL.CO	II	14
09999 <b>0056</b>	Pala pequeña paramontaje cristales	V	80
09999 <b>0057</b>	Pala grande paramontaje cristales	V	80
09999 <b>0058</b>	Soporte reversible persiana fija para lama ovalina 50x10 mm R 40 - ALPHA 455	VI	88
09999 <b>0059</b>	Soporte reversible persiana fija para lama ovalina 50x10 mm ALL.CO 1494 / 1549	VI	87
09999 <b>0060</b>	Corta embalajes y inserción junta acristalar	V	80
09999 <b>0061</b>	Soporte reversible persiana fija tipo genovés para lama ovalina 50x10 mm FB 12 - METRA - ALL.CO - ALCAN - ABITHAL	VI	86
09999 <b>0063</b>	Tapón terminal para perfiles persiana FB 12 - METRA - ALL.CO - GLOBAL	II	15
09999 <b>0068</b>	Tope regulable para persiana mallorquina	I	8
09999 <b>0069</b>	Soporte reversible persiana fija para lama ovalina 50x10 mm EKIP 40 - METRA - GR 9 - NC - ALL.CO SPRINT P 4 - EURO 40 - SYNTHESIS - SISTEMA 1 - ALU ■ K 494 - ALL.CO 1494/1549	VI	87
09999 <b>0072</b>	Soporte reversible persiana fija para lama ovalina 50x10 mm DOMAL GELOSIA - DOMAL 40 - DOMAL STOPPER PG - ALL.CO 5/1556	VI	87
09999 <b>0078</b>	Distanciador abierto Dch-Izd 39 mm con borde y espesor para lama ovalina 50x10 mm	VI	94
09999 <b>0080</b>	Pomo PEGASO en aluminio con escudo oval	IV	70
09999 <b>0081</b>	Escudo oval para bombín oval	IV	68
09999 <b>0082</b>	Escudo fino para bombín moldeado	IV	68
09999 <b>0094</b>	Escudo oval para bombín moldeado	IV	68

CÓDIGO	DESCRIPCIÓN	CAP	PAG
099990095	Cerradero ajustable para varilla Ø 6	III	55
099990096	Escudo fino para bombín oval	IV	68
099990098	Boca para terminal de Ø 6	I	8
099990099	LIBELLULA retenedor de hoja manual con tornillo de 70mm	I	6
099990100	Unión angular paraintradós de aluminio	VI	107
099990102	Distanciador abierto Dch-Izd 49 mm con borde y espesor para lama ovalina 65x10 mm	VI	95
099990103	Distanciador abierto Dch-Izd 49 mm con borde y espesor para lama ovalina 65x10 mm	VI	95
099990104	SopORTE reversible persiana fija tipo genovés para lama ovalina 65x10 mm FB 12 - METRA - ALL.CO - ALCAN - ABITHAL	VI	91
099990105	Ruleta inserción junta central R 40 / 50 - GLOBAL - ALL.CO 5 superposición	V	76
099990106	Ruleta inserción junta central para precámara hoja R 40 / 50 rígida	V	76
099990107	Ruleta inserción junta central EKIP 50	V	77
099990108	Ruleta inserción junta central EKIP 40	V	77
099990109	Ruleta inserción junta central DECORA - SISTEMA 1 - SISTEMA 2 WOOD (PROFILATI s.p.a. T.E.S.)	V	78
099990110	Ruleta inserción junta central nuevo - NC 40	V	77
099990111	Ruleta inserción junta mosquitera	V	76
099990112	Ruleta inserción junta central ALL.CO 5 coplanar	V	76
099990113	Ruleta inserción junta central ALPHA 255 / 445 - BLITZ	V	76
099990114	Ruleta inserción junta central NC 45 SUPERTHERMIC - NC 45 INTERNATIONAL	V	77
099990116	Ruleta inserción junta central DOMAL STOPPER - SYNTHESIS	V	77
099990122	Unión DOMAL STOPPER PG	VI	96
099990123	Tapón terminal para perfiles persiana EKIP 40 / 8146 - METRA	II	15
099990127	Clip junquillo serie ALPHA 445 - GLOBO	I	11
099990194	Tapones terminal dch-izd para perfil persiana ALL.CO VZ 3466	II	22
099990195	Tapón perfil pasamano ALL.CO VZ 1255	II	23
099990196	SopORTE reversible persiana fija tipo genovés para lama tipo centro histórico 65x10 mm	VI	92
099990233	Unión para perfiles persiana ALL.CO 5 1144 / 3184 / 1549 / 3184 - EKIP 40 - EKIP EVOLUTION - ZK 10211 / ZK 8275 / ZK 12035	VI	97
099990234	Unión para perfil persiana METRA - NC 40	VI	98
099990235	Unión para perfiles persiana banda baja DOMAL GELOSIA - DOMAL GELOSIA 40	VI	96
099990236	Unión para perfiles persiana GR 9 - NC 40 - METRA - SYNTHESIS - ALL.CO VZ 4274 / VZ 0643 - DOMAL	VI	97
099990237	Unión para perfil persiana	VI	99
099990238	Unión con acoplamiento ALLIANCE para perfiles persiana ALPHA 445 - R 40 900396 / 900619 900399 / 900261 / 900409	VI	97
099990279	Unión para perfiles persiana ALL.CO 1494 / 3184 - METRA 3134 / 3138	VI	98
099990282	Unión para perfiles persiana METRA FIRENZE 4113 / 4026	VI	99
099990288	Palanca para montaje y desmontaje clips serie ALPHA 445 - GLOBO	V	80
099990290	Clip tapajuntas EXPORT 50 - TRIALL.CO	I	11
099990294	Unión para perfil persiana FB 12	VI	100
099990295	COCCINELLA cierre para postigos, cajones, tablonés, etc.con espesores de 1 - 1,2 - 2 - 3 mm	III	32
099990678	Cubre ángulo ALPHA 255	II	23
099990680	Unión para perfiles persiana banda alta DOMAL GELOSIA - DOMAL GELOSIA 40	VI	96
099990681	Ruleta inserción junta central NEW TEC	V	78
099990685	Pasa cinta UNIBLOCK extendida EKIP - DOMAL - ALL.CO - R 40 - OCMA - EURO	I	10
099990694	Unión para perfiles persiana: DOMAL UNIVERSAL 55 21662 / 21663 - 21675	VI	96
099990695	Tapones terminal dch-izd para perfil persiana DOMAL UNIVERSAL 55 / 21662	II	17
099990698	SopORTE reversible persiana fija per lamella NACO SP 54 R 40 - R 40 histórico - ALPHA 445	VI	89
099990699	Tapones terminal dch-izd para perfil persiana DOMAL GELOSIA / 24457	II	17
099990814	Kit escudo redondo pomo PEGASO para montante	IV	70
099990815	Kit escudo oval pomo PEGASO para montante	IV	70
099990860	Tapones terminal dch-izd para perfil persiana DOMAL GELOSIA / 19663	II	17
099990861	Tapón terminal dch-izd para perfil persiana movimiento DOMAL R 40 - ALL.CO - ALPHA 445 - EKIP 40	II	17
099990897	Retenedor sobredimensionado para SUPER TOP GRILLO - SUPER MIDI GRILLO - SUPER MAXI GRILLO	I	4
099990914	Arandela diámetro interno 12 mm	III	39
099991100	Unión angular para contramarco en chapa cincada, con extensiones de 60 mm (longitud total 138 mm)	VI	108
099991101	Extensiones 30 mm unión angular para contramarco en chapa cincada	VI	108
099991102	Extensiones 20 mm unión angular para contramarco en chapa cincada	VI	108



CÓDIGO	DESCRIPCIÓN	CAP	PAG
099991103	Ruleta inserción junta central ALL.CO WOOD - ALL.CO EXPORT 50 / 50 T.T. - EKU 53 - ALL.CO 45/45 TT - ALFIL A45/A45 RPT - ETA	V	76
099991104	Ruleta inserción junta central serie ALULEN THERMIC	V	78
099991110	Clip junquillo serie SISTEMA 1 TRAFILERIE EMILIANE	I	11
099991116	Soporte reversible persiana fija para lama ovalina 50x10 mm DOMAL 21662 - DOMAL 40 / 19741 - GR 9 - R40 - ALPHA 445 - NEW TEC PQ 4875	VI	87
099991121	Unión DOMAL BREAK PA 52 15109 / 15120	VI	97
099991122	Unión DOMAL 40 19658 / 26174	VI	96
099991123	Tapones terminal dch-izd EQUIPE INVERSIONE	II	18
099991124	Tapones terminal dch-izd para perfil persiana ante persiana rustica EQUIPE	II	18
099991125	Tapones terminal dch-izd para perfil persiana ante persiana EQUIPE 8000	II	18
099991126	Unión METRA - NC 45 INTERNATIONAL 3462 / 3654 / 3463	VI	99
099991127	Unión R 40 800327 / 800325 - 800326 / 800331	VI	100
099991128	Llave para rotación bloque de ensamblaje (cód. 1638) perfiles madera / aluminio	V	80
099991413	Unión ALL.CO 5 1520 / 5091 / 5092	VI	98
099991414	Unión para perfiles persiana ALL.CO 5 VZ 3608 / VZ 3609	VI	98
099991415	Tapones terminal dch-izd para perfil persiana EKLI - ALL.CO 5 VZ 3608	II	19
099991426	Espesor para uniones art. 0122 - 1122	VI	96
099991429	Tapones terminaldch-izd para perfil persiana movimiento METALTECNICA	II	21
099991430	Unión para perfil persiana movimiento METALTECNICA	VI	100
099991432	Unión para perfiles persiana INDINVEST serie GOLD 400 40073 / 40072	VI	101
099991433	Unión para perfiles persiana INDINVEST serie GOLD 400 40109 / 40110	VI	101
099991434	Tapones terminal dch-izd INDINVEST serie GOLD 400 / 40109 40073 - 40074	II	21
099991533	Soporte reversible persiana fija para lama ovalina 65x10 mm EKIP 40 - METRA - GR 9 - NC - ALL.CO SPRINT P 4 - EURO 40 - SYNTHESIS - SISTEMA 1 - ALU ■ K 494	VI	91
099991535	Espesor 15 mm para medio soporteArt. 1116 - 0058	VI	93
099991562	Bloqueo de ensamblaje para perfiles madera / aluminio (usar llave cod. 2896)	I	9
099991638	Bloqueo de ensamblaje para perfiles madera / aluminio (usar llave cod.1128)	I	9
099991670	Unión para perfiles persiana METRA nuevo NC 40 3382 / 4359	VI	99
099991738	Ruleta inserción junta central EKIP EVOLUTION	V	77
099991741	Ruleta inserción junta central ABITHAL GREEN - ABITHAL KEEPER 53/60 - ABITHAL KEEPER 60/68	V	79
099991800	Espesor angular para cristal inserción	VI	108
099991804	Unión ALL.CO - EXPORT 50 - 5097 / 5096	VI	98
099991805	Unión DOMAL INDOOR 27503 / 27504	VI	95
099991806	Unión para perfil persiana FB 12 ocultable	VI	100
099991807	Unión para perfil persiana RIVIERA	VI	100
099991808	Soporte reversible persiana fija para perfiles cámara 14x35 mm lamella UNIVERSAL 55	VI	90
099991818	Distanciador abierto Dch-lzd 60 mm con borde y espesor lamella Kosmica mm 72,5 camera METALTECNICA	VI	95
099991824	Soporte reversible persiana fija para lama ovalina 65x10 mm R40 - ALPHA 445 - DOMAL 21662 - DOMAL 40/19741 - GR 9 NEW - TEC PQ 4875	VI	91
099991826	Soporte reversible persiana fija para lama ovalina 65x10 mm DOMAL GELOSIA - DOMAL 40 - DOMAL STOPPER PG - ALL.CO 5 / 1556	VI	91
099991829	Unión para perfil persiana tipo genovés METRA 3295	VI	99
099991830	Unión para perfil persiana tipo genovés METRA 3291	VI	99
099991837	Registro con tornillo de 10 mm	VI	109
099991841	Registro con tornillo de 18 mm	VI	109
099991863	Kit espesor angular para cristal inserción con tornillo de registro de 10 mm	VI	108
099991864	Kit espesor angular para cristal inserción con tornillo de registro de 18 mm	VI	109
099991881	Escudo oval en resina MATE para bombín moldeado serie CRISTINA	IV	61
099991882	Escudo redondo en resina MATE para bombín moldeado serie CRISTINA	IV	62
099991884	Escudo redondo en resina MATE para llave PATENT serie CRISTINA	IV	62
099991896	Unión para perfiles persiana DOMAL UNIVERSAL 55 21662 / 21663 - 21675	VI	97
099991897	Tapones terminal dch-izd para perfil persiana EKLI - ALL.CO P4 VZ 0747	II	19
099991898	Tapones terminal dch-izd para perfil persiana UNIVERSAL 55 - DOMAL GELOSIA 26211/26212 19724/19741	II	17
099991899	Tapones terminal dch-izd para perfil persiana UNIVERSAL 55 - DOMAL 40 / 21688	II	17
099991900	Soporte reversible persiana fija para lama ovalina 50x10 mm ALL.CO 5 VZ 3608 - ALL.CO P4 VZ 0747 / VZ 0739 - GOLD 400 / 40109	VI	88
099991901	Unión para perfiles persiana ALL.CO P4 VZ 0747 / VZ 0748 - ALL.CO K40 - CE 024 / VZ 0748	VI	98
099991902	Escudo redondo en resina MATE para bombín oval serie CRISTINA	IV	62
099991903	Escudo oval en resina MATE para bombín oval serie CRISTINA	IV	61

CÓDIGO	DESCRIPCIÓN	CAP	PAG
099991905	Unión para perfiles persiana ECU 53 T.E.S. 5680 / 5681	VI	101
099991906	Tapones terminal dch-izd para perfil persiana ECU 53 T.E.S. 5680	II	20
099991907	Tapones terminal dch-izd para perfil persiana ECU 53 T.E.S. 4263	II	20
099991908	Escudo oval en resina BRILLANTE para bombín moldeado serie CRISTINA	IV	61
099991909	Escudo redondo en resina BRILLANTE para bombín moldeado serie CRISTINA	IV	62
099991910	Escudo redondo en resina BRILLANTE para llave PATENT serie CRISTINA	IV	62
099991911	Escudo redondo en resina BRILLANTE para bombín oval serie CRISTINA	IV	62
099991912	Escudo oval en resina BRILLANTE para bombín oval serie CRISTINA	IV	61
099991962	Unión para perfiles persiana GLOBAL AS 4580 / 4517	VI	101
099991963	Unión para perfiles persiana R 40 900621 / 800365 - REVAMPING	VI	101
099991964	Tapones terminal dch-izd para perfil persiana R 40 / 800365	II	11
099991965	Tapones terminal dch-izd para perfil persiana R 40 / 900250 - 900658	II	14
099991966	Tapones terminal dch-izd para perfil persiana EKIP ZK 13737 / 38	II	15
099991980	Soporte reversible persiana fija para perfiles cámara mm 14x35 lamella centro histórico Firenze	VI	93
099991981	Palanca para montaje y desmontaje clips serie GOLD INDINVEST	V	80
099991990	Ruleta inserción junta central Z 106-111-113	V	79
099991999	Tapones terminal dch-izd para perfil persiana EKIP ZK 13739 / 40	II	15
099992021	Martellina CRISTINA en aluminio $\nabla$ 7	IV	65
099992050	Ruleta inserción junta central GOLD 490	V	79
099992051	Soporte reversible persiana fija para perfiles cámara 14x35 mm lamella PERLA 70	VI	92
099992052	Unión para perfiles persiana GOLD 400 40136 / 40138 / 40075 / 40076	VI	100
099992057	Ruleta inserción junta central ALU-K serie 45 CO	V	79
099992058	Guía de persiana dch-izd DOMAL SPIDER L 48/31145	I	10
099992060	Empalme 30x30 de dos vías	VI	113
099992061	Empalme 30x30 de tres vías	VI	113
099992062	Empalme 30x30 de cuatro vías	VI	113
099992063	Empalme 30x30 de cinco vías	VI	101
099992065	Unión ECU 53 T.E.S. 4264 / 4276 - 4277 / 4278	VI	101
099992066	Unión INDINVEST serie GOLD 400-500 40107 / 50049 - 40171 / 40172	VI	102
099992067	Tapones terminal dch-izd para perfil persiana EKIP ZK 11286	II	16
099992068	Tapones terminal dch-izd para perfil persiana EKIP ZK 11645	II	16
099992080	Soporte reversible persiana fija para perfiles cámara 12,5x36 mm lamella UNIVERSAL 55	VI	90
099992090	Soporte reversible persiana fija para perfiles cámara 12,5x36 mm lamella NACO SP 54	VI	90
099992091	Escudo redondo en aluminio para bombín oval serie CRISTINA	IV	64
099992092	Escudo redondo en aluminio para bombín moldeado serie CRISTINA	IV	64
099992093	Escudo redondo en aluminio para llave PATENT serie CRISTINA	IV	64
099992098	Manilla TATA en resina rebajada con muellede recuperación	IV	66
099992099	Llave para tornillo con cabeza hueca hexagonal 2 mm	V	81
099992102	Llave para tornillo con cabeza hueca hexagonal 4 mm	V	81
099992103	Llave para tornillo con cabeza hueca hexagonal 5 mm	V	81
099992104	Llave para tornillo con cabeza hueca hexagonal 6 mm	V	82
099992105	Llave para tornillo con cabeza hueca hexagonal 2,5 mm	V	81
099992106	Llave para tornillo con cabeza hueca hexagonal 3 mm	V	81
099992110	Tapones terminal dch-izd para perfil persiana DOMAL 27359	II	18
099992111	Tapones terminal dch-izd para perfil persiana DOMAL 27362	II	18
099992113	Tapones terminal dch-izd para perfil persiana ALL.CO 5 VZ 1481 / VZ 3606	II	19
099992114	Tapones terminal dch-izd para perfil persiana ALL.CO P4 VZ 0635 / VZ 0749	II	19
099992119	Manilla TATA en resina descentrada	IV	67
099992120	Cierre libre-ocupado con cuadradillo 6x82 mm	IV	69
099992123	Tapones terminal dch-izd para perfil persiana EKIP 40 ZK 10211 / ZK 9452	II	16
099992124	Unión para persiana DOMAL 26212 / 19735 / 26205 - ALUMEC - SISTEMA 1 4092 / 4037 / 4093	VI	95
099992125	Escudo fino para llave Patent	IV	69
099992127	Ruleta inserción junta central nueva serie ALULEN	V	78
099992128	BREZZA Cierre manual para ventanas abatibles conhoja sobresaliente (plantilla de perforación cód. 2143)	III	35

CÓDIGO	DESCRIPCIÓN	CAP	PAG
099992129	Juego de llaves para tornillo con cabeza hueca hexagonal	V	82
099992132	Manilla TATA en resina con maneta baja para cierre persiana	IV	67
099992133	Bombín de adaptación moldeado	IV	69
099992134	Bombín de adaptación oval	IV	69
099992136	Reducción cuadradillo cerradura de 8 a 6 mm	IV	69
099992139	Tapones terminal dch-izd para perfil persiana ALL.CO - CE 024	II	20
099992140	Tapones terminal dch-izd para perfil persiana ALL.CO - CE 003	II	20
099992146	Bisagra MINI 48 mm con espesor coplanar de 1 mm	III	40
099992147	Bisagra MEDIA 48 mm con espesor coplanar de 1 mm	III	40
099992148	Bisagra MAXI 48 mm coplanar	III	39
099992149	Espesor coplanar de 6 mm para bisagras MEDIA y MAXI	III	40
099992150	Espesor coplanar de 2,5 mm para bisagras MEDIA y MINI	III	41
099992152	Bombín de adaptación oval (cerraduras CISA y similares)	IV	69
099992157	Mando cierre persiana serie TATA en resina con cuadradillo 6x82 mm	IV	67
099992158	Rueda para escuadra mosquitera sistema corredera horizontal	VI	112
099992159	Fricción de dos muelles y compensador para escuadra mosquitera asimétrico sistema corredera vertical	VI	112
099992160	Escuadra polivalente para mosquitera asimétrico, corredera horizontal o vertical, con mosquitera M5 x 9,5 (Patentada)	VI	111
099992161	Tapones terminal dch-izd para perfil persiana ALL.CO VZ 4303	II	19
099992169	Bisagra MINI rotación 180°	III	41
099992170	Bisagra MEDIA rotación 180°	III	41
099992171	Bisagra MAXI rotación 180°	III	41
099992173	Articulación con pernio para bisagra MAXI, MEDIA, MINI de 48 mm para rotación a 360°	III	40
099992174	CHIOCCIOLA cierre de presión con espesor de 2,5 mm, tornillos acero inoxidable y tapones	III	33
099992175	Acoplamiento para uniones cód. 0233 - cód. 0236 EKIP EVOLUTION ZK 8275 / ZK 12035 - ALL.CO VZ 0643	VI	97
099992179	Espesor 7,5 mm para SUPER TOP GRILLO - SUPER MIDI GRILLO - SUPER MAXI GRILLO	I	4
099992181	Bloqueo fijación para SUPER TOP GRILLO - SUPER MIDI GRILLO - SUPER MAXI GRILLO	I	5
099992182	CHIOCCIOLA cierre de presión para cerramientos con espesor tope mínimo de 18 mm y tapones	III	34
099992183	Cerradero para cierres de presión	III	33
099992184	Tapón terminal dch-izd para perfil persiana R 40 / 800577 - 800645	II	14
099992187	Tapones terminal dch-izd para perfil persiana DOMAL SUNNY 27394 - 27539	II	18
099992189	Espesor de 2 mm para CHIOCCIOLA	III	33
099992190	Espesor de 3 mm para CHIOCCIOLA	III	33
099992191	Bloqueo de ensamblaje para perfiles madera / aluminio ALL.CO - WOOD	I	9
099992192	Escudo oval en resina para bombín moldeado serie TATA	IV	68
099992198	Tapones terminal dch-izd para perfil persiana ALL.CO VZ 4366	II	19
099992213	Espesor 14,5 mm para SUPER TOP GRILLO - SUPER MIDI GRILLO - SUPER MAXI GRILLO	I	5
099992560	Tapones terminal dch-izd INDINVEST 40075 / 40134	II	21
099992561	Tapones terminal dch-izd INDINVEST 40136	II	21
099992617	Bisagra para mosquitera practicable sin muelle	III	36
099992618	Bisagra para mosquitera practicable con muelle y eje regulable en zamak	III	36
099992623	Juego tapón inversor R 40 REVAMPING media luna	II	23
099992709	Cierre de presión universal maneta pequeña conespesores de compensación de 3-4-5 mm	III	34
099992710	Cierre de presión universal maneta grande conespesores de compensación de 3-4-5 mm	III	35
099992711	Bisagra para mosquitera practicable plana sin muelle	III	37
099992712	Bisagra para mosquitera practicable plana con muelle y eje regulable en zamak	III	37
099992713	Bisagra para mosquitera practicable sin muelle con guía de 11,6 mm	III	37
099992714	Bisagra para mosquitera practicable con muelle, eje regulable en zamak y guía de 11,6 mm	III	37
099992715	Bisagra para mosquitera practicable sin muelle con guía de 13,3 mm	III	38
099992716	Bisagra para mosquitera practicable con muelle, guía de 13,3 mm y eje regulable en zamak	III	38
099992717	Kit excéntrica cincada de 16,6 mm y tornillo inox M5 x 10	III	39
099992718	Kit excéntrica cincada de 19,5 mm y tornillo inox M5 x 10	III	39
099992719	Encuentro simple varilla para cámara de 14 mm con tuerca de mariposa inox de 16,6 mm ABITHAL GREEN - DOMAL STOPPER - DOMAL BREAK - EKU 53 / 64 TT / 72 TT - EXPORT 45 / 45TT / 50 / 50 TT - GOLD 400 - K 40 - SYNTHESIS 45	III	53
099992720	Encuentro simple varilla para cámara de 14 mm con tuerca de mariposa cincado de 16,6 mm ABITHAL GREEN - DOMAL STOPPER - DOMAL BREAK - EKU 53 / 64 TT / 72 TT - EXPORT 45 / 45TT / 50 / 50 TT - GOLD 400 - K 40 - SYNTHESIS 45	III	53

CÓDIGO	DESCRIPCIÓN	CAP	PAG
09999 <b>2721</b>	Encuentro simple varilla para cámara de 14 mm con tuerca de mariposa inox de 19,5 mm ALL.CO 5 - ALPHA 445 / 658 TT - EKIP 40 / 50 - EURO40 - nuevo NC 40	III	53
09999 <b>2722</b>	Encuentro simple varilla para cámara de 14 mm con tuerca de mariposa cincado de 19,5 mm ALL.CO 5 - ALPHA 445 / 658 TT - EKIP 40 / 50 - EURO40 - nuevo NC 40	III	53
09999 <b>2723</b>	Encuentro doble varilla para cámara de 14 mm con tuerca de mariposa inox de 16,6 mm ABITHAL GREEN - DOMAL STOPPER - DOMAL BREAK - EKU 53 / 64 TT / 72 TT - EXPORT 45 / 45TT / 50 / 50 TT - GOLD 400 - K 40 - SYNTHESIS 45	III	54
09999 <b>2724</b>	Encuentro doble varilla para cámara de 14 mm con tuerca de mariposa cincado de 16,6 mm ABITHAL GREEN - DOMAL STOPPER - DOMAL BREAK - EKU 53 / 64 TT / 72 TT - EXPORT 45 / 45TT / 50 / 50 TT - GOLD 400 - K 40 - SYNTHESIS 45	III	54
09999 <b>2725</b>	Encuentro dch - izd varilla para cámara de 15 mm con tuerca de mariposa inox de 19,5 mm nuevo NC 40 - SISTEMA 1	III	54
09999 <b>2726</b>	Encuentro dch - izd varilla para cámara de 15 mm con tuerca de mariposa cincada de 19,5 mm nuevo NC 40 - SISTEMA 1	III	54
09999 <b>2727</b>	Terminal de 16,5 mm con puntal inox NC 45 INTERNATIONAL / SUPER THERMIC - NC 55 - INTERNATIONAL NC 65 / 68 / 72 SUPER THERMIC	III	43
09999 <b>2728</b>	Terminal de 16,5 mm con puntal cincado NC 45 INTERNATIONAL / SUPER THERMIC - NC 55 - INTERNATIONAL NC 65 / 68 / 72 SUPER THERMIC	III	43
09999 <b>2730</b>	Terminal de 18 mm con puente de unión para varilla cremona y puntal cincado	III	43
09999 <b>2731</b>	Terminal de 19,5 mm con puntal inox DOMAL BREAK / GELOSIA / STOPPER PG - GOLD - ALL.CO K40 / 5TT / P4 / EXPORT - EKIP 40 - nuevo NC 40	III	45
09999 <b>2732</b>	Terminal de 19,5 mm con puntal cincado DOMAL BREAK / GELOSIA / STOPPER PG - GOLD - ALL.CO K40 / 5TT / P4 / EXPORT - EKIP 40 - nuevo NC 40	III	45
09999 <b>2733</b>	Terminal de 18 mm con puente de unión para varilla cremona y puntal descentrado inox R 40 / R 50 TT / R 62 / R 72 - NEW TEC 50 / 52 / 60 / 68 ST - ESEDRA GA 53 - ESEDRA LIGHT 42 / 50 - ESEDRA TT 63 / TT 75	III	44
09999 <b>2734</b>	Terminal de 18 mm con puente de unión para varilla cremona y puntal descentrado cincado R 40 / R 50 TT / R 62 / R 72 - NEW TEC 50 / 52 / 60 / 68 ST - ESEDRA GA 53 - ESEDRA LIGHT 42 / 50 - ESEDRA TT 63 / TT 75	III	44
09999 <b>2735</b>	Tirador de pasador de 16,5 con unión para terminal NC 45 INTERNATIONAL / SUPER THERMIC - NC 55 INTERNATIONAL - NC 65 / 68 / 72 SUPER THERMIC	III	42
09999 <b>2736</b>	Tirador de pasador de 18 con unión para terminal R 40 / R 50 TT / R 62 / R 72 - NEW TEC 50 / 52 / 60 / 68 ST - ESEDRA GA 53 - ESEDRA LIGHT 42 / 50 - ESEDRA TT 63 / TT 75	III	42
09999 <b>2737</b>	Tirador de pasador de 19,5 con unión para terminal DOMAL BREAK / GELOSIA / STOPPER PG - GOLD - ALL.CO K40 / 5TT / P4 / EXPORT - EKIP 40 - nuevo NC 40	III	42
09999 <b>2738</b>	Pasador de 16,5 mm con puntal inox NC 45 INTERNATIONAL / SUPER THERMIC - NC 55 INTERNATIONAL - NC 65 / 68 / 72 SUPER THERMIC	III	47
09999 <b>2739</b>	Pasador de 16,5 mm con puntal cincado NC 45 INTERNATIONAL / SUPER THERMIC - NC 55 INTERNATIONAL - NC 65 / 68 / 72 SUPER THERMIC	III	47
09999 <b>2742</b>	Pasador de 19,5 mm con puntal inox DOMAL BREAK / GELOSIA / STOPPER PG - GOLD - ALL.CO K40 / 5TT / P4 / EXPORT - EKIP 40 - nuevo NC 40	III	50
09999 <b>2743</b>	Pasador de 19,5 mm con puntal cincado DOMAL BREAK / GELOSIA / STOPPER PG - GOLD - ALL.CO K40 / 5TT / P4 / EXPORT - EKIP 40 - nuevo NC 40	III	50
09999 <b>2744</b>	Pasador de 18 mm con puntal inox y puente de union R 40 / R 50 TT / R 62 / R 72 - NEW TEC 50 / 52 / 60 / 68 ST - ESEDRA GA 53 - ESEDRA LIGHT 42 / 50 - ESEDRA TT 63 / TT 75	III	48
09999 <b>2745</b>	Pasador de 18 mm con puntal cincado y puente de union R 40 / R 50 TT / R 62 / R 72 - NEW TEC 50 / 52 / 60 / 68 ST - ESEDRA GA 53 - ESEDRA LIGHT 42 / 50 - ESEDRA TT 63 / TT 75	III	48
09999 <b>2747</b>	Manilla CRISTINA en resina MATE con escudo oval y muelle de recuperación (Patentada)	IV	60
09999 <b>2748</b>	Manilla CRISTINA en resina BRILLANTE con escudo oval y muelle de recuperación (Patentada)	IV	60
09999 <b>2749</b>	Manilla CRISTINA en resina MATE con escudo redondo y muelle de recuperación (Patentada)	IV	61
09999 <b>2750</b>	Manilla CRISTINA en resina BRILLANTE con escudo redondo y muelle de recuperación (Patentada)	IV	61
09999 <b>2751</b>	Manilla TATA en resina con muelle de recuperación	IV	66
09999 <b>2752</b>	BRUCO cierra ventana abisagrada 2 hojas manualcon tornillos brunidos	I	7
09999 <b>2753</b>	Manilla CRISTINA en aluminio con escudo oval y muelle de recuperación (Patentada)	IV	63
09999 <b>2754</b>	Manilla CRISTINA en aluminio con escudo redondo y muelle de recuperación (Patentada)	IV	64
09999 <b>2755</b>	Manilla CRISTINA en resina MATE con escudo oval sin muelle de recuperación (Patentada)	IV	60
09999 <b>2756</b>	Manilla CRISTINA en resina BRILLANTE con escudo oval sin muelle de recuperación (Patentada)	IV	60
09999 <b>2757</b>	Manilla CRISTINA en resina MATE con escudo redondo sin muelle de recuperación (Patentada)	IV	62
09999 <b>2758</b>	Manilla CRISTINA en resina BRILLANTE con escudo redondo sin muelle de recuperación (Patentada)	IV	62
09999 <b>2759</b>	Manilla TATA en resina con clavija y muellede recuperación	IV	66
09999 <b>2764</b>	Espesores carga cristal ANGEL de 2 mm R 40 REVAMPING - R 50 TT	VI	104
09999 <b>2765</b>	Espesores carga cristal ANGEL de 5 mm R 40 REVAMPING - R 50 TT	VI	104
09999 <b>2766</b>	Espesores carga cristal ANGEL de 5,5 mm con orificio R 40 REVAMPING - R 50 TT	VI	104
09999 <b>2767</b>	Espesores carga cristal ANGEL de 10,5 mm con orificio R 40 REVAMPING - R 50 TT	VI	104
09999 <b>2768</b>	Escudo oval en resina para llave PATENT serie TATA	IV	68
09999 <b>2773</b>	Soporte reversible persiana fija perfil cristal inserción cámara máx. 25x24 mm - mín. 18 mm para lama ovalina 50x10 mm	VI	89
09999 <b>2774</b>	Terminal soporte reversible persiana fija perfil cristal inserción cámara máx. 25x24mm - mín. 18mm para lama ovalina 50x10 mm	VI	89

CÓDIGO	DESCRIPCIÓN	CAP	PAG
099992777	Juego tapón inversor ALL.CO EXPORT 45 - 45 TT	II	24
099992778	Juego tapón inversor R 50 TT con mezzaluna half-moon media luna	II	23
099992779	Juego tapón inversor R 50	II	23
099992781	Bisagra para mosquitera practicable sin muelle con placa para perfil R40	III	36
099992782	Bisagra para mosquitera practicable con muelle y placa, eje regulable en zamak para perfil R40	III	36
099992784	Blister de 100 soporte reversible persiana fija tipo genovés para lama ovalina 50x10 mm FB 12 - METRA - ALL.CO - ALCAN - ABITHAL	VI	86
099992786	Juego tapón inversor ALL.CO 5 sormonto overlapped part solapado	II	24
099992787	Juego tapón inversor ALL.CO EXPORT 50	II	24
099992788	Juego tapón inversor ALL.CO EXPORT 50 TT	II	24
099992789	Encuentro doble varilla con 2 clavijas inox EXPORT - EKU - GOLD	III	56
099992790	Encuentro doble varilla con 1 clavija inox SISTEMA 1 - nuevo NC 40	III	56
099992793	Juego tapón inversor ALL.CO WOOD	II	24
099992794	Terminal dch-izd de 18 mm con puente de unión para varilla cremona y puntal plano cincado R 40 / R 50 TT / R 62 / R 72 - NEW TEC 50 / 52 / 60 / 68 ST - ESEDRA GA 53 - ESEDRA LIGHT 42 / 50 - ESEDRA TT 63 / TT 75	III	44
099992795	Pasador de 18 mm con puntal cincado plano y puente de unión varilla Cremona R 40 / R 50 TT / R 62 / R 72 - NEW TEC 50 / 52 / 60 / 68 ST - ESEDRA GA 53 - ESEDRA LIGHT 42 / 50 - ESEDRA TT 63 / TT 75	III	49
099992797	Juego tapón inversor nuevo NC 40 METRA	II	25
099992798	Espesores carga cristal ANGEL de 5,5 mm con orificio: R 40 - R 50 giunto aperto	VI	104
099992799	CHIOCCIOLA cierre de presión con espesor de 2,5 mm, tornillos acero inoxidable y tapones	III	34
099992800	CHIOCCIOLA cierre de presión dch-izd con espesor de 2,5 mm, tornillos acero inoxidable y tapones	III	34
099992801	Escuadra de alineación R 40 - R 50	VI	102
099992802	Terminal de 19,5 mm con puntal inox de 20 mm DOMAL BREAK / GELOSIA / STOPPER PG - GOLD - ALL.CO K40 / 5TT / P4 / EXPORT - EKIP 40 - nuevo NC 40	III	46
099992803	Terminal dch-izd de 18 mm con puente de unión para varilla cremona y puntal inox de 20 mm R 40 / R 50 TT / R 62 / R 72 - NEW TEC 50 / 52 / 60 / 68 ST - ESEDRA GA 53 - ESEDRA LIGHT 42 / 50 - ESEDRA TT 63 / TT 75	III	44
099992804	Pasador de 19,5 mm con puntal inox y varillade 20 mm DOMAL BREAK / GELOSIA / STOPPER PG - GOLD - ALL.CO K40 / 5TT / P4 / EXPORT - EKIP 40 - nuevo NC 40	III	50
099992805	Pasador de 18 mm con puntal inox de 20 mm R 40 / R 50 TT / R 62 / R 72 - NEW TEC 50 / 52 / 60 / 68 ST - ESEDRA GA 53 - ESEDRA LIGHT 42 / 50 - ESEDRA TT 63 / TT 75	III	48
099992806	Juego tapón inversor DOMAL 40	II	25
099992807	Juego tapón inversor DOMAL STOPPER PG 19664-23251	II	25
099992812	Encuentro doble varilla con 2 clavijas inox ALL.CO 5 / 5 TT - R 40 / 50 TT / R 62 / R 72 - NEW TEC 50 / 52 / 60 / 68 ST - ESEDRA GA 53 - ESEDRA LIGHT 42 / 50 - ESEDRA TT 63 / TT 75	III	55
099992813	Juego tapón inversor R 40 recto y redondeado histórico	II	24
099992814	Extensión pasadores	III	51
099992815	Manilla TATA en resina con maneta alta para cierre persiana	IV	67
099992817	Kit una hoja DOMAL BREAK / GELOSIA / STOPPER PG - GOLD - ALL.CO K40 / 5TT / P4 / EXPORT - EKIP 40 - nuevo NC 40	III	51
099992818	Kit dos hojas DOMAL BREAK / GELOSIA / STOPPER PG - GOLD - ALL.CO K40 / 5TT / P4 / EXPORT - EKIP 40 - nuevo NC 40	III	52
099992822	Kit una hoja R 40 / R 50 TT / R 62 / R 72 - NEW TEC 50 / 52 / 60 / 68 ST - ESEDRA GA 53 - ESEDRA LIGHT 42 / 50 - ESEDRA TT 63 / TT 75	III	51
099992828	Juego tapón inversor R 40 dritto straight recto	II	24
099992838	Clip junquillo ALFIL 45 DOMAL BREAK 70S	I	11
099992840	Escuadra de alineación ETNALL ET4322 - G40/G2019 - ATLANTIS AZ 2109	VI	103
099992842	Kit hoja fija DOMAL BREAK / GELOSIA / STOPPER PG - GOLD - ALL.CO K40 / 5TT / P4 / EXPORT - EKIP 40 - nuevo NC 40	III	42
099992844	Tapa vierteaguas DOMAL 40 / BREAK / STOPPER - ALL.CO 5 - P4 - EXPORT 40 / 50 / 60	II	22
099992846	Escuadra de alineación R 40	VI	102
099992847	Escuadra de alineación cerrada R 40	VI	102
099992848	Juego tapón inversor DOMAL STOPPER PG 19663	II	25
099992849	Tapón perfil pasamano ETNALL ET 4322 - G 40 / G2019 - ATLANTIS AZ 2109	II	23
099992850	Juego tapón inversor DOMAL BREAK PA 52	II	25
099992851	Tirador plano de pasador de 18 R 40 / R 50 TT / R 62 / R 72 - NEW TEC 50 / 52 / 60 / 68 ST - ESEDRA GA 53 - ESEDRA LIGHT 42 / 50 - ESEDRA TT 63 / TT 75	III	43
099992852	Terminal dch-izd de 18 mm con puntal plano cincado R 40 / R 50 TT / R 62 / R 72 - NEW TEC 50 / 52 / 60 / 68 ST - ESEDRA GA 53 - ESEDRA LIGHT 42 / 50 - ESEDRA TT 63 / TT 75	III	45
099992853	Pasador de 18 mm con puntal cincado plano R 40 / R 50 TT / R 62 / R 72 - NEW TEC 50 / 52 / 60 / 68 ST - ESEDRA GA 53 - ESEDRA LIGHT 42 / 50 - ESEDRA TT 63 / TT 75	III	49
099992854	Tapones terminal dch-izd ALL.CO P4 VZ 0785 / VZ 0755D	II	21
099992858	Varilla moldurada para pasador DOMAL 40 3ª hoja	III	52

CÓDIGO	DESCRIPCIÓN	CAP	PAG
09999 <b>2859</b>	Puente de unión para pasador DOMAL 40 3ª hoja	III	53
09999 <b>2860</b>	Soporte reversible persiana fija perfiles cristal inserción cámara 25x19,3 mm para lama ovalina 50x10 mm	VI	89
09999 <b>2861</b>	Juego conexión Cremona DOMAL BREAK / GELOSIA / STOPPER PG - GOLD - ALL.CO K40 / 5TT / P4 / EXPORT - EKIP 40 - nuevo NC 40	VI	103
09999 <b>2862</b>	Espesor moleteado para cámara vidrio 20x2 mm	VI	104
09999 <b>2863</b>	Espesor moleteado para cámara vidrio 20x3 mm	VI	105
09999 <b>2864</b>	Espesor moleteado para cámara vidrio 20x4 mm	VI	105
09999 <b>2865</b>	Espesor moleteado para cámara vidrio 20x5 mm	VI	105
09999 <b>2866</b>	Espesor moleteado para cámara vidrio 20x7 mm	VI	105
09999 <b>2867</b>	Tapón de soldar para cerramientos en PVC con perfil tubular de 40x40x1,5 mm	VI	112
09999 <b>2870</b>	Kit de 20 soporte reversible persiana fija tipo genovés para lama ovalina 50x10 mm FB 12 - METRA - ALL.CO - ALCAN - ABITHAL	VI	86
09999 <b>2872</b>	Kit de 20 soporte reversible persiana fija tipo genovés para lama tipo centro histórico 65x10 mm	VI	92
09999 <b>2874</b>	Tapón de soldar para cerramientos en PVC con perfil tubular de 40x40x2 mm	VI	113
09999 <b>2879</b>	Escuadra polivalente para mosquitera asimétrico, corredera horizontal o vertical, con tornillos M5 x 11,4 (Patentada)	VI	111
09999 <b>2886</b>	Tapón de soldar para cerramientos en PVC con perfil tubular de 40x40x1 mm	VI	112
09999 <b>2888</b>	Escuadra de alineación aletas ALL.CO 5 - ALL.CO P4	VI	102
09999 <b>2889</b>	Bloque soporte placa bisagra ALL.CO WOOD	VI	103
09999 <b>2893</b>	CLAC Cierre golpete con tornillo visto y espesores de compensación de 1-2-3-7 mm	III	35
09999 <b>2894</b>	CLIC Cierre golpete con tornillo oculto y espesores de compensación de 1-2-3-7 mm	III	35
09999 <b>2895</b>	Terminal de 19,5 mm con puntal inox de 20 mm DOMAL BREAK / GELOSIA / STOPPER PG - GOLD - ALL.CO K40 / 5TT / P4 / EXPORT - EKIP 40 - nuevo NC 40	III	47
09999 <b>2897</b>	Manilla mosquitera para corredera horizontal o vertical	VI	112
09999 <b>2898</b>	Base con rodamiento para puerta	I	7
09999 <b>2899</b>	Terminal dch-izd de 18 mm con puntalinox de 20 mm R 40 / R 50 TT / R 62 / R 72 - NEW TEC 50 / 52 / 60 / 68 ST - ESEDRA GA 53 - ESEDRA LIGHT 42 / 50 - ESEDRA TT 63 / TT 75	III	45
09999 <b>2900</b>	Pasador de 18 mm con puntal inox de 20 mm R 40 / R 50 TT / R 62 / R 72 - NEW TEC 50 / 52 / 60 / 68 ST - ESEDRA GA 53 - ESEDRA LIGHT 42 / 50 - ESEDRA TT 63 / TT 75	III	49
09999 <b>2904</b>	Pasador de 19,5 mm con puntal inox y varilla de 20 mm	III	50
09999 <b>2905</b>	Juego conexión Cremona R 40 - NEW TEC - NEW 50 / 52 TT / 60 TT	VI	103
09999 <b>2906</b>	Pasador para mosquitera de 16,5 mm con puntal cincado blanco	III	47
09999 <b>2907</b>	Tapa vierteaguas para orificio orbicular 31x6 mm	II	22
09999 <b>2916</b>	Perfil porta felpa de m 3 para cámara de 25 mm	II	26
09999 <b>2917</b>	Espesores de 2 mm para marco y contramarco	VI	107
09999 <b>2918</b>	Espesores de 3 mm para marco y contramarco	VI	107
09999 <b>2919</b>	Espesores de 5 mm para marco y contramarco	VI	107
09999 <b>2920</b>	Unión con espesores nuevo NC - ETNALL ET43 - ATLANTIS serie 40 - G40	VI	102
09999 <b>2921</b>	Ruleta inserción junta central WIND STOP 45 TT / 55 TT (PONZIO)	V	78
09999 <b>2924</b>	Encuentro varilla con 2 clavijas inox y 2 casquillos ALL.CO 5S / 5STT	III	55
09999 <b>2925</b>	Terminal de 19,5 mm con puntal inox de Ø 8x20	III	46
09999 <b>2926</b>	Encuentro simple inferior varilla para cámara de 14 mm con tuercade mariposa inoxde 19,5 mm Persiana KL	III	53
09999 <b>2928</b>	Espesores de 4 mm para marco y contramarco	VI	107
09999 <b>2931</b>	Terminal de 19,5 mm con puntal rectangularde 14 mm persiana KL	III	46
09999 <b>2935</b>	Distanciador abierto Dch-Izd para lama ovalina 50x10 mm persiana KL	VI	94
09999 <b>2936</b>	Compensador Dch-Izd persiana - shutter KL	VI	93
09999 <b>2937</b>	Escudo oval en aluminio para bombín oval serie CRISTINA	IV	63
09999 <b>2938</b>	Escudo oval en aluminio para bombín moldeado serie CRISTINA	IV	63
09999 <b>2939</b>	Escudo oval en aluminio para llave PATENT serie CRISTINA	IV	63
09999 <b>2940</b>	Tapa vierteaguas (orificios Ø4 distancia entre ejes 48)	II	22
09999 <b>2952</b>	RENATO (Patentado) brazo dch-izd para abatibles en aluminium DOMAL BREAK - GELOSIA STOPPER PG - GOLD / EXPORT - EKIP 40 - ALL.CO K40 / 5TT / P4 - nuevo NC40 - R40 / R 50TT / R 62 / R 72 - NEW TEC 50 / 52 / 60 / 68ST ESEDRA GA 53 - ESEDRA LIGHT 42/50 - ESEDRA TT 63 / TT 75	III	32
09999 <b>2953</b>	SCARABEO (Patentado) cierre para puertas y ventanas abatibles en aluminio con superposición max bastidor- hoja de 0-12 mm y cuerda de 4 m	III	30
09999 <b>2954</b>	Juego tapón inversor EKU 45 17675	II	26
09999 <b>2955</b>	Tapones terminal dch-izd EKU 45 T.E.S. 17675	II	20
09999 <b>2956</b>	Tapones terminal dch-izd EKU 45 T.E.S. 17677 / 17678 hoja	II	20
09999 <b>2957</b>	Espesor para manillas serie CRISTINA con escudo oval y manillas TATA para perfiles redondeados	IV	66

CÓDIGO	DESCRIPCIÓN	CAP	PAG
099992960	Manilla NUOVA EMOZIONE en resina con escudo oval	IV	65
099992961	Bisagra para mosquitera practicable sin muelle con dientes de 14,6 mm	III	38
099992962	Bisagra para mosquitera practicable con muelle, dientes de 14,6 mm y eje regulable en zamak	III	38
099992963	Kit excéntrica cincada de 16,6 mm y tornillo inox cabeza avellanada TSP M5 x 8	III	39
099992964	PEPITO (Patentado) retenedor de hoja automático en acero inox	I	5
099992965	Kit cubiertas para SCARABEO	III	31
099992966	Kit espesores para SCARABEO estampado en color negro	III	31
099992967	Guía de persiana GRIFFEL PONS 10679	I	10
099992968	Kit espesores barnizados para SCARABEO	III	31
099992969	Encuentro doble inferior varilla para cámarade 14 mm con tuercade mariposa inoxde 19,5 mm Persiana KL	III	54
099992970	Distanciador Ø 15x16,5 mm R 40 - R 50 - ALL.CO 5 - ALL.CO P4 - ALPHA 445 / 545 / 658 TT	VI	105
099992971	Distanciador Ø 15x34 mm universal	VI	106
099992972	Distanciador Ø 19x16,5 mm TRIALCO - ALL.CO 5	VI	106
099992973	Distanciador Ø 25x21 mm ESEDRA - EXPORT - ALL.CO 5	VI	106
099992974	Distanciador Ø 15x20,5 mm nuevo NC 40 - NC 45 INTERNATIONAL - EKIP - EXPORT - DOMAL STOPPER	VI	105
099992975	Distanciador Ø 19x20,5 mm	VI	106
099992976	Distanciador Ø 25x21 mm universal	VI	106
099992977	Guía de persiana GRIFFEL PONS 60869	I	10
099992982	Escudo maxi para retenedor de hoja automático	I	5
099992984	DIMA plantilla para montaje SCARABEO	III	30
099992988	Brazo oculto cierra ventana manual	I	7
099992989	Cuerda de 6 m para SCARABEO	III	32
099992991	Espesor escuadra rotura puente termico	VI	103
099992998	SCARABEO (Patentado) Cierre para puertas y ventanas abatiblescon superposición máx. bastidor - hoja de 0 a 12 mm y cuerda de 4 m	III	30
099992999	RENATO (Patentado) brazo dch-izd para abatibles en madera y pvc	III	32
099993000	SUPER TOP GRILLO (Patentado) retenedor de hoja automático con tornillo de 70 mm.	I	2
099993001	SUPER TOP GRILLO (Patentado) retenedor de hoja automático con tornillo de 120 mm.	I	2
099993002	SUPER TOP GRILLO (Patentado) retenedor de hoja automático con amortiguador y tornillo de 70 mm.	I	2
099993003	SUPER TOP GRILLO (Patentado) retenedor de hoja automático con amortiguador y tornillo de 120 mm.	I	2
099993004	SUPER TOP GRILLO (Patentado) retenedor de hoja automático con retenedor sobredimensionado y tornillo de 70 mm.	I	2
099993005	SUPER TOP GRILLO (Patentado) retenedor de hoja automático sobredimensionado y tornillo de 120 mm.	I	2
099993006	SUPER TOP GRILLO (Patentado) retenedor de hoja automático con retenedor sobredimensionado, con amortiguador y tornillo de 70 mm.	I	2
099993007	SUPER TOP GRILLO (Patentado) retenedor de hoja automático con retenedor sobredimensionado, con amortiguador y tornillo de 120 mm.	I	2
099993008	SUPER MIDI GRILLO (Patentado) retenedor de hoja automático con tornillo de 70 mm.	I	3
099993009	SUPER MIDI GRILLO (Patentado) retenedor de hoja automático con tornillo de 120 mm.	I	3
099993010	SUPER MIDI GRILLO (Patentado) retenedor de hoja automático con amortiguador y tornillo de 70 mm.	I	3
099993011	SUPER MIDI GRILLO (Patentado) retenedor de hoja automático con amortiguador y tornillo de 120 mm.	I	3
099993012	SUPER MAXI GRILLO (Patentado) retenedor de hoja doble automático con tornillode 70 mm	I	4
099993013	SUPER MAXI GRILLO (Patentado) retenedor de hoja doble automático con tornillode 120 mm	I	4
099993015	SUPER MAXI GRILLO (Patentado) retenedor de hoja doble automáticocon amortiguador y tornillo de 70 mm	I	4
099993016	SUPER MAXI GRILLO (Patentado) retenedor de hoja doble automáticocon amortiguador y tornillo de 120 mm	I	4
099993018	SUPER TOP GRILLO (Patentado) retenedor de hoja automático con regulación maxi, y tornillo de 70 mm.	I	3
099993019	SUPER TOP GRILLO (Patentado) retenedor de hoja automático con regulación maxi, amortiguador y tornillo de 70 mm.	I	3
099993020	SUPER MIDI GRILLO (Patentado) retenedor de hoja automático con amortiguador y tornillo de 150 mm.	I	3
099993021	Soporte gancho marco perimetral	III	56
099993022	Distanciador hoja S/tradicionales 17,3x7,3 mm	III	56
099993023	Distanciador hoja 23,3x14 mm	III	57
099993024	Distanciador hoja 23,3x11 mm	III	57
099993027	Pasador de 18 mm con puntal cincado y puente de union	III	48
099993028	Kit cubiertas para SCARABEO estampado en color negro	III	31
099993034	Llave plegada para rotación bloque de ensamblaje (cód. 1638) perfiles madera / aluminio	V	81
099993035	SUPER TOP GRILLO (Patentado) retenedor de hoja automático con tornillo de 150 mm.	I	2
099993036	SUPER TOP GRILLO (Patentado) retenedor de hoja automático con amortiguador y tornillo de 150 mm.	I	2

CÓDIGO	DESCRIPCIÓN	CAP	PAG
09999 <b>3037</b>	SUPER MAXI GRILLO (Patentado) retenedor de hoja doble automático con tornillode 150 mm	I	4
09999 <b>3039</b>	Juego conexión cremona sobredimensionado	VI	103
09999 <b>3042</b>	Distanciador hoja 27,7x10,2 mm	III	57
09999 <b>3047</b>	Soporte reversible persiana fija para perfiles cámara 14x35 mm ovalina 50x10 mm	VI	88
09999 <b>3048</b>	Compensadore dch-izq persiana fija para perfiles cámara mm 36x17 ovalina mm 50x10	VI	88
09999 <b>3049</b>	Soporte gancho marco abierto 9,8x10 mm	III	57
09999 <b>3050</b>	Soporte gancho marco abierto 7x12 mm	III	57
29999 <b>0825</b>	Empuñadura de dosbrazos para ruletainserción juntas	V	79
29999 <b>0827</b>	Empuñadura de unbrazo para ruletainserción junta	V	79
31000 <b>8800</b>	Varilla AVP $\varnothing$ 8	IV	71
69999 <b>0129</b>	Tapón semirredondo pequeño	VII	119
69999 <b>0149</b>	Pareja de ganchos para cortina	VII	119
69999 <b>0150</b>	Tope persiana mallorquina marco abierto	VII	124
69999 <b>0155</b>	Bloque guía 40X18	VII	117
69999 <b>0156</b>	Encaje resorte GR 9	VII	116
69999 <b>0157</b>	Cubre ángulo GR 9	VII	116
69999 <b>0158</b>	Cubre ángulo NC 40-50	VII	116
69999 <b>0159</b>	Tapón 20x10	VII	120
69999 <b>0160</b>	Tapón $\varnothing$ 12	VII	117
69999 <b>0161</b>	Tapón $\varnothing$ 14	VII	117
69999 <b>0163</b>	Tapón 50x50	VII	122
69999 <b>0164</b>	Tapón 25x25	VII	120
69999 <b>0165</b>	Tapón 30x30	VII	121
69999 <b>0166</b>	Tapón 20x20	VII	120
69999 <b>0167</b>	Tapones pasamano	VII	118
69999 <b>0168</b>	Tapón 40x20	VII	121
69999 <b>0169</b>	Encaje resorte NC	VII	116
69999 <b>0172</b>	Bloque guía 50X25	VII	117
69999 <b>0173</b>	Pernio bisagra mm 11	VII	118
69999 <b>0174</b>	Tapón 20x80	VII	120
69999 <b>0175</b>	Tapón 40x60	VII	121
69999 <b>0176</b>	Encaje universal	VII	116
69999 <b>0177</b>	Tapón trapezoidal pequeño	VII	119
69999 <b>0178</b>	Paragolpe GR 9	VII	116
69999 <b>0179</b>	Paragolpe NC 40-50	VII	117
69999 <b>0180</b>	Tapón 30x20	VII	121
69999 <b>0182</b>	Tapón 30x60	VII	121
69999 <b>0183</b>	Tapón 15x30	VII	119
69999 <b>0184</b>	Tapón 20x100	VII	120
69999 <b>0185</b>	Bloque guía 40X19 GR 9	VII	117
69999 <b>0187</b>	Tapón trapezoidal grande	VII	119
69999 <b>0188</b>	Tapón 40x40	VII	121
69999 <b>0189</b>	Casquillo para encaje $\varnothing$ 6	VII	118
69999 <b>0190</b>	Tapón 40x80	VII	122
69999 <b>0349</b>	Tijeras de metal LÖWE	VII	124
69999 <b>0634</b>	Tapón 15x80	VII	119
69999 <b>0824</b>	Tapón 25x50	VII	120
69999 <b>0950</b>	Escuadra marco de ventana para mosquitera corredera y alzable	VII	123
69999 <b>0954</b>	Retenedor compensador para mosquiterera corredera y alzable	VII	123
69999 <b>0967</b>	Encuentro de suelo antipolvo $\varnothing$ 6	VII	124
69999 <b>0968</b>	Encuentro de suelo antipolvo $\varnothing$ 8	VII	124
69999 <b>0969</b>	Encuentro de suelo antipolvo $\varnothing$ 10	VII	124
69999 <b>1510</b>	Perno bisagra $\varnothing$ 11	VII	118







# CHIAVE DI LETTURA CODICI

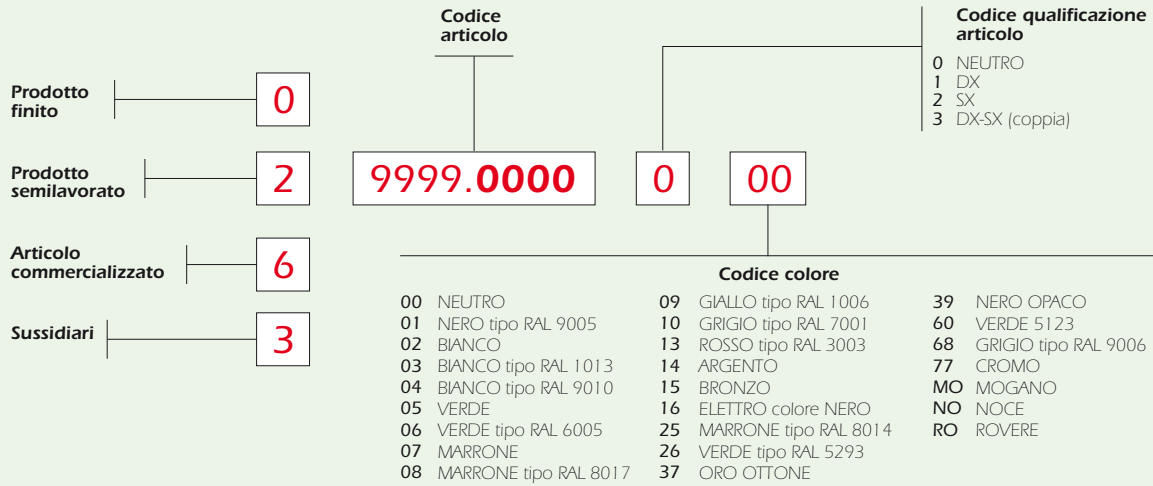

# CODE RECOGNITION KEY

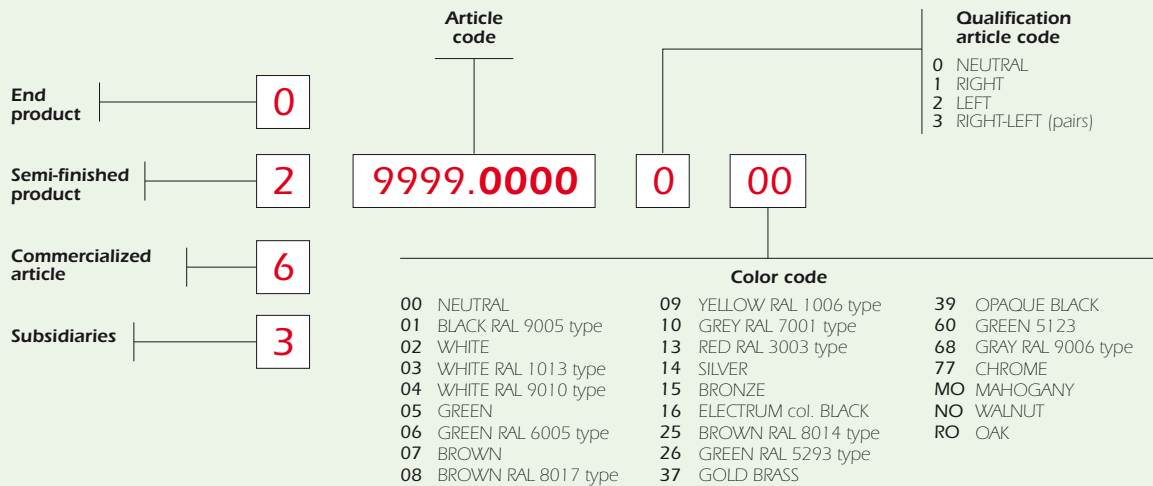

# CLAVE DE LECTURA CÓDIGOS

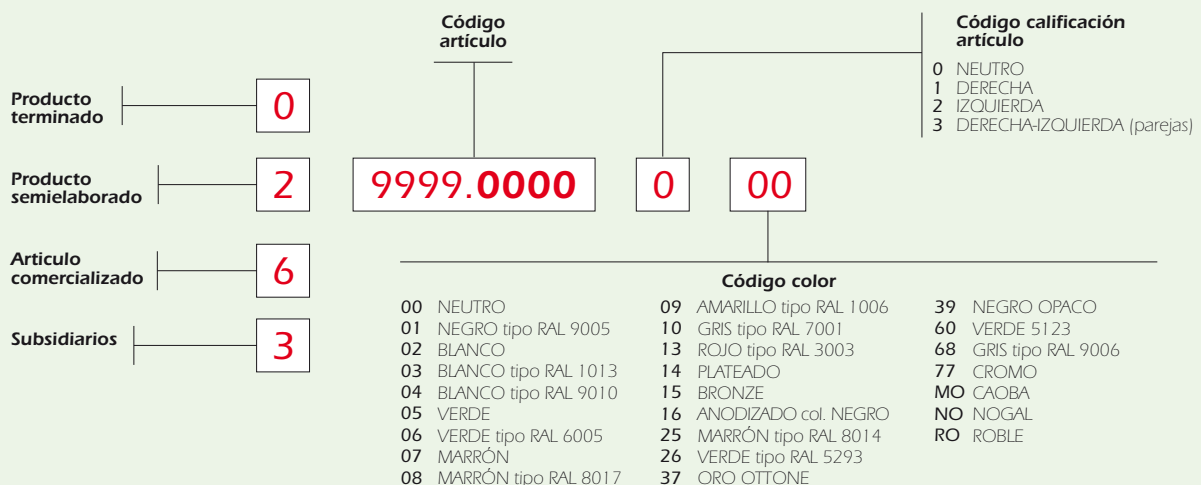

2 11	SISTEMI DI BLOCCAGGIO BLOCKING SYSTEMS SISTEMAS DE BLOQUEO	I
14 27	TAPPI PROFILATI PLUGS FOR PROFILES TAPONES PARA PERFILES	II
30 57	SISTEMI DI CHIUSURA CLOSING SYSTEMS SISTEMAS DE CIERRE	III
60 73	MANIGLIE E MANIGLIONI HANDLES AND PULL HANDLE MANILLAS Y TIRADORES	IV
76 83	ATTREZZATURE PER SERRAMENTI ACCESSORIES FOR WINDOW AND DOOR FRAMES ACCESORIOS PARA HERRAJES	V
86 113	ACCESSORI PER ASSEMBLAGGIO ACCESSORIES FOR ASSEMBLY ACCESORIOS PARA ENSAMBLAR	VI
116 125	ARTICOLI COMMERCIALIZZATI COMMERCIALIZED ARTICLE ARTICULO COMERCIALIZADO	VII

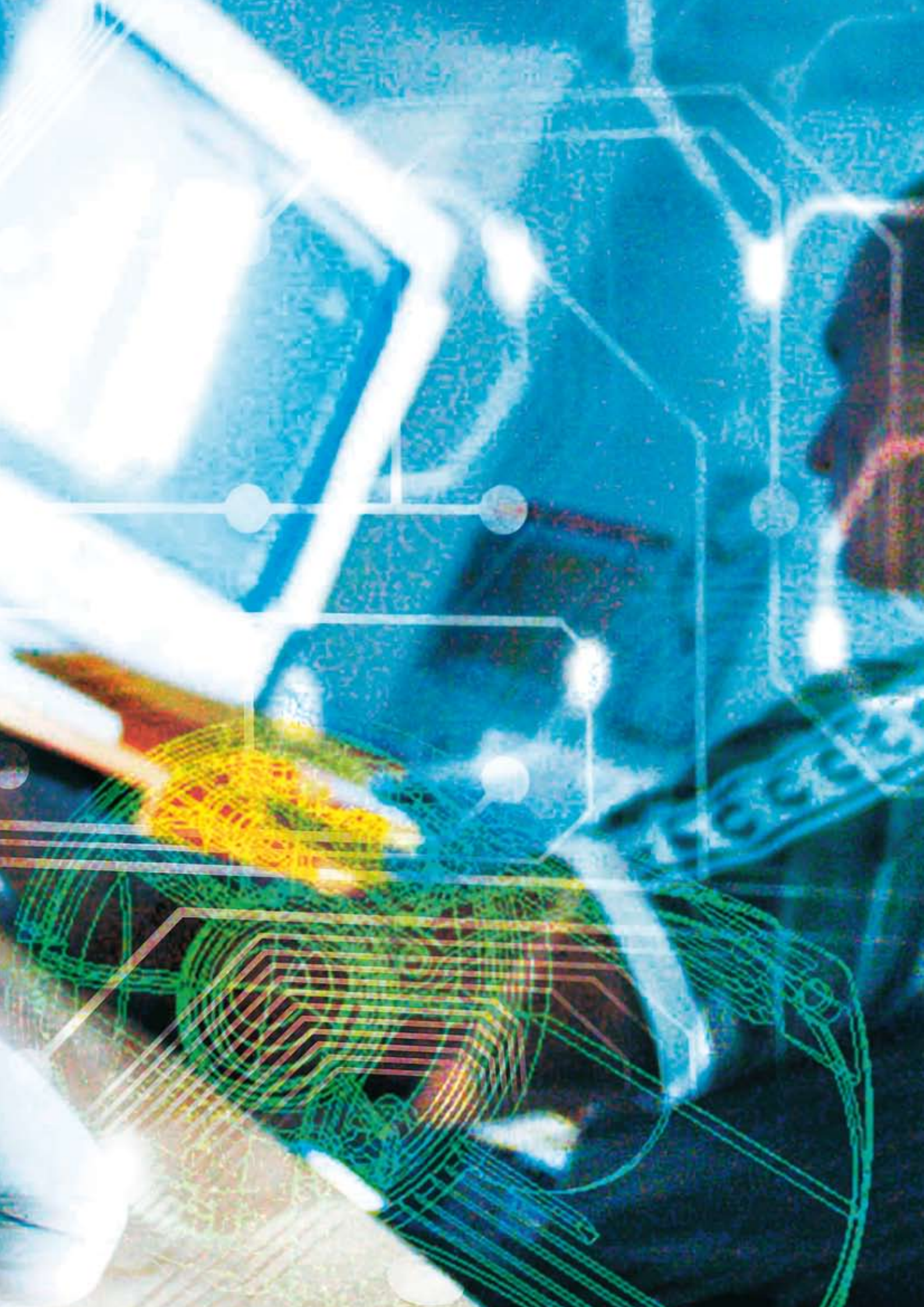

# SISTEMI DI BLOCCAGGIO





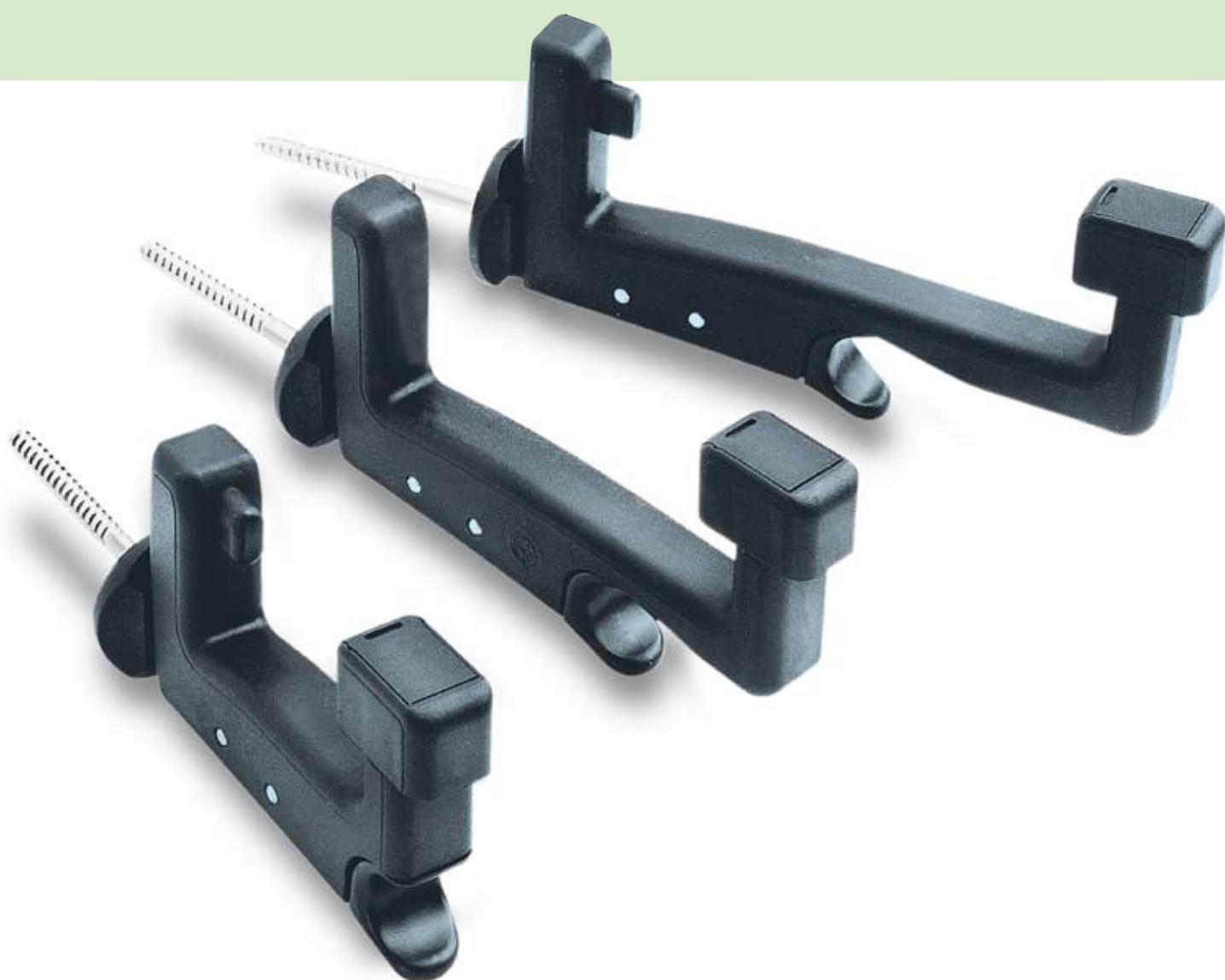

BLOCKING  
SYSTEMS

SISTEMAS DE  
BLOQUEO





Art. 099993018.0 01 03	DESCRIZIONE DESCRIPTION DESCRIPCIÓN	MATERIALE MATERIAL MATERIALE	SCATOLA BOX CAJA
	<p><b>SUPER TOP GRILLO</b> (Brevettato) fermo imposta automatico con tassello di regolazione maxi e vite da mm 70</p> <p><b>SUPER TOP GRILLO</b> (Patented) automatic shutter lock with maxi regulation plug and screw 70 mm</p> <p><b>SUPER TOP GRILLO</b> (Patentado) retenedor de hoja automático con regulación maxi, y tornillo de 70 mm</p>	PA	25 Pz
	<p><b>SUPER TOP GRILLO</b> (Brevettato) fermo imposta automatico con tassello di regolazione maxi, ammortizzatore e vite da mm 70</p> <p><b>SUPER TOP GRILLO</b> (Patented) automatic shutter lock with maxi regulation plug shock absorber and screw 70 mm</p> <p><b>SUPER TOP GRILLO</b> (Patentado) retenedor de hoja automático con regulación maxi, amortiguador y tornillo de 70 mm</p>	PA	25 Pz
<p>Art. 099993008.0 01 03 L 70 mm</p> <p>099993009.0 01 03 L 120 mm</p> <p>099993020.0 01 03 L 150 mm</p> 	<p><b>SUPER MIDI GRILLO</b> (Brevettato) fermo imposta automatico con vite da mm 70 - 120 - 150</p> <p><b>SUPER MIDI GRILLO</b> (Patented) automatic shutter lock with 70 - 120 - 150 mm screw</p> <p><b>SUPER MIDI GRILLO</b> (Patentado) retenedor de hoja automático con tornillo de 70 - 120 - 150 mm</p>	PA	20 Pz
<p>Art. 099993010.0 01 03 L 70 mm</p> <p>099993011.0 01 03 L 120 mm</p> 	<p><b>SUPER MIDI GRILLO</b> (Brevettato) fermo imposta automatico con ammortizzatore e vite da mm 70 - 120</p> <p><b>SUPER MIDI GRILLO</b> (Patented) automatic shutter lock with shock absorber and 70 - 120 mm screw</p> <p><b>SUPER MIDI GRILLO</b> (Patentado) retenedor de hoja automático con amortiguador y tornillo de 70 - 120 mm</p>	PA	20 Pz





16  
 eletto col. nero  
 electrum col. black  
 anodizado col. negro

25  
 marrone 8014  
 brown 8014  
 marrone 8014

26  
 verde 5293  
 gothic 5293  
 verde 5293

37  
 ottone  
 brass  
 ottone

39  
 nero opaco  
 opaque black  
 negro opaco

60  
 verde 5123  
 green 5123  
 verde 5123



68  
 grigio 9006  
 gothic 9006  
 gris 9006

77  
 cromo  
 chrome  
 cromo

MO  
 mogano  
 mahogany  
 caoba

NO  
 noce  
 walnut  
 nogal

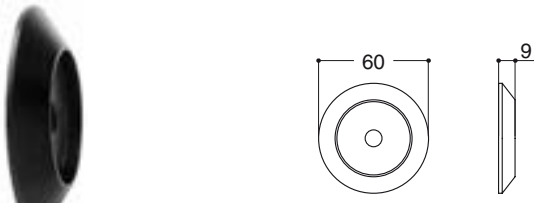
RO  
 rovere  
 oak  
 roble

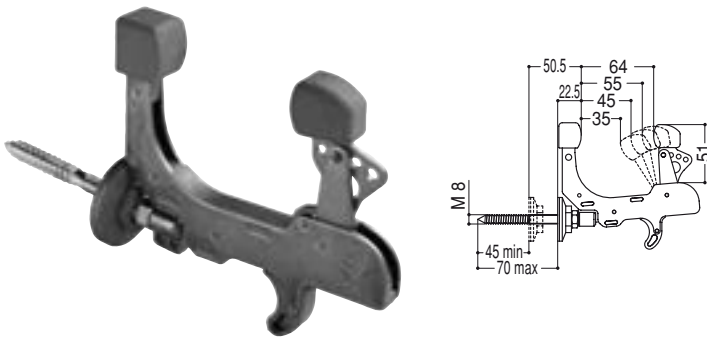
Art. 099992213.0 01 03	DESCRIZIONE DESCRIPTION DESCRIPCIÓN	MATERIALE MATERIAL MATERIALE	SCATOLA BOX CAJA
	<p>Spessore da mm 14,5 per                      SUPER TOP GRILLO                      SUPER MIDI GRILLO                      SUPER MAXI GRILLO</p> <p>14,5 mm shim for                      SUPER TOP GRILLO                      SUPER MIDI GRILLO                      SUPER MAXI GRILLO</p> <p>Espesor 14,5 mm para                      SUPER TOP GRILLO                      SUPER MIDI GRILLO                      SUPER MAXI GRILLO</p>	PA	30 Pz
	<p>Borchia maxi per fermo imposte automatici                      Maxi boss for automatic shutter stopper                      Escudo maxi para retenedor de hoja automático</p>	PA	
	<p>Borchia anti svitamento per                      SUPER TOP GRILLO                      SUPER MIDI GRILLO                      SUPER MAXI GRILLO</p> <p>Untiscrew proof boss for                      SUPER TOP GRILLO                      SUPER MIDI GRILLO                      SUPER MAXI GRILLO</p> <p>Bloqueo fijacion para                      SUPER TOP GRILLO                      SUPER MIDI GRILLO                      SUPER MAXI GRILLO</p>	PA	10 Pz
	<p><b>PEPITO</b> (Brevettato)                      fermo imposta automatico in acciaio inox</p> <p><b>PEPITO</b> (Patented)                      stainless steel automatic shutter lock</p> <p><b>PEPITO</b> (Patentado)                      retenedor de hoja automático en acero inox</p>	ACC INOX	20 Pz

00 neutro neutral neutro	01 nero 9005 black 9005 negro 9005	02 bianco white blanco	03 bianco 1013 white 1013 blanco 1013	04 bianco 9010 white 9010 blanco 9010	05 verde green verde	06 verde 6005 green 6005 verde 6005	07 marrone brown marrone	08 marrone 8017 brown 8017 marrone 8017	09 giallo 1006 yellow 1006 amarillo 1006	10 grigio 7001 grey 7001 gris 7001	13 rosso 3003 red 3003 rojo 3003	14 argento silver plateado	15 bronzo bronze bronce
-----------------------------------	---	---------------------------------	--	--	-------------------------------	--	-----------------------------------	--	---	---	---	-------------------------------------	----------------------------------

Art. 099990009.0 01

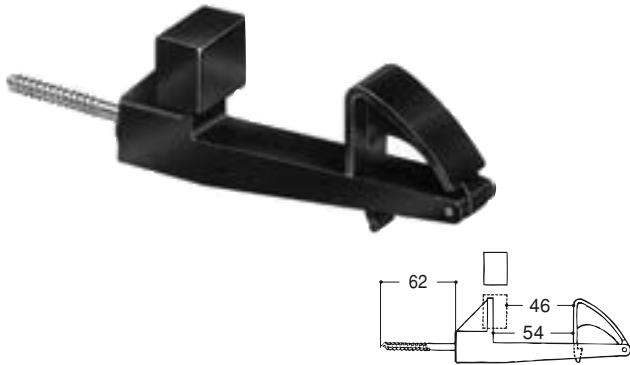

DESCRIZIONE DESCRIPTION DESCRIPCIÓN	MATERIALE MATERIAL MATERIAL	SCATOLA BOX CAJA
<p><b>FARFALLA</b> fermo imposta manuale con vite da mm 70</p> <p><b>FARFALLA</b> manual shutter lock with 70 mm screw</p> <p><b>FARFALLA</b> retenedor de hoja manual con tornillo de 70 mm</p>	PA	200 Pz

Art. 099990099.0 01



<p><b>LIBELLULA</b> fermo imposta manuale con vite da mm 70</p> <p><b>LIBELLULA</b> manual shutter lock with 70 mm screw</p> <p><b>LIBELLULA</b> retenedor de hoja manual con tornillo de 70 mm</p>	PA	40 Pz
---	----	----------

Art. 099990007.0 01



<p><b>CALABRONE</b> fermo imposta manuale con vite da mm 70</p> <p><b>CALABRONE</b> manual shutter lock with 70 mm screw</p> <p><b>CALABRONE</b> retenedor de hoja manual con tornillo de 70 mm</p>	PA	40 Pz
---	----	----------

Art. 099990006.0 01



<p><b>MINI GRILLO</b> fermo imposta automatico terza anta</p> <p><b>MINI GRILLO</b> third leaf automatic shutter lock</p> <p><b>MINI GRILLO</b> retenedor de hoja automático para 3ª hoja</p>	PA	200 Pz
---	----	-----------

16  
 elettro col. nero  
 electrum col. black  
 anodizado col. negro

25  
 marrone 8014  
 brown 8014  
 marrone 8014

26  
 verde 5293  
 gothic 5293  
 verde 5293

37  
 ottone  
 brass  
 ottone

39  
 nero opaco  
 opaque black  
 negro opaco

60  
 verde 5123  
 green 5123  
 verde 5123

68  
 grigio 9006  
 gothic 9006  
 gris 9006

77  
 cromo  
 chrome  
 cromo

MO  
 mogano  
 mahogany  
 caoba

NO  
 noce  
 walnut  
 nogal

RO  
 rovere  
 oak  
 roble

Art. 099992752.0 01

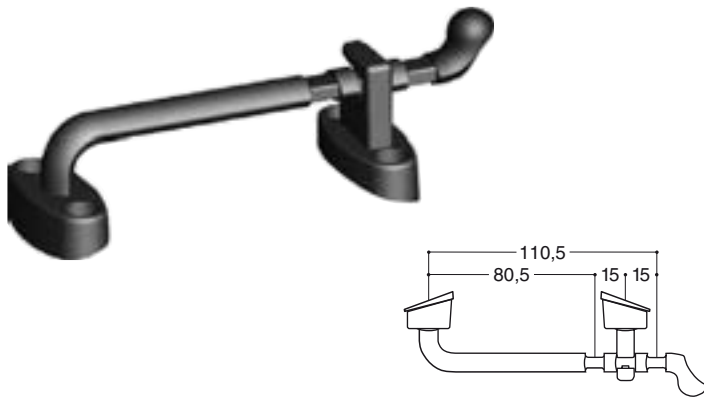

**BRUCO**  
 Socchiudi finestra manuale a due ante con viti brunite  
**BRUCO**  
 manual part shutter for two leaf window with bronzed screws  
**BRUCO**  
 cierra ventana abisagrada 2 hojas manual con tornillos  
 brunidos

DESCRIZIONE DESCRIPTION DESCRIPCIÓN	MATERIALE MATERIAL MATERIALE	SCATOLA BOX CAJA
	PA	200 Pz

Art. 099990005.0 01

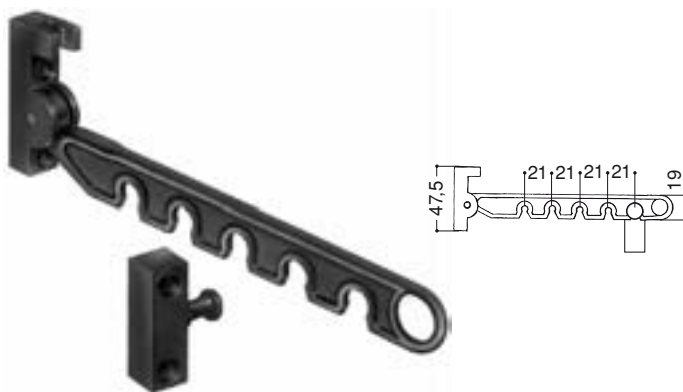

**CICALONE**  
 Socchiudi finestra a una anta  
**CICALONE**  
 part shutter for one leaf window  
**CICALONE**  
 cierra ventana abisagrada 1 hoja

DESCRIZIONE DESCRIPTION DESCRIPCIÓN	MATERIALE MATERIAL MATERIALE	SCATOLA BOX CAJA
	PA	200 Pz

Art. 099992988.0 01

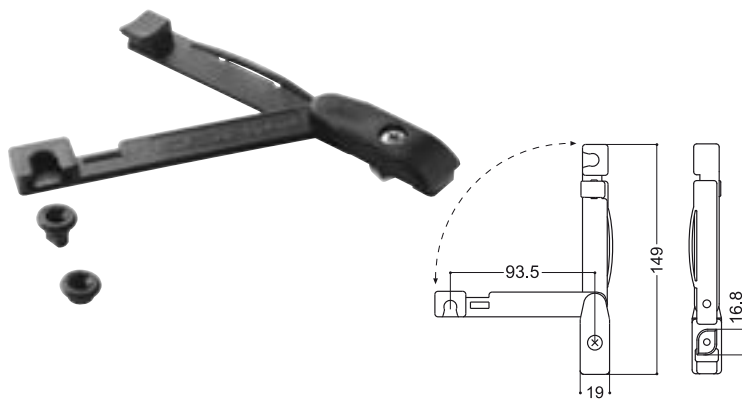

Braccetto a scomparsa socchiudi finestra manuale  
 Hidden arm manual part shutter  
 Brazo oculto cierra ventana manual

DESCRIZIONE DESCRIPTION DESCRIPCIÓN	MATERIALE MATERIAL MATERIALE	SCATOLA BOX CAJA
	PA	100 Pz

Art. 099992898.0 01

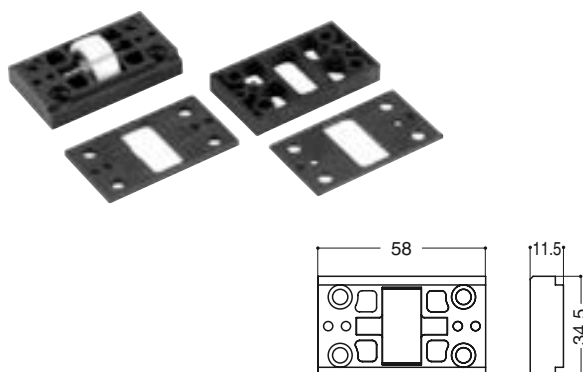

Basamento con rotellina reggi anta (Scacciapensieri)  
 con spessori vari  
 Rotating supporting wheel base plate with different  
 thickness (scacciapensieri)  
 Base con rodamiento para puerta

DESCRIZIONE DESCRIPTION DESCRIPCIÓN	MATERIALE MATERIAL MATERIALE	SCATOLA BOX CAJA
	PA	500 Pz

00  
neutro  
neutral  
neutro

01  
nero 9005  
black 9005  
negro 9005

02  
bianco  
white  
blanco

03  
bianco 1013  
white 1013  
blanco 1013

04  
bianco 9010  
white 9010  
blanco 9010

05  
verde  
green  
verde

06  
verde 6005  
green 6005  
verde 6005

07  
marrone  
brown  
marrone

08  
marrone 8017  
brown 8017  
marrone 8017

09  
giallo 1006  
yellow 1006  
amarillo 1006

10  
grigio 7001  
grey 7001  
gris 7001

13  
rosso 3003  
red 3003  
rojo 3003

14  
argento  
silver  
plateado

15  
bronzo  
bronze  
bronce

Art. 099990068.0 01

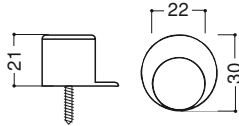

DESCRIZIONE DESCRIPTION DESCRIPCIÓN	MATERIALE MATERIAL MATERIAL	SCATOLA BOX CAJA
Cilindro di battuta regolabile (eccentrico) Fixed ledge cylinder (eccentric) Tope regulable para persiana mallorquina	PA	1.000 Pz

Art. 099990032.0 01

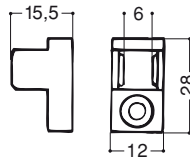

Blocca astina Ø 6 per persiana a sporgere Block rod Ø 6 for shutter with top-hung hinges Sistema de bloqueo para eje de Ø 6 para persiana	PA	5.000 Pz
---	----	-------------

Art. 099990013.0 01

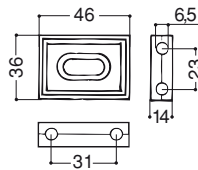

Fermapaletto guida asta 40 - 50 40 - 50 pallet guide rod Gula eje 40 - 50	PA	1.000 Pz
---	----	-------------

Art. 099990098.0 01

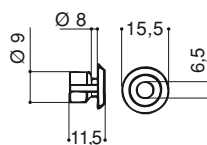

Boccola di riscontro per astina Ø 6 Striker bushing for Ø 6 rod Boca para terminal de Ø 6	PA	1.000 Pz
---	----	-------------

16  
 eletto col. nero  
 electrum col. black  
 anodizado col. negro

25  
 marrone 8014  
 brown 8014  
 marrone 8014

26  
 verde 5293  
 gothic 5293  
 verde 5293

37  
 ottone  
 brass  
 ottone

39  
 nero opaco  
 opaque black  
 negro opaco

60  
 verde 5123  
 green 5123  
 verde 5123

68  
 grigio 9006  
 gothic 9006  
 gris 9006

77  
 cromo  
 chrome  
 cromo

MO  
 mogano  
 mahogany  
 caoba

NO  
 noce  
 walnut  
 nogal

RO  
 rovere  
 oak  
 roble

Art. 099991638.0 01

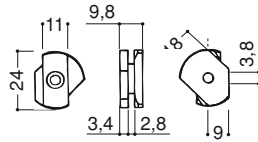

DESCRIZIONE  
 DESCRIPTION  
 DESCRIPCIÓN

Blocchetto di assemblaggio per profili legno / alluminio  
 (utilizzare chiave cod. 1128)

Assembly Block for wood/aluminium profiles  
 (to use key cod. 1128)

Bloqueo de ensamblaje para perfiles madera / aluminio  
 (usar llave cod. 1128)

MATERIALE MATERIAL MATERIALE	SCATOLA BOX CAJA
PA	5.000 Pz

Art. 099991562.0 00

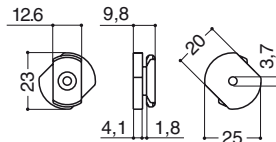

Blocchetto di assemblaggio per profili legno / alluminio  
 (utilizzare chiave cod. 2896)

Assembly Block for wood/aluminium profiles  
 (to use key cod. 2896 )

Bloqueo de ensamblaje para perfiles madera / aluminio  
 (usar llave cod. 2896)

PA	5.000 Pz
----	-------------

Art. 099992191.0 01

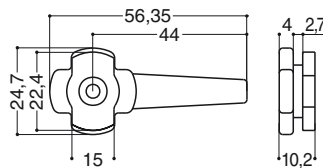

Blocchetto di assemblaggio per profili legno / alluminio  
 ALL.CO - WOOD

Assembly Block for wood/aluminium profiles  
 ALL.CO - WOOD

Bloqueo de ensamblaje para perfiles madera / aluminio  
 ALL.CO - WOOD

PA	5.000 Pz
----	-------------

Art. 099990012.0 01

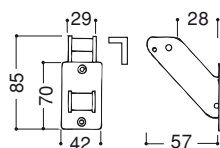

Rullo passa cinghia  
 UNIBLOCK con piastrino e viti

Transmission belt  
 UNIBLOCK with plate and screws

Pasa cinta UNIBLOCK con placa y tornillos

PA	200 Pz
----	-----------

00  
neutro  
neutral  
neutro

01  
nero 9005  
black 9005  
negro 9005

02  
bianco  
white  
blanco

03  
bianco 1013  
white 1013  
blanco 1013

04  
bianco 9010  
white 9010  
blanco 9010

05  
verde  
green  
verde

06  
verde 6005  
green 6005  
verde 6005

07  
marrone  
brown  
marrone

08  
marrone 8017  
brown 8017  
marrone 8017

09  
giallo 1006  
yellow 1006  
amarillo 1006

10  
grigio 7001  
grey 7001  
gris 7001

13  
rosso 3003  
red 3003  
rojo 3003

14  
argento  
silver  
plateado

15  
bronzo  
bronze  
bronce

Art. 099990685.0

01

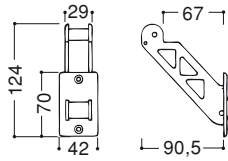

DESCRIZIONE DESCRIPTION DESCRIPCIÓN	APPLICAZIONE APPLICATION APLICACIÓN	MATERIALE MATERIAL MATERIAL	SCATOLA BOX CAJA
Rullo passa cinghia UNIBLOCK prolungato Extended transmission belt UNIBLOCK Pasa cinta UNIBLOCK extendida	EKIP - DOMAL - ALL.CO R 40 - OCMA - EURO	PA	300 Pz

Art. 099992058.3

01

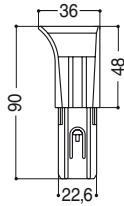

Invito tapparella dx - sx Right - Left shutter guide Gula dch - izd de persiana	DOMAL SPIDER L 48/31145	PA	400 coppie pairs parejas
---	----------------------------	----	-----------------------------------

Art. 099992967.0

01

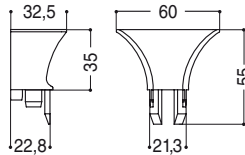

Invito tapparella Shutter guide Gula de persiana	GRIFTEL PONS 10679	PA	1.000 Pz
--	--------------------	----	-------------

Art. 099992977.0

01

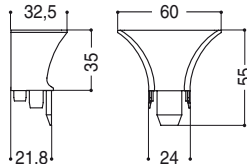

Invito tapparella Shutter guide Gula de persiana	GRIFTEL PONS 60869	PA	1.000 Pz
--	--------------------	----	-------------

Art. 699992614.0

01

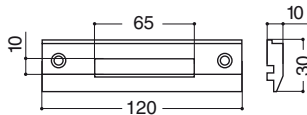

Contropiastra per serratura Profiles counterplate Contraplaca	R40	PA	
---	-----	----	--

Art. 099990052.0

01

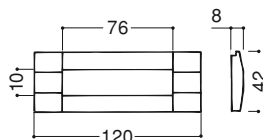

Contropiastra Counterplate Contraplaca	NC - GR 9	PA	500 Pz
--	-----------	----	-----------

16  
 eletto col. nero  
 electrum col. black  
 anodizado col. negro

25  
 marrone 8014  
 brown 8014  
 marrone 8014

26  
 verde 5293  
 gothic 5293  
 verde 5293

37  
 ottone  
 brass  
 ottone

39  
 nero opaco  
 opaque black  
 negro opaco

60  
 verde 5123  
 green 5123  
 verde 5123







68  
 grigio 9006  
 gothic 9006  
 gris 9006

77  
 cromo  
 chrome  
 cromo

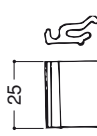
MO  
 mogano  
 mahogany  
 caoba

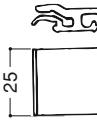
NO  
 noce  
 walnut  
 nogal

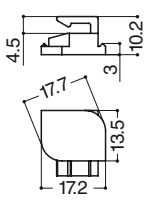
RO  
 rovere  
 oak  
 roble

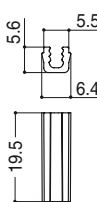
Art.	DESCRIZIONE DESCRIPTION DESCRIPCIÓN	APPLICAZIONE APPLICATION APLICACIÓN	MATERIALE MATERIAL MATERIAL	SCATOLA BOX CAJA
<b>Art. 099990127.0</b> 00  	Clips ferma vetro Window frame clip Clip junquillo	Serie series serie ALPHA 445 - GLOBO	POM	5.000 Pz
<b>Art. 099991110.0</b> 00  	Clips ferma vetro Window frame clip Clip junquillo	Serie series serie SISTEMA 1 TRAFILERIE EMILIANE	POM	2.000 Pz
<b>Art. 099992838.0</b> 00  	Clips ferma vetro Window frame clip Clip junquillo	ALFIL 45 DOMAL BREAK 70S	POM	6.000 Pz
<b>Art. 099990290.0</b> 00  	Clips coprifilo Coverwire clips Clip tapajuntas	EXPORT 50 - TRIALL.CO	POM	
<b>Art.</b>				
<b>Art.</b>				



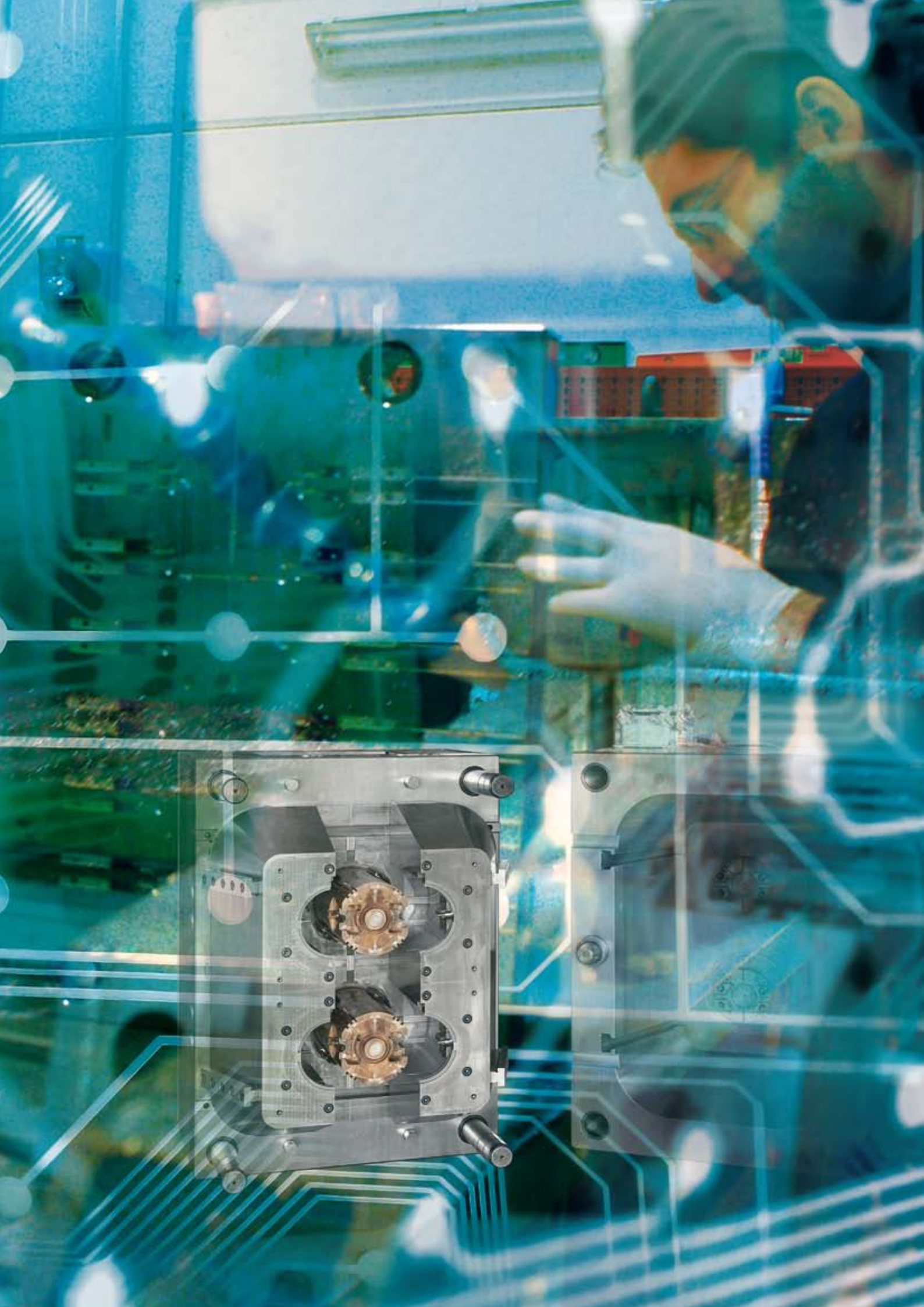

# TAPPI PER PROFILATI



PLUGS  
FOR PROFILES

TAPONES  
PARA PERFILES

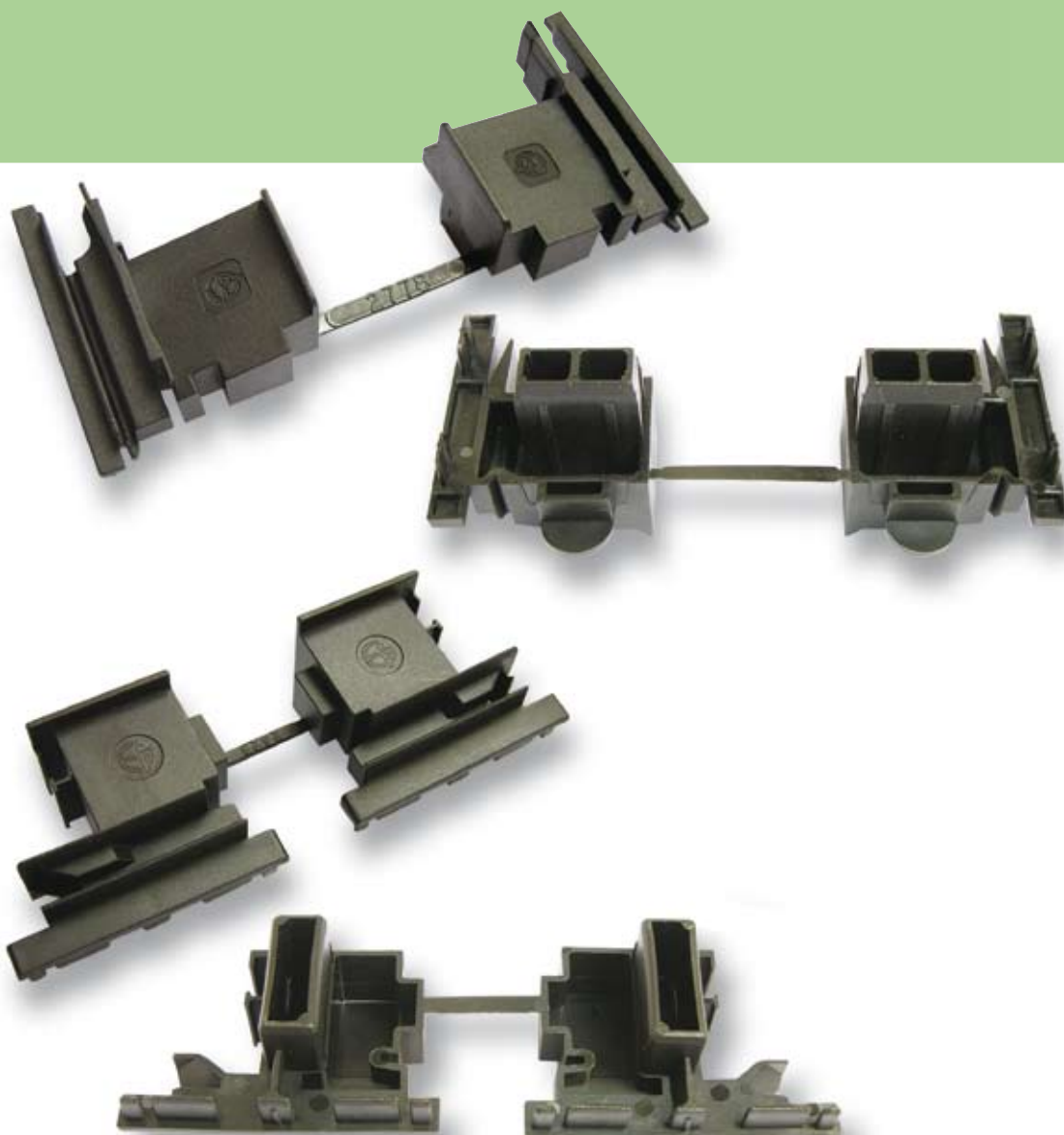

00

neutro  
neutral  
neutro

01

nero 9005  
black 9005  
negro 9005

02

bianco  
white  
blanco

03

bianco 1013  
white 1013  
blanco 1013

04

bianco 9010  
white 9010  
blanco 9010

05

verde  
green  
verde

06

verde 6005  
green 6005  
verde 6005

07

marrone  
brown  
marrone

08

marrone 8017  
brown 8017  
marrone 8017

09

giallo 1006  
yellow 1006  
amarillo 1006

10

grigio 7001  
grey 7001  
gris 7001

13

rosso 3003  
red 3003  
rojo 3003

14

argento  
silver  
plateado

15

bronzo  
bronze  
bronce

Art. 099990026.0 01

DESCRIZIONE  
DESCRIPTION  
DESCRIPCIÓN

Tappo terminale per profili persiana

Terminal plug for shutter profiles

Tapón terminal para perfiles persiana

APPLICAZIONE  
APPLICATION  
APLICACIÓN

R 40 / 900399  
ALL.CO 5

MATERIALE  
MATERIAL

PP

SCATOLA  
BOX  
CAJA

100  
Pz.

Art. 099990023.0 01



Tappo terminale per profili persiana

Terminal plug for shutter profiles

Tapón terminal para perfiles persiana

R 40 / 900396  
ALL.CO / 1494

PP

1.000  
Pz

Art. 099991964.3 01



Tappi terminali dx - sx per profilo persiana

Right - left terminal plugs for shutter profile

Tapones terminal dch-izd para perfil persiana

R 40 / 800365

PP

750  
coppie  
pairs  
parejas

Art. 099991965.3 01



Tappi terminali dx - sx per profilo persiana

Right - left terminal plugs for shutter profile

Tapones terminal dch-izd para perfil persiana

R 40 / 900250 - 900658

PP

500  
coppie  
pairs  
parejas

Art. 099992184.3 01



Tappo terminale dx - sx per profili persiana

Right - left terminal plugs for shutter profiles

Tapón terminal dch-izd para perfil persiana

R 40 / 800577 - 800645

PP

500  
coppie  
pairs  
parejas

Art. 099990054.0 01



Tappo terminale per profili persiana alla genovese

Terminal plug for "genovese" shutter profile

Tapón terminal dch-izd para perfiles persiana genovesas

FB 12 - METRA - ALL.CO

PP

2.000  
Pz

16

eletto col. nero  
electrum col. black  
anodizado col. negro

25

marrone 8014  
brown 8014  
marrone 8014

26

verde 5293  
gothic 5293  
verde 5293

37

ottone  
brass  
ottone

39

nero opaco  
opaque black  
negro opaco

60

verde 5123  
green 5123  
verde 5123

68

grigio 9006  
gothic 9006  
gris 9006

77

cromo  
chrome  
cromo

MO

mogano  
mahogany  
caoba

NO





noce  
walnut  
nogal

RO

rovere  
oak  
roble

Art. 099990063.0	01	DESCRIZIONE DESCRIPTION DESCRIPCIÓN	APPLICAZIONE APPLICATION APLICACIÓN	MATERIALE MATERIAL MATERIAL	SCATOLA BOX CAJA
		<p>Tappo terminale per profili persiana alla genovese maggiorati</p> <p>Terminal plug for extended genovese shutter profile</p> <p>Tapón terminal para perfiles persiana</p>	FB 12 - METRA - ALL.CO - GLOBAL	PP	1.000 Pz
		<p>Tappi terminali dx - sx per profilo persiana</p> <p>Right - left terminal plugs for shutter profile</p> <p>Tapones terminal derecha -izquierda para perfil persiana</p>	METRA - R 3553	PP	500 coppie pairs parejas
		<p>Tappo terminale per profili persiana</p> <p>Terminal plug for shutter profile</p> <p>Tapón terminal para perfiles persiana</p>	EKIP 40 / 8146 - METRA	PP	1.000 Pz
		<p>Tappo terminale per profilo persiana camera NACO</p> <p>Terminal plug for NACO camera shutter profile</p> <p>Tapón terminal para perfil persiana cámara NACO</p>	EKIP 40 / 10211 maggiorato - extended - sobredimensionado NC 40 maggiorato - extended sobredimensionado	PP	1.000 Pz
		<p>Tappi terminali dx - sx per profilo persiana</p> <p>Right - left terminal plugs for shutter profile</p> <p>Tapones terminal dch-izd para perfil persiana</p>	EKIP ZK 13737 / 38	PP	800 coppie pairs parejas
		<p>Tappi terminali dx - sx per profilo persiana</p> <p>Right - left terminal plugs for shutter profile</p> <p>Tapones terminal dch-izd para perfil persiana</p>	EKIP ZK 13739 / 40	PP	2.000 coppie pairs parejas







00	01	02	03	04	05	06	07	08	09	10	13	14	15
neutro neutral neutro	nero 9005 black 9005 negro 9005	bianco white blanco	bianco 1013 white 1013 blanco 1013	bianco 9010 white 9010 blanco 9010	verde green verde	verde 6005 green 6005 verde 6005	marone brown marone	marone 8017 brown 8017 marone 8017	giallo 1006 yellow 1006 amarillo 1006	grigio 7001 grey 7001 gris 7001	rosso 3003 red 3003 rojo 3003	argento silver plateado	bronzo bronze bronce

Art. 099992123.3 01	DESCRIZIONE DESCRIPTION DESCRIPCIÓN	APPLICAZIONE APPLICATION APLICACIÓN	MATERIALE MATERIAL MATERIAL	SCATOLA BOX CAJA
	Tappi terminali dx - sx per profilo persiana Right - left terminal plugs for shutter profile Tapones terminal dch-izd para perfil persiana	EKIP 40 ZK 10211 / ZK 9452	PP	500 coppie pairs parejas
	Tappi terminali dx - sx per profili persiana Right - left terminal plugs for shutter profile Tapones terminal dch-izd para perfil persiana	EKIP ZK 11286	PP	500 coppie pairs parejas
	Tappi terminali dx - sx per profili persiana Right - left terminal plugs for shutter profile Tapones terminal dch-izd para perfil persiana	EKIP ZK 11645	PP	500 coppie pairs parejas
	Tappo terminale per profili persiana Terminal plug for shutter profile Tapón terminal para perfiles persiana	ALPHA 445 ALL.CO 1488/1569	PP	500 Pz
	Tappo terminale per profilo persiana Terminal plug for shutter profile Tapón terminal para perfiles persiana	NC 40	PA	1.000 Pz
	Tappo terminale per profilo persiana Terminal plug for shutter profile Tapón terminal para perfiles persiana	NC 40 maggiorato extended sobredimensionado	PP	500 Pz

- 16**  
eletto col. nero  
electrum col. black  
anodizado col. negro
- 25**  
marrone 8014  
brown 8014  
marrone 8014
- 26**  
verde 5293  
gothic 5293  
verde 5293
- 37**  
ottone  
brass  
ottone
- 39**  
nero opaco  
opaque black  
negro opaco
- 60**  
verde 5123  
green 5123  
verde 5123
- 68**  
grigio 9006  
gothic 9006  
gris 9006
- 77**  
cromo  
chrome  
cromo
- MO**  
mogano  
mahogany  
caoba
- NO**  
noce  
walnut  
nogal
- RO**  
rovere  
oak  
roble

	DESCRIZIONE DESCRIPTION DESCRIPCIÓN	APPLICAZIONE APPLICATION APLICACIÓN	MATERIALE MATERIAL MATERIAL	SCATOLA BOX CAJA
<b>Art. 099990861.0</b> 01 <input type="text"/> <input type="text"/> <input type="text"/> <input type="text"/> <input type="text"/> <input type="text"/> <input type="text"/> <input type="text"/> <input type="text"/> <input type="text"/> <input type="text"/> <input type="text"/> <input type="text"/> <input type="text"/> <input type="text"/> <input type="text"/> <input type="text"/> 	Tappo terminale per profili persiana movimento DOMAL Terminal plug for DOMAL movement shutter profile Tapón terminal dch-izd para perfil persiana movimiento DOMAL	R 40 - ALL.CO ALPHA 445 - EKIP 40	PP	500 Pz
<b>Art. 099990699.3</b> 01 <input type="text"/> <input type="text"/> <input type="text"/> <input type="text"/> <input type="text"/> <input type="text"/> <input type="text"/> <input type="text"/> <input type="text"/> <input type="text"/> <input type="text"/> <input type="text"/> <input type="text"/> <input type="text"/> <input type="text"/> <input type="text"/> <input type="text"/> 	Tappi terminali dx - sx per profilo persiana Right - left terminal plugs for shutter profile Tapones terminal dch-izd para perfil persiana	DOMAL GELOSIA / 24457	PP	500 coppie pairs parejas
<b>Art. 099990860.3</b> 01 <input type="text"/> <input type="text"/> <input type="text"/> <input type="text"/> <input type="text"/> <input type="text"/> <input type="text"/> <input type="text"/> <input type="text"/> <input type="text"/> <input type="text"/> <input type="text"/> <input type="text"/> <input type="text"/> <input type="text"/> <input type="text"/> <input type="text"/> 	Tappi terminali dx - sx per profilo persiana Right - left terminal plugs for shutter profile Tapones terminal dch-izd para perfil persiana	DOMAL GELOSIA / 19663	PP	500 coppie pairs parejas
<b>Art. 099990695.3</b> 01 <input type="text"/> <input type="text"/> <input type="text"/> <input type="text"/> <input type="text"/> <input type="text"/> <input type="text"/> <input type="text"/> <input type="text"/> <input type="text"/> <input type="text"/> <input type="text"/> <input type="text"/> <input type="text"/> <input type="text"/> <input type="text"/> <input type="text"/> 	Tappi terminali dx - sx per profilo persiana Right - left terminal plugs for shutter profile Tapones terminal dch-izd para perfil persiana	DOMAL UNIVERSAL 55 / 21662	PP	500 coppie pairs parejas
<b>Art. 099991898.3</b> 01 <input type="text"/> <input type="text"/> <input type="text"/> <input type="text"/> <input type="text"/> <input type="text"/> <input type="text"/> <input type="text"/> <input type="text"/> <input type="text"/> <input type="text"/> <input type="text"/> <input type="text"/> <input type="text"/> <input type="text"/> <input type="text"/> <input type="text"/> 	Tappi terminali dx - sx per profili persiana Right - left terminal plugs for shutter profile Tapones terminal dch-izd para perfil persiana	UNIVERSAL 55 DOMAL GELOSIA 26211/26212 19724/19741	PP	1.000 coppie pairs parejas
<b>Art. 099991899.3</b> 01 <input type="text"/> <input type="text"/> <input type="text"/> <input type="text"/> <input type="text"/> <input type="text"/> <input type="text"/> <input type="text"/> <input type="text"/> <input type="text"/> <input type="text"/> <input type="text"/> <input type="text"/> <input type="text"/> <input type="text"/> <input type="text"/> <input type="text"/> 	Tappi terminali dx - sx per profili persiana Right - left terminal plugs for shutter profile Tapones terminal dch-izd para perfil persiana	UNIVERSAL 55 DOMAL 40 / 21688	PP	1.000 coppie pairs parejas

00	01	02	03	04	05	06	07	08	09	10	13	14	15
neutro neutral neutro	nero 9005 black 9005 negro 9005	bianco white blanco	bianco 1013 white 1013 blanco 1013	bianco 9010 white 9010 blanco 9010	verde green verde	verde 6005 green 6005 verde 6005	marone brown marone	marone 8017 brown 8017 marone 8017	giallo 1006 yellow 1006 amarillo 1006	grigio 7001 grey 7001 gris 7001	rosso 3003 red 3003 rojo 3003	argento silver plateado	bronzo bronze bronce

Art. 099992110.3 01	DESCRIZIONE DESCRIPTION DESCRIPCIÓN	APPLICAZIONE APPLICATION APLICACIÓN	MATERIALE MATERIAL	SCATOLA BOX CAJA
	Tappi terminali dx - sx per profili persiana Right - left terminal plugs for shutter profile Tapones terminal dch-izd para perfil persiana	DOMAL 27359	PA	500 coppie pairs parejas
	Tappi terminali dx - sx per profili persiana Right - left terminal plugs for shutter profile Tapones terminal dch-izd para perfil persiana	DOMAL 27362	PA	500 coppie pairs parejas
	Tappi terminali dx - sx per profili persiana Right - left terminal plugs for shutter profile Tapones terminal dch-izd para perfil persiana	DOMAL SUNNY 27394 - 27539	PP	500 coppie pairs parejas
	Tappi terminali dx - sx Right - left terminal plugs Tapones terminal dch-izd	EQUIPE INVERSIONE	PA	500 coppie pairs parejas
	Tappi terminali dx - sx per profilo anta persiana rustica Right - left terminal plugs for country-style shutter profile Tapones terminal dch-izd para perfil persiana ante persiana rustica	EQUIPE	PA	750 coppie pairs parejas
	Tappi terminali dx - sx per profilo anta persiana Right - left terminal plugs for serial shutter profile Tapones terminal dch-izd para perfil persiana ante persiana	EQUIPE 8000	PA	500 coppie pairs parejas

- 16**  
eletto col. nero  
electrum col. black  
anodizado col. negro
- 25**  
marrone 8014  
brown 8014  
marrone 8014
- 26**  
verde 5293  
gothic 5293  
verde 5293
- 37**  
ottone  
brass  
ottone
- 39**  
nero opaco  
opaque black  
negro opaco
- 60**  
verde 5123  
green 5123  
verde 5123
- 68**  
grigio 9006  
gothic 9006  
gris 9006
- 77**  
cromo  
chrome  
cromo
- MO**  
mogano  
mahogany  
caoba
- NO**  
noce  
walnut  
nogal
- RO**  
rovere  
oak  
roble

	DESCRIZIONE DESCRIPTION DESCRIPCIÓN	APPLICAZIONE APPLICATION APLICACION	MATERIALE MATERIAL MATERIAL	SCATOLA BOX CAJA																							
<b>Art. 099991415.3</b> 01 <table border="1" style="display: inline-table; border-collapse: collapse;"><tr><td style="width: 15px;"> </td><td style="width: 15px;"> </td><td style="width: 15px;"> </td><td style="width: 15px;"> </td><td style="width: 15px;"> </td><td style="width: 15px;"> </td><td style="width: 15px;"> </td><td style="width: 15px;"> </td><td style="width: 15px;"> </td><td style="width: 15px;"> </td><td style="width: 15px;"> </td><td style="width: 15px;"> </td><td style="width: 15px;"> </td><td style="width: 15px;"> </td><td style="width: 15px;"> </td><td style="width: 15px;"> </td><td style="width: 15px;"> </td><td style="width: 15px;"> </td><td style="width: 15px;"> </td><td style="width: 15px;"> </td><td style="width: 15px;"> </td></tr></table> 																						Tappi terminali dx - sx per profili persiana Right - left terminal plugs for shutter profile Tapones terminal dch-izd para perfil persiana	EKLI - ALL.CO 5 VZ 3608	PP	500 coppie pairs parejas		
<b>Art. 099991897.3</b> 01 <table border="1" style="display: inline-table; border-collapse: collapse;"><tr><td style="width: 15px;"> </td><td style="width: 15px;"> </td><td style="width: 15px;"> </td><td style="width: 15px;"> </td><td style="width: 15px;"> </td><td style="width: 15px;"> </td><td style="width: 15px;"> </td><td style="width: 15px;"> </td><td style="width: 15px;"> </td><td style="width: 15px;"> </td><td style="width: 15px;"> </td><td style="width: 15px;"> </td><td style="width: 15px;"> </td><td style="width: 15px;"> </td><td style="width: 15px;"> </td><td style="width: 15px;"> </td><td style="width: 15px;"> </td><td style="width: 15px;"> </td><td style="width: 15px;"> </td><td style="width: 15px;"> </td><td style="width: 15px;"> </td><td style="width: 15px;"> </td><td style="width: 15px;"> </td></tr></table> 																								Tappi terminali dx - sx per profili persiana Right - left terminal plugs for shutter profile Tapones terminal dch-izd para perfil persiana	EKLI - ALL.CO P4 VZ 0747	PP	600 coppie pairs parejas
<b>Art. 099992198.3</b> 01 <table border="1" style="display: inline-table; border-collapse: collapse;"><tr><td style="width: 15px;"> </td><td style="width: 15px;"> </td><td style="width: 15px;"> </td><td style="width: 15px;"> </td><td style="width: 15px;"> </td><td style="width: 15px;"> </td><td style="width: 15px;"> </td><td style="width: 15px;"> </td><td style="width: 15px;"> </td><td style="width: 15px;"> </td><td style="width: 15px;"> </td><td style="width: 15px;"> </td><td style="width: 15px;"> </td><td style="width: 15px;"> </td><td style="width: 15px;"> </td><td style="width: 15px;"> </td><td style="width: 15px;"> </td><td style="width: 15px;"> </td><td style="width: 15px;"> </td><td style="width: 15px;"> </td><td style="width: 15px;"> </td><td style="width: 15px;"> </td><td style="width: 15px;"> </td></tr></table> 																								Tappi terminali dx - sx per profili persiana Right - left terminal plugs for shutter profile Tapones terminal dch-izd para perfil persiana	ALL.CO VZ 4366	PP	500 coppie pairs parejas
<b>Art. 099992161.3</b> 01 <table border="1" style="display: inline-table; border-collapse: collapse;"><tr><td style="width: 15px;"> </td><td style="width: 15px;"> </td><td style="width: 15px;"> </td><td style="width: 15px;"> </td><td style="width: 15px;"> </td><td style="width: 15px;"> </td><td style="width: 15px;"> </td><td style="width: 15px;"> </td><td style="width: 15px;"> </td><td style="width: 15px;"> </td><td style="width: 15px;"> </td><td style="width: 15px;"> </td><td style="width: 15px;"> </td><td style="width: 15px;"> </td><td style="width: 15px;"> </td><td style="width: 15px;"> </td><td style="width: 15px;"> </td><td style="width: 15px;"> </td><td style="width: 15px;"> </td><td style="width: 15px;"> </td><td style="width: 15px;"> </td><td style="width: 15px;"> </td><td style="width: 15px;"> </td></tr></table> 																								Tappi terminali dx - sx per profili persiana Right - left terminal plugs for shutter profile Tapones terminal dch-izd para perfil persiana	ALL.CO VZ 4303	PP	500 coppie pairs parejas
<b>Art. 099992113.3</b> 01 <table border="1" style="display: inline-table; border-collapse: collapse;"><tr><td style="width: 15px;"> </td><td style="width: 15px;"> </td><td style="width: 15px;"> </td><td style="width: 15px;"> </td><td style="width: 15px;"> </td><td style="width: 15px;"> </td><td style="width: 15px;"> </td><td style="width: 15px;"> </td><td style="width: 15px;"> </td><td style="width: 15px;"> </td><td style="width: 15px;"> </td><td style="width: 15px;"> </td><td style="width: 15px;"> </td><td style="width: 15px;"> </td><td style="width: 15px;"> </td><td style="width: 15px;"> </td><td style="width: 15px;"> </td><td style="width: 15px;"> </td><td style="width: 15px;"> </td><td style="width: 15px;"> </td><td style="width: 15px;"> </td><td style="width: 15px;"> </td><td style="width: 15px;"> </td></tr></table> 																								Tappi terminali dx - sx per profili persiana Right - left terminal plugs for shutter profile Tapones terminal dch-izd para perfil persiana	ALL.CO 5 VZ 1481 / VZ 3606	PP	500 coppie pairs parejas
<b>Art. 099992114.3</b> 01 <table border="1" style="display: inline-table; border-collapse: collapse;"><tr><td style="width: 15px;"> </td><td style="width: 15px;"> </td><td style="width: 15px;"> </td><td style="width: 15px;"> </td><td style="width: 15px;"> </td><td style="width: 15px;"> </td><td style="width: 15px;"> </td><td style="width: 15px;"> </td><td style="width: 15px;"> </td><td style="width: 15px;"> </td><td style="width: 15px;"> </td><td style="width: 15px;"> </td><td style="width: 15px;"> </td><td style="width: 15px;"> </td><td style="width: 15px;"> </td><td style="width: 15px;"> </td><td style="width: 15px;"> </td><td style="width: 15px;"> </td><td style="width: 15px;"> </td><td style="width: 15px;"> </td><td style="width: 15px;"> </td><td style="width: 15px;"> </td><td style="width: 15px;"> </td></tr></table> 																								Tappi terminali dx - sx per profili persiana Right - left terminal plugs for shutter profile Tapones terminal dch-izd para perfil persiana	ALL.CO P4 VZ 0635 / VZ 0749	PP	500 coppie pairs parejas



00	01	02	03	04	05	06	07	08	09	10	13	14	15
neutro neutral neutro	nero 9005 black 9005 negro 9005	bianco white blanco	bianco 1013 white 1013 blanco 1013	bianco 9010 white 9010 blanco 9010	verde green verde	verde 6005 green 6005 verde 6005	marone brown marone	marone 8017 brown 8017 marone 8017	giallo 1006 yellow 1006 amarillo 1006	grigio 7001 grey 7001 gris 7001	rosso 3003 red 3003 rojo 3003	argento silver plateado	bronzo bronze bronce





Art. 099992139.3 01	DESCRIZIONE DESCRIPTION DESCRIPCIÓN	APPLICAZIONE APPLICATION APLICACIÓN	MATERIALE MATERIAL MATERIAL	SCATOLA BOX CAJA
	Tappi terminali dx - sx per profili persiana Right - left terminal plugs for shutter profile Tapones terminal dch-izd para perfil persiana	ALL.CO - CE 024	PP	500 coppie pairs parejas
	Tappi terminali dx - sx per profili persiana Right - left terminal plugs for shutter profile Tapones terminal dch-izd para perfil persiana	ALL.CO - CE 003	PP	500 coppie pairs parejas
	Tappi terminali dx - sx per profilo persiana Right - left terminal plugs for shutter profile Tapones terminal dch-izd para perfil persiana	EKU 53 T.E.S. 5680	PP	1.000 coppie pairs parejas
	Tappi terminali dx - sx per profilo persiana Right - left terminal plugs for shutter profile Tapones terminal dch-izd para perfil persiana	EKU 53 T.E.S. 4263	PP	1.000 coppie pairs parejas
	Tappi terminali dx - sx Right - left terminal plugs Tapones terminal dch-izd	EKU 45 T.E.S. 17675	PA	100 coppie pairs parejas
	Tappi terminali dx - sx Right - left terminal plugs Tapones terminal dch-izd	EKU 45 T.E.S. 17677 / 17678 ante - leaf - hoja	PA	50 coppie pairs parejas

Art. 099991434.3 01	DESCRIZIONE DESCRIPTION DESCRIPCIÓN	APPLICAZIONE APPLICATION APLICACIÓN	MATERIALE MATERIAL MATERIAL	SCATOLA BOX CAJA
	Tappi terminali dx - sx Right - left terminal plugs Tapones terminal dch-izd	INDINVEST serie - series - serie GOLD 400 / 40109 - 40073 - 40074	PP	500 coppie pairs parejas
	Tappi terminali dx - sx Right - left terminal plugs Tapones terminal dch-izd	INDINVEST 40075 / 40134	PP	500 coppie pairs parejas
	Tappi terminali dx - sx Right - left terminal plugs Tapones terminal dch-izd	INDINVEST 40136	PP	500 coppie pairs parejas
	Tappi terminali dx - sx per profilo persiana movimen- to METALTECNICA Right - left terminal plug for METALTECNICA movement shutter profile Tapones terminal dch-izd para perfil persiana movimiento METALTECNICA		PP	500 coppie pairs parejas
	Tappi terminali dx - sx Right - left terminal plugs Tapones terminal dch-izd	ALL.CO P4 VZ 0785 / VZ 0755D	PP	500 coppie pairs parejas
	Coprigocciolatoio Drip cover Tapa vierteaguas		PP	500 Pz

00	01	02	03	04	05	06	07	08	09	10	13	14	15
neutro neutral neutro	nero 9005 black 9005 negro 9005	bianco white blanco	bianco 1013 white 1013 blanco 1013	bianco 9010 white 9010 blanco 9010	verde green verde	verde 6005 green 6005 verde 6005	marone brown marone	marone 8017 brown 8017 marone 8017	giallo 1006 yellow 1006 amarillo 1006	grigio 7001 grey 7001 gris 7001	rosso 3003 red 3003 rojo 3003	argento silver plateado	bronzo bronze bronce

Art. 099992844.0 01	DESCRIZIONE DESCRIPTION DESCRIPCIÓN	APPLICAZIONE APPLICATION APLICACIÓN	MATERIALE MATERIAL MATERIAL	SCATOLA BOX CAJA
	Cappetta drenaggio Drainage cap Tapa vierteaguas	DOMAL 40 - BREAK - STOPPER - ALL.CO 5 - P4 EXPORT 40 / 50 / 60	PP	1.000 Pz.
	Cappetta drenaggio Drainage cap for profiles Tapa vierteaguas	R40 / 50 / 50TT EKIP 40 / 50 / 60TT	PP	
	Cappetta drenaggio per asola mm 31x6 Drainage cap for 31x6 mm slot Tapa vierteaguas para orificio orbicular 31x6 mm		PA	2.000 Pz
	Cappetta drenaggio (fori Ø4 - interasse 48) Drainage cap (holes Ø4 - distance 48) Tapa vierteaguas (orificios Ø4 distancia entre ejes 48)		PA	2.000 Pz
	Tappi dx - sx per profilo persiana Right - left terminal plugs for shutter profile Tapones terminal dch-izd para perfil persiana	ALL.CO VZ 3466	PA	100 coppie pairs parejas
	Tappo per ovalina 10 x 50 Plug for 10x50 oval profile Tapón para ovalina 10x50		PA	500 Pz

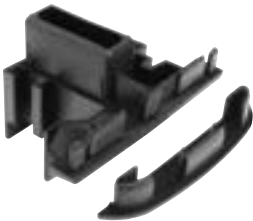
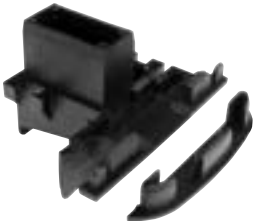
- 16  
eletto col. nero  
electrum col. black  
anodizado col. negro
- 25  
marrone 8014  
brown 8014  
marrone 8014
- 26  
verde 5293  
gothic 5293  
verde 5293
- 37  
ottone  
brass  
ottone
- 39  
nero opaco  
opaque black  
negro opaco
- 60  
verde 5123  
green 5123  
verde 5123
- 68  
grigio 9006  
gothic 9006  
gris 9006
- 77  
cromo  
chrome  
cromo
- MO  
mogano  
mahogany  
caoba
- NO  
noce  
walnut  
nogal
- RO  
rovere  
oak  
roble

	DESCRIZIONE DESCRIPTION DESCRIPCIÓN	APPLICAZIONE APPLICATION APLICACIÓN	MATERIALE MATERIAL MATERIAL	SCATOLA BOX CAJA
<b>Art. 099992849.0</b> 01 <input type="text"/> <input type="text"/> <input type="text"/> <input type="text"/> <input type="text"/> <input type="text"/> <input type="text"/> <input type="text"/> <input type="text"/> <input type="text"/> <input type="text"/> <input type="text"/> <input type="text"/> <input type="text"/> <input type="text"/> <input type="text"/> <input type="text"/> <input type="text"/> <input type="text"/> <input type="text"/> <input type="text"/> 	Tappo Plug Tapón perfil pasamano	ETNALL ET 4322 G 40 / G2019 ATLANTIS AZ 2109	PA	500 Pz
<b>Art. 099990195.0</b> 01 <input type="text"/> <input type="text"/> <input type="text"/> <input type="text"/> <input type="text"/> <input type="text"/> <input type="text"/> <input type="text"/> <input type="text"/> <input type="text"/> <input type="text"/> <input type="text"/> <input type="text"/> <input type="text"/> <input type="text"/> <input type="text"/> <input type="text"/> <input type="text"/> <input type="text"/> <input type="text"/> <input type="text"/> 	Tappo Plug Tapón perfil pasamano	ALL.CO VZ 1255	PA	100 Pz
<b>Art. 099990678.0</b> 01 <input type="text"/> <input type="text"/> <input type="text"/> <input type="text"/> <input type="text"/> <input type="text"/> <input type="text"/> <input type="text"/> <input type="text"/> <input type="text"/> <input type="text"/> <input type="text"/> <input type="text"/> <input type="text"/> <input type="text"/> <input type="text"/> <input type="text"/> <input type="text"/> <input type="text"/> <input type="text"/> <input type="text"/> 	Copriangolo Cover angle Cubre ángulo	ALPHA 255	PA	200 Pz
<b>Art. 099992623.3</b> 01 <input type="text"/> <input type="text"/> <input type="text"/> <input type="text"/> <input type="text"/> <input type="text"/> <input type="text"/> <input type="text"/> <input type="text"/> <input type="text"/> <input type="text"/> <input type="text"/> <input type="text"/> <input type="text"/> <input type="text"/> <input type="text"/> <input type="text"/> <input type="text"/> <input type="text"/> <input type="text"/> <input type="text"/> 	Coppia tappi riporto centrale inversione battuta Pair of plugs for central rabbet rebated reverse Juego tapón inversor	R 40 REVAMPING con mezzaluna half-moon media luna	PA	25 coppie pairs parejas
<b>Art. 099992778.3</b> 01 <input type="text"/> <input type="text"/> <input type="text"/> <input type="text"/> <input type="text"/> <input type="text"/> <input type="text"/> <input type="text"/> <input type="text"/> <input type="text"/> <input type="text"/> <input type="text"/> <input type="text"/> <input type="text"/> <input type="text"/> <input type="text"/> <input type="text"/> <input type="text"/> <input type="text"/> <input type="text"/> <input type="text"/> 	Coppia tappi riporto centrale inversione battuta Pair of plugs for central rabbet rebated reverse Juego tapón inversor	R 50 TT con mezzaluna half-moon media luna	PA	50 coppie pairs parejas
<b>Art. 099992779.3</b> 01 <input type="text"/> <input type="text"/> <input type="text"/> <input type="text"/> <input type="text"/> <input type="text"/> <input type="text"/> <input type="text"/> <input type="text"/> <input type="text"/> <input type="text"/> <input type="text"/> <input type="text"/> <input type="text"/> <input type="text"/> <input type="text"/> <input type="text"/> <input type="text"/> <input type="text"/> <input type="text"/> <input type="text"/> 	Coppia tappi riporto centrale inversione battuta Pair of plugs for central rabbet rebated reverse Juego tapón inversor	R 50	PA	25 coppie pairs parejas

00  
neutro  
neutral  
neutro

01  
nero 9005  
black 9005  
negro 9005

02  
bianco  
white  
blanco

03  
bianco 1013  
white 1013  
blanco 1013

04  
bianco 9010  
white 9010  
blanco 9010

05  
verde  
green  
verde

06  
verde 6005  
green 6005  
verde 6005

07  
marrone  
brown  
marrone

08  
marrone 8017  
brown 8017  
marrone 8017

09  
giallo 1006  
yellow 1006  
amarillo 1006

10  
grigio 7001  
grey 7001  
gris 7001

13  
rosso 3003  
red 3003  
rojo 3003

14  
argento  
silver  
plateado

15  
bronzo  
bronze  
bronce

Art. 099992813.3 01



DESCRIZIONE DESCRIPTION DESCRIPCIÓN	APPLICAZIONE APPLICATION APLICACIÓN	MATERIALE MATERIAL MATERIAL	SCATOLA BOX CAJA
Coppia tappi riporto centrale inversione battuta Pair of plugs for central rabet rebated reverse Juego tapón inversor	R 40 dritto e arrotondato storico straight and storic rounded recto y redondeado histórico	PA	25 coppie pairs parejas

Art. 099992828.3 01



Coppia tappi riporto centrale inversione battuta Pair of plugs for central rabet rebated reverse Juego tapón inversor	R 40 dritto straight recto	PA	25 coppie pairs parejas
---	----------------------------------	----	----------------------------------

Art. 099992777.3 01



Coppia tappi riporto centrale inversione battuta Pair of plugs for central rabet rebated reverse Juego tapón inversor	ALL.CO EXPORT 45 / 45 TT	PA	50 coppie pairs parejas
---	--------------------------	----	----------------------------------

Art. 099992786.3 01



Coppia tappi riporto centrale inversione battuta Pair of plugs for central rabet rebated reverse Juego tapón inversor	ALL.CO 5 sormonto overlapped part solapado	PA	25 coppie pairs parejas
---	--	----	----------------------------------

Art. 099992787.3 01



Coppia tappi riporto centrale inversione battuta Pair of plugs for central rabet rebated reverse Juego tapón inversor	ALL.CO EXPORT 50	PA	25 coppie pairs parejas
---	------------------	----	----------------------------------

Art. 099992788.3 01



Coppia tappi riporto centrale inversione battuta Pair of plugs for central rabet rebated reverse Juego tapón inversor	ALL.CO EXPORT 50 TT	PA	25 coppie pairs parejas
---	---------------------	----	----------------------------------

16  
 elettro col. nero  
 electrum col. black  
 anodizado col. negro

25  
 marrone 8014  
 brown 8014  
 marrone 8014

26  
 verde 5293  
 gothic 5293  
 verde 5293

37  
 ottone  
 brass  
 ottone

39  
 nero opaco  
 opaque black  
 negro opaco

60  
 verde 5123  
 green 5123  
 verde 5123



68  
 grigio 9006  
 gothic 9006  
 gris 9006

77  
 cromo  
 chrome  
 cromo

MO  
 mogano  
 mahogany  
 caoba

NO  
 noce  
 walnut  
 nogal

RO  
 rovere  
 oak  
 roble

DESCRIZIONE DESCRIPTION DESCRIPCIÓN	APPLICAZIONE APPLICATION APLICACIÓN	MATERIALE MATERIAL MATERIAL	SCATOLA BOX CAJA
<p><b>Art. 099992793.3</b> 01</p>  <p>Coppia tappi riporto centrale inversione battuta                      Pair of plugs for central rabbet rebated reverse                      Juego tapón inversor</p>	ALL.CO WOOD	PA	25 coppie pairs parejas
<p><b>Art. 099992797.3</b> 01</p>  <p>Coppia tappi riporto centrale inversione battuta                      Pair of plugs for central rabbet rebated reverse                      Juego tapón inversor</p>	nuovo new nuovo NC 40 METRA	PA	50 coppie pairs parejas
<p><b>Art. 099992806.3</b> 01</p>  <p>Coppia tappi riporto centrale inversione battuta                      Pair of plugs for central rabbet rebated reverse                      Juego tapón inversor</p>	DOMAL 40	PA	50 coppie pairs parejas
<p><b>Art. 099992807.3</b> 01</p>  <p>Coppia tappi riporto centrale inversione battuta                      Pair of plugs for central rabbet rebated reverse                      Juego tapón inversor</p>	DOMAL STOPPER PG 19664-23251	PA	50 coppie pairs parejas
<p><b>Art. 099992848.3</b> 01</p>  <p>Coppia tappi riporto centrale inversione battuta                      Pair of plugs for central rabbet rebated reverse                      Juego tapón inversor</p>	DOMAL STOPPER PG 19663	PA	25 coppie pairs parejas
<p><b>Art. 099992850.3</b> 01</p>  <p>Coppia tappi riporto centrale inversione battuta                      Pair of plugs for central rabbet rebated reverse                      Juego tapón inversor</p>	DOMAL BREAK PA 52	PA	25 coppie pairs parejas

00 neutro neutral neutro	01 nero 9005 black 9005 negro 9005	02 bianco white blanco	03 bianco 1013 white 1013 blanco 1013	04 bianco 9010 white 9010 blanco 9010	05 verde green verde	06 verde 6005 green 6005 verde 6005	07 marrone brown marrone	08 marrone 8017 brown 8017 marrone 8017	09 giallo 1006 yellow 1006 amarillo 1006	10 grigio 7001 grey 7001 gris 7001	13 rosso 3003 red 3003 rojo 3003	14 argento silver plateado	15 bronzo bronze bronce
-----------------------------------	---	---------------------------------	--	--	-------------------------------	--	-----------------------------------	--	---	---	---	-------------------------------------	----------------------------------

Art. 099992954.3 01



DESCRIZIONE DESCRIPTION DESCRIPCIÓN	APPLICAZIONE APPLICATION APLICACIÓN	MATERIALE MATERIAL MATERIAL	SCATOLA BOX CAJA
Coppia tappi riporto centrale Pair of plugs for central rabbet Juego tapón inversor	EKU 45 17675	PA	25 coppie pairs parejas

Art. 099992916.0 01



Profilo portaspazzolino da m 3 per camera da mm 25 3 m brush holder profile for camera 25 mm Perfil porta felpa de 3 m para cámara de 25 mm		PVC	100 barre rods varillas
---	--	-----	----------------------------------

Art.

--	--	--	--

Art.

--	--	--	--

Art.

--	--	--	--

Art.

--	--	--	--

16

eletto col. nero  
electron col. black  
anodizado col. negro

25

marrone 8014  
brown 8014  
marrone 8014

26

verde 5293  
gothic 5293  
verde 5293

37

ottone  
brass  
ottone

39

nero opaco  
opaque black  
negro opaco

60

verde 5123  
green 5123  
verde 5123

68

grigio 9006  
gothic 9006  
gris 9006

77

cromo  
chrome  
cromo

MO

mogano  
mahogany  
caoba

NO

noce  
walnut  
nogal

RO

rovere  
oak  
roble

		DESCRIZIONE DESCRIPTION DESCRIPCIÓN	APPLICAZIONE APPLICATION APLICACIÓN	MATERIALE MATERIAL MATERIAL	SCATOLA BOX CAJA
<b>Art.</b>					
<b>Art.</b>					
<b>Art.</b>					
<b>Art.</b>					
<b>Art.</b>					
<b>Art.</b>					





# SISTEMI DI CHIUSURA

CLOSING  
SYSTEMS

SISTEMAS  
DE CIERRE

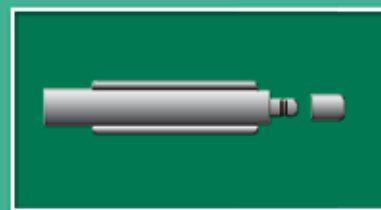

Art. 099992953.0 01

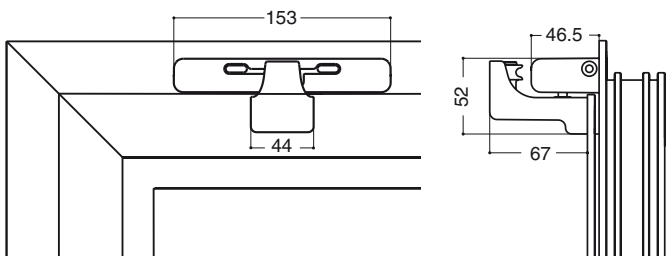

DESCRIZIONE  
DESCRIPTION  
DESCRIPCIÓN

MATERIALE  
MATERIAL  
MATERIALE

SCATOLA  
BOX  
CAJA

**SCARABEO** (Brevettato)  
chiusura per infissi a wasistas in alluminio con sormonto  
telaio - anta da mm 0 a 12 max e corda m 4

**SCARABEO** (Patented)  
lock for awning fixture in aluminium with frame  
overlapped part- door from 0 to 12 mm max and  
4 m string

**SCARABEO** (Patentado)  
cierre para puertas y ventanas abatibles en aluminio  
con superposición max bastidor- hoja de 0-12 mm  
y cuerda de 4 m

PA  
e  
VARI

25  
Pz

Art. 099992998.0 01



**SCARABEO** (Brevettato)  
chiusura per infissi a wasistas in legno e pvc con sormonto  
telaio - anta da mm 0 a 12 max e corda m 4

**SCARABEO** (Patented)  
lock for awning fixture in wood and pvc with frame  
overlapped part- door from 0 to 12 mm max and  
4 m string

**SCARABEO** (Patentado)  
cierre para puertas y ventanas abatibles en madera  
y pvc con superposicion max bastidor- hoja de 0-12 mm  
y cuerda de 4 m

PA  
e  
VARI

25  
Pz

Art. 099992984.0 01



**DIMA**  
maschera di foratura per montaggio SCARABEO

**DIMA**  
drill plate for SCARABEO assembly

**DIMA**  
plantilla para montaje SCARABEO

ABS

16  
 elettro col. nero  
 electrum col. black  
 anodizado col. negro

25  
 marrone 8014  
 brown 8014  
 marrone 8014

26  
 verde 5293  
 gothic 5293  
 verde 5293

37  
 ottone  
 brass  
 ottone

39  
 nero opaco  
 opaque black  
 negro opaco

60  
 verde 5123  
 green 5123  
 verde 5123

68  
 grigio 9006  
 gothic 9006  
 gris 9006

77  
 cromo  
 chrome  
 cromo

MO  
 mogano  
 mahogany  
 caoba

NO  
 noce  
 walnut  
 nogal

RO  
 rovere  
 oak  
 roble

Art. 099992966.0 01	DESCRIZIONE DESCRIPTION DESCRIPCIÓN	MATERIALE MATERIAL MATERIALE	SCATOLA BOX CAJA
	<p>Kit spessori per SCARABEO stampato in nero                      Thickness kit for SCARABEO black colour printed                      Kit espesores para SCARABEO estampado en color negro</p>	<p>ABS</p>	<p>50 Pz</p>
<p>Art. 099992968.0 03 04 06 08 10 14 25 37 68 77 MO NO RO</p> 	<p>Kit spessori per SCARABEO verniciati                      Painted thickness kit for SCARABEO                      Kit espesores barnizados para SCARABEO</p>	<p>ABS</p>	<p>50 Pz</p>
<p>Art. 099993028.0 01</p> 	<p>Kit copertura per SCARABEO stampato in nero                      Covering kit for SCARABEO black colour printed                      Kit cubiertas para SCARABEO estampado en color negro</p>	<p>ABS</p>	<p>10 Pz</p>
<p>Art. 099992965.0 03 04 06 08 10 14 25 37 68 77 MO NO RO</p> 	<p>Kit copertura per SCARABEO verniciata                      Painted covering kit for SCARABEO                      Kit cubiertas barnizados para SCARABEO</p>	<p>ABS</p>	<p>10 Pz</p>

00	01	02	03	04	05	06	07	08	09	10	13	14	15
neutro neutral neutro	nero 9005 black 9005 negro 9005	bianco white blanco	bianco 1013 white 1013 blanco 1013	bianco 9010 white 9010 blanco 9010	verde green verde	verde 6005 green 6005 verde 6005	marone brown marone	marone 8017 brown 8017 marone 8017	giallo 1006 yellow 1006 amarillo 1006	grigio 7001 grey 7001 gris 7001	rosso 3003 red 3003 rojo 3003	argento silver plateado	bronzo bronze bronce

Art. 099992989.0 01



DESCRIZIONE DESCRIPTION DESCRIPCIÓN	APPLICAZIONE APPLICATION APLICACIÓN	MATERIALE MATERIAL	SCATOLA BOX CAJA
Corda per SCARABEO da m 6 6 m string for SCARABEO Cuerda de 6 m para SCARABEO			

Art. 099992952.1 00

Art. 099992952.2 00

Art. 099992952.3 00

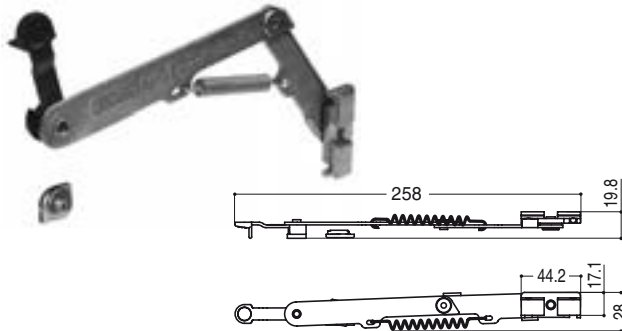

<b>RENATO</b> (Brevettato) braccio dx - sx per wasistas in alluminio <b>RENATO</b> (Patented) Right - left arm for awning in aluminium <b>RENATO</b> (Patentado) brazo dch-izd para abatibles en aluminio	DOMAL BREAK - GELOSIA/ STOPPER PG - GOLD EXPORT - EKIP 40 ALL.CO K40 / 5TT / P4 nuovo new nuovo NC40 - R40 / R 50TT / R 62 / R 72 NEW TEC 50 / 52 / 60 / 68ST ESEDRA GA 53 ESEDRA LIGHT 42/50 ESEDRA TT 63 / TT 75	ACC	25 coppie pairs parejas
---	---	-----	----------------------------------

Art. 099992999.1 00

Art. 099992999.2 00

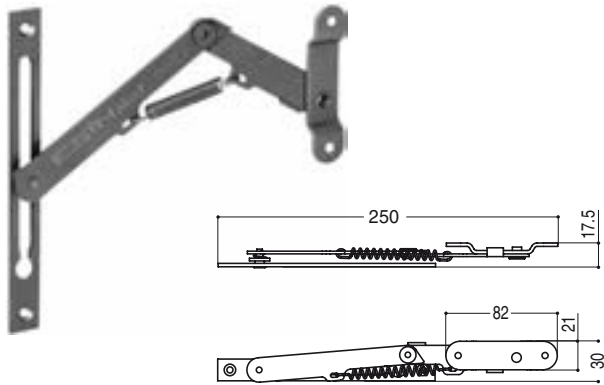

<b>RENATO</b> (Brevettato) braccio dx - sx per wasistas in legno o pvc <b>RENATO</b> (Patented) Right - left arm for awning in wood and pvc <b>RENATO</b> (Patentado) brazo dch-izd para abatibles en madera y pvc		ACC	50 Pz
--	--	-----	----------

Art. 099990295.0 01 03 04

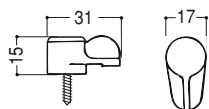

<b>COCCINELLA</b> chiusura per scuretti, cas- sonetti, bacheche, etc con spessori da mm 1 - 1,2 - 2 - 3 <b>COCCINELLA</b> lock for shutters, boxes, notice boards etc., with 1 - 1.2 - 2 - 3 mm thicknesses <b>COCCINELLA</b> cierre para postigos, cajo- nes, tablonas, etc. con espesores de 1 - 1,2 - 2 - 3 mm		PA	10 Pz
---	--	----	----------

16  
 eletto col. nero  
 electrum col. black  
 anodizado col. negro

25  
 marrone 8014  
 brown 8014  
 marrone 8014

26  
 verde 5293  
 gothic 5293  
 verde 5293

37  
 ottone  
 brass  
 ottone

39  
 nero opaco  
 opaque black  
 negro opaco

60  
 verde 5123  
 green 5123  
 verde 5123

68  
 grigio 9006  
 gothic 9006  
 gris 9006

77  
 cromo  
 chrome  
 cromo

MO  
 mogano  
 mahogany  
 caoba

NO  
 noce  
 walnut  
 nogal

RO  
 rovere  
 oak  
 roble

Art. 099992174.0 01

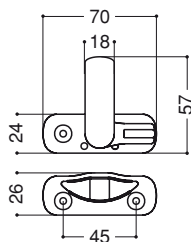

**CHIOCCIOLA**  
 chiudi anta a tirare con spessore da mm 2,5 viti inox e tappi copriforo

**CHIOCCIOLA**  
 2,5 mm thick, stainless steel screws and hole plugs closure

**CHIOCCIOLA**  
 cierre de presión con espesor de 2,5 mm tornillos acero inoxidable y tapones

DESCRIZIONE DESCRIPTION DESCRIPCIÓN	MATERIALE MATERIAL MATERIALE	SCATOLA BOX CAJA
	PA	100 Pz

Art. 099992183.0 01

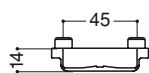

Vaschetta di riscontro per chiudi anta a spingere  
 Checking cup for pushing door closure  
 Cerradero para cierres de presión

	PA	100 Pz
--	----	-----------

Art. 099992189.0 01

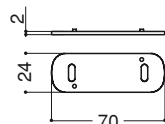

Spessore per **CHIOCCIOLA** da mm 2  
 2 mm thickness for **CHIOCCIOLA**  
 Espesor de 2 mm para **CHIOCCIOLA**

	PA	100 Pz
--	----	-----------

Art. 099992190.0 01

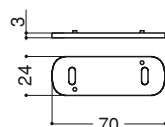

Spessore per **CHIOCCIOLA** da mm 3  
 3 mm thickness for **CHIOCCIOLA**  
 Espesor de 3 mm para **CHIOCCIOLA**

	PA	100 Pz
--	----	-----------

00	01	02	03	04	05	06	07	08	09	10	13	14	15
neutro neutral neutro	nero 9005 black 9005 negro 9005	bianco white blanco	bianco 1013 white 1013 blanco 1013	bianco 9010 white 9010 blanco 9010	verde green verde	verde 6005 green 6005 verde 6005	marone brown marone	marone 8017 brown 8017 marone 8017	giallo 1006 yellow 1006 amarillo 1006	grigio 7001 grey 7001 gris 7001	rosso 3003 red 3003 rojo 3003	argento silver plateado	bronz bronze bronce

Art. 09992182.0 01

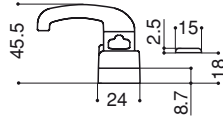

DESCRIZIONE DESCRIPTION DESCRIPCIÓN	MATERIALE MATERIAL MATERIALE	SCATOLA BOX CAJA
<p><b>CHIOCCIOLA</b> chiudi anta a tirare per infissi con spessore battuta minimo mm 18 con tappi copriforo</p> <p><b>CHIOCCIOLA</b> for closure of pulling door for fixture, with minimum ledge thickness of 18 mm with hole plugs</p> <p><b>CHIOCCIOLA</b> cierre de presión para cerramientos con espesor tope mínimo de 18 mm y tapones</p>	PA	100 Pz

Art. 09992799.1 01 Dx  
09992799.2 01 Sx

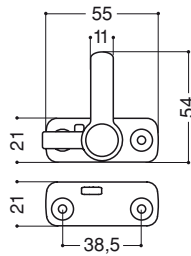

<p><b>CHIOCCIOLA</b> chiudi anta a tirare con spessore da mm 2,5 viti inox e tappi copriforo</p> <p><b>CHIOCCIOLA</b> 2,5 mm thick, stainless steel screws and hole plugs for closure of pulling door</p> <p><b>CHIOCCIOLA</b> cierre de presión con espesor de 2,5 mm tornillos acero inoxidable y tapones</p>	PA	100 Pz
---	----	-----------

Art. 09992800.1 01 Dx  
09992800.2 01 Sx  
09992800.3 01 Dx - Sx

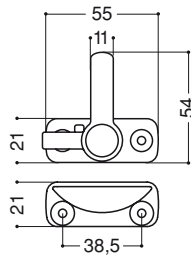

<p><b>CHIOCCIOLA</b> chiudi anta a spingere dx - sx con spessore da mm 2,5 viti inox e tappi copriforo</p> <p><b>CHIOCCIOLA</b> Right - left 2,5 mm thick, stainless steel screws and hole plugs for closure of pushing door</p> <p><b>CHIOCCIOLA</b> cierre de presión dch-izd con espesor de 2,5 mm tornillos acero inoxidable y tapones</p>	PA	100 Pz
--	----	-----------

Art. 09992709.0 01 03 04

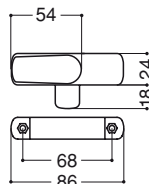

<p>Tavellino universale maniglia piccola con spessori di compensazione da mm 3 - 4 - 5</p> <p>Universal flat catch small handle with 3 - 4 - 5 mm compensation thicknesses</p> <p>Cierre de presión universal maneta pequeña con espesores de compensación de 3 - 4 - 5 mm</p>	PA	20 Pz
--	----	----------

16  
 eletto col. nero  
 electrum col. black  
 anodizado col. negro

25  
 marrone 8014  
 brown 8014  
 marrone 8014

26  
 verde 5293  
 gothic 5293  
 verde 5293

37  
 ottone  
 brass  
 ottone

39  
 nero opaco  
 opaque black  
 negro opaco

60  
 verde 5123  
 green 5123  
 verde 5123

68  
 grigio 9006  
 gothic 9006  
 gris 9006

77  
 cromo  
 chrome  
 cromo

MO  
 mogano  
 mahogany  
 caoba

NO  
 noce  
 walnut  
 nogal

RO  
 rovere  
 oak  
 roble

Art. 099992710.0 01 03 04

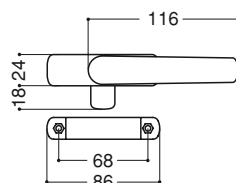

DESCRIZIONE DESCRIPTION DESCRIPCIÓN	MATERIALE MATERIAL MATERIALE	SCATOLA BOX CAJA
<p>Tavellino universale maniglia grande con spessori di compensazione da mm 3 - 4 - 5</p> <p>Universal flat catch, large handle with 3 - 4 - 5 mm compensation thicknesses</p> <p>Cierre de presión universal maneta grande con espesores de compensación de 3 - 4 - 5 mm</p>	PA	20 Pz

Art. 099992893.0 01

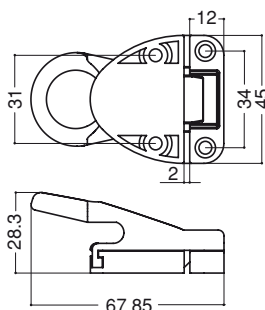

<p><b>CLAC</b>                      Cricchetto con viti a vista e spessori di compensazione da mm 1 - 2 - 3 - 7</p> <p><b>CLAC</b>                      Finger catch with in full view screws and 1 - 2 - 3 - 7 mm compensation thickness</p> <p><b>CLAC</b>                      Cierre golpete con tornillo visto y espesores de compensación de 1 - 2 - 3 - 7 mm</p>	PA	100 Pz
---	----	-----------

Art. 099992894.0 01

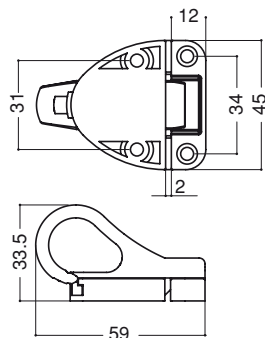

<p><b>CLIC</b>                      Cricchetto con viti a scomparsa e spessori di compensazione da mm 1 - 2 - 3 - 7</p> <p><b>CLIC</b>                      Finger catch with hidden screws and 1 - 2 - 3 - 7 mm compensation thickness</p> <p><b>CLIC</b>                      Cierre golpete con tornillo oculto y espesores de compensación de 1 - 2 - 3 - 7 mm</p>	PA	100 Pz
--	----	-----------

Art. 099992128.0 01 03 04

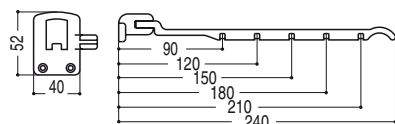

<p><b>BREZZA</b>                      chiusura manuale per serramenti con anta a sporgere (dima di foratura cod. 2143)</p> <p><b>BREZZA</b>                      manual lock for window and door frames with protruding door (panel cutout code 2143)</p> <p><b>BREZZA</b>                      Cierre manual para ventanas abatibles con hoja sobresaliente (plantilla de perforación cód. 2143)</p>		20 Pz
---	--	----------



00	01	02	03	04	05	06	07	08	09	10	13	14	15
neutro neutral neutro	nero 9005 black 9005 negro 9005	bianco white blanco	bianco 1013 white 1013 blanco 1013	bianco 9010 white 9010 blanco 9010	verde green verde	verde 6005 green 6005 verde 6005	marone brown marone	marone 8017 brown 8017 marone 8017	giallo 1006 yellow 1006 amarillo 1006	grigio 7001 grey 7001 gris 7001	rosso 3003 red 3003 rojo 3003	argento silver plateado	bronz bronze bronce

Art. 099992781.0 01 03 04

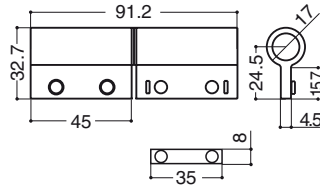

DESCRIZIONE DESCRIPTION DESCRIPCIÓN	MATERIALE MATERIAL MATERIAL	SCATOLA BOX CAJA
<p>Cerniera per zanzariera a battente senza molla con piastrino per profilo R40</p> <p>Hinge for hinged mosquito net framework without spring with plate for profile R40</p> <p>Bisagra para mosquitera practicable sin muelle con placa para perfile R40</p>	PA	100 Pz

Art. 099992782.0 01 03 04

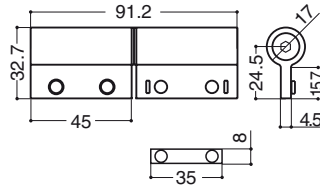

<p>Cerniera per zanzariera a battente con molla e piastrino con perno di regolazione in zama per profilo R40</p> <p>Hinge for hinged mosquito net framework with spring and plate, with rigging pin made of zama for profile R40</p> <p>Bisagra para mosquitera practicable con muelle y placa, eje regulable en zamak para perfile R40</p>	PA	50 Pz
---	----	----------

Art. 099992617.0 01 03 04

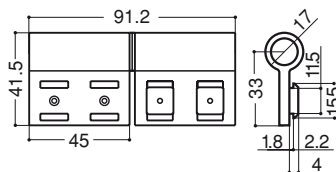

<p>Cerniera per zanzariera a battente senza molla</p> <p>Hinge for hinged mosquito net framework without spring</p> <p>Bisagra para mosquitera practicable sin muelle</p>	PA	50 Pz
---	----	----------

Art. 099992618.0 01 03 04

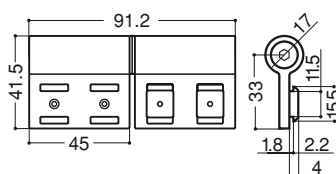

<p>Cerniera per zanzariera a battente con molla e perno di regolazione in zama</p> <p>Hinge for hinged mosquito net framework with spring and rigging pin made of zama</p> <p>Bisagra para mosquitera practicable con muelle y eje regulable en zamak</p>	PA	50 Pz
---	----	----------

16  
 eletto col. nero  
 electrum col. black  
 anodizado col. negro

25  
 marrone 8014  
 brown 8014  
 marrone 8014

26  
 verde 5293  
 gothic 5293  
 verde 5293

37  
 ottone  
 brass  
 ottone

39  
 nero opaco  
 opaque black  
 negro opaco

60  
 verde 5123  
 green 5123  
 verde 5123

68  
 grigio 9006  
 gothic 9006  
 gris 9006

77  
 cromo  
 chrome  
 cromo

MO  
 mogano  
 mahogany  
 caoba

NO  
 noce  
 walnut  
 nogal

RO  
 rovere  
 oak  
 roble

Art. 099992711.0 01 03 04

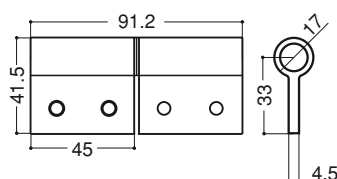

DESCRIZIONE  
 DESCRIPTION  
 DESCRIPCIÓN

Cerniera per zanzariera a battente piana senza molla  
 Hinge for hinged mosquito net framework  
 flat without spring  
 Bisagra para mosquitera practicable plana sin muelle

MATERIALE  
 MATERIAL  
 MATERIALE

SCATOLA  
 BOX  
 CAJA

PA

50  
 Pz

Art. 099992712.0 01 03 04

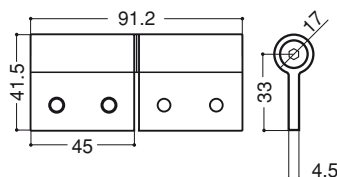

Cerniera per zanzariera a battente piana con molla e perno di regolazione in zama  
 Hinge for hinged mosquito net framework  
 flat with spring and rigging pin made of zama  
 Bisagra para mosquitera practicable plana con muelle y eje regulable en zamak

PA

50  
 Pz

Art. 099992713.0 01 03 04

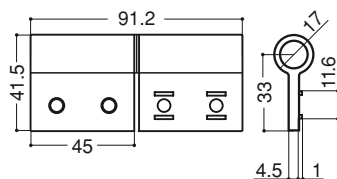

Cerniera per zanzariera a battente senza molla e guida da mm 11,6  
 Hinge for hinged mosquito net framework without  
 spring and 11.6 mm rail  
 Bisagra para mosquitera practicable sin muelle con guia de 11,6 mm

PA

50  
 Pz

Art. 099992714.0 01 03 04

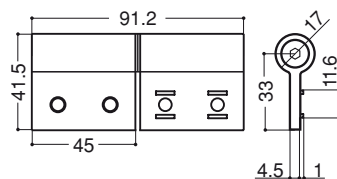

Cerniera per zanzariera a battente con molla, perno di regolazione in zama e guida da mm 11,6  
 Hinge for hinged mosquito net framework with spring,  
 rigging pin made of zama and 11,6 mm rail  
 Bisagra para mosquitera practicable con muelle, eje regulable en zamak y guia de 11,6 mm

PA

50  
 Pz

00  
neutro  
neutral  
neutro

01  
nero 9005  
black 9005  
negro 9005

02  
bianco  
white  
blanco

03  
bianco 1013  
white 1013  
blanco 1013

04  
bianco 9010  
white 9010  
blanco 9010

05  
verde  
green  
verde

06  
verde 6005  
green 6005  
verde 6005

07  
marrone  
brown  
marrone

08  
marrone 8017  
brown 8017  
marrone 8017

09  
giallo 1006  
yellow 1006  
amarillo 1006

10  
grigio 7001  
grey 7001  
gris 7001

13  
rosso 3003  
red 3003  
rojo 3003

14  
argento  
silver  
plateado

15  
bronzo  
bronze  
bronce

Art. 09992715.0 01 03 04

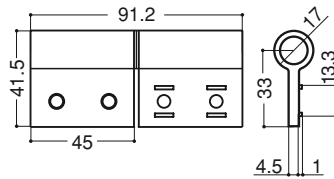

Cerniera per zanzariera a battente senza molla e guida da mm 13,3  
Hinge for hinged mosquito net framework without spring and 13,3 mm rail  
Bisagra para mosquitera practicable sin muelle con guía de 13,3 mm

DESCRIZIONE  
DESCRIPTION  
DESCRIPCIÓN

MATERIALE  
MATERIAL  
MATERIAL

PA

SCATOLA  
BOX  
CAJA

50  
Pz

Art. 09992716.0 01 03 04

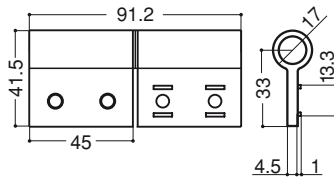

Cerniera per zanzariera a battente con molla, guida da mm 13,3 e perno di regolazione in zama  
Hinge for hinged mosquito net framework with spring, 13,3 mm rail and rigging pin made of zama  
Bisagra para mosquitera practicable con muelle, guía de 13,3 mm y eje regulable en zamak

MATERIALE  
MATERIAL  
MATERIAL

PA

SCATOLA  
BOX  
CAJA

50  
Pz

Art. 09992961.0 01 03 04

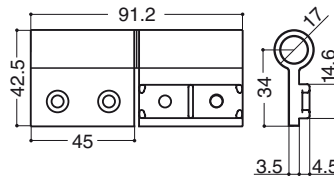

Cerniera per zanzariera a battente senza molla con denti da mm 14,6  
Hinge for hinged mosquito net framework without spring with 14,6 mm teeth  
Bisagra para mosquitera practicable sin muelle con dientes de 14,6 mm

MATERIALE  
MATERIAL  
MATERIAL

PA

SCATOLA  
BOX  
CAJA

50  
Pz

Art. 09992962.0 01 03 04

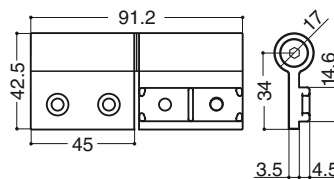

Cerniera per zanzariera a battente con molla, denti da mm 14,6 e perno di regolazione in zama  
Hinge for hinged mosquito net framework with spring, 14,6 mm teeth and rigging pin made of zama  
Bisagra para mosquitera practicable con muelle, dientes de 14,6 mm y eje regulable en zamak

MATERIALE  
MATERIAL  
MATERIAL

PA

SCATOLA  
BOX  
CAJA

50  
Pz

16  
 elettro col. nero  
 electrum col. black  
 anodizado col. negro

25  
 marrone 8014  
 brown 8014  
 marrone 8014

26  
 verde 5293  
 gothic 5293  
 verde 5293

37  
 ottone  
 brass  
 ottone

39  
 nero opaco  
 opaque black  
 negro opaco

60  
 verde 5123  
 green 5123  
 verde 5123



68  
 grigio 9006  
 gothic 9006  
 gris 9006

77  
 cromo  
 chrome  
 cromo

MO  
 mogano  
 mahogany  
 caoba

NO  
 noce  
 walnut  
 nogal

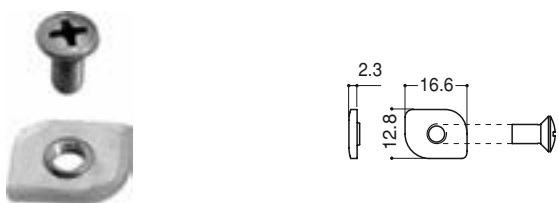
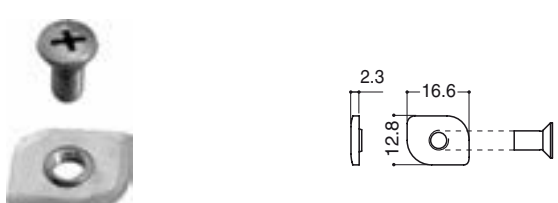
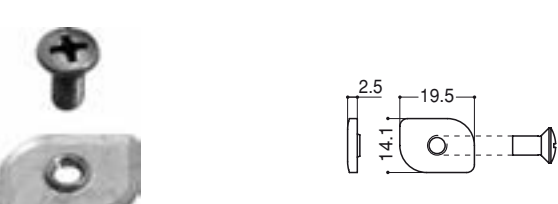
RO  
 rovere  
 oak  
 roble

Art. 09992717.0 00	DESCRIZIONE DESCRIPTION DESCRIPCIÓN	MATERIALE MATERIAL MATERIALE	SCATOLA BOX CAJA
	<p>Kit con dado farfalla zincato da mm 16,6 e vite inox M5 x 10</p> <p>Kit with 16,6 mm galvanized butterfly nut and M5 x 10 stainless steel screw</p> <p>Kit excéntrica cincada de 16,6 mm y tornillo inox M5 x 10</p>		200 Pz
	<p>Kit con dado farfalla zincato da mm 16,6 e vite inox TSP M5 x 8</p> <p>Kit with 16,6 mm galvanized butterfly nut and TSP M5 x 8 stainless steel screw</p> <p>Kit excéntrica cincada de 16,6 mm y tornillo inox cabeza avellanada TSP M5 x 8</p>		50 Pz
	<p>Kit con dado farfalla zincato da mm 19,5 e vite inox M5 x 10</p> <p>Kit with 19,5 mm galvanized butterfly nut and M5 x 10 stainless steel screw</p> <p>Kit excéntrica cincada de 19,5 mm y tornillo inox M5 x 10</p>		200 Pz
	<p>Rondella per cardine diametro interno mm 12</p> <p>Washer for 12 mm internal diameter pintle</p> <p>Arandela diámetro interno 12 mm</p>	PA	500 Pz
	<p>Cerniera MAXI mm 48 complanare</p> <p>48 mm coplanar MAXI hinge</p> <p>Bisagra MAXI 48 mm coplanar</p>	PA	50 Pz

00	01	02	03	04	05	06	07	08	09	10	13	14	15
neutro neutral neutro	nero 9005 black 9005 negro 9005	bianco white blanco	bianco 1013 white 1013 blanco 1013	bianco 9010 white 9010 blanco 9010	verde green verde	verde 6005 green 6005 verde 6005	marone brown marone	marone 8017 brown 8017 marone 8017	giallo 1006 yellow 1006 amarillo 1006	grigio 7001 grey 7001 gris 7001	rosso 3003 red 3003 rojo 3003	argento silver plateado	bronzo bronze bronce

Art. 099992147.0 01 03 04

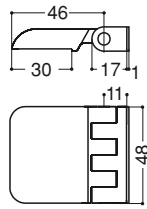

DESCRIZIONE DESCRIPTION DESCRIPCIÓN	MATERIALE MATERIAL MATERIAL	SCATOLA BOX CAJA
<p>Cerniera MEDIA mm 48 con spessore coplanare da mm 1</p> <p>48 mm MEDIA hinge with 1 mm coplanar thickness</p> <p>Bisagra MEDIA 48 mm con espesor coplanar de 1 mm</p>	PA	50 Pz

Art. 099992146.0 01 03 04

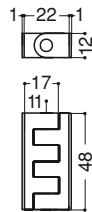

<p>Cerniera MINI mm 48 con spessore coplanare da mm 1</p> <p>48 mm MINI hinge with 1 mm coplanar thickness</p> <p>Bisagra MINI 48 mm con espesor coplanar de 1 mm</p>	PA	50 Pz
---	----	----------

Art. 099992173.0 01 03 04

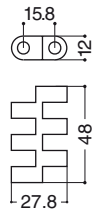

<p>Snodo per cerniera MAXI, MEDIA, MINI da mm 48 per rotazione a 360° completo di perno</p> <p>48 mm MAXI, MEDIA, MINI hinged joint for 360° rotation provided with pin</p> <p>Articulación con pernio para bisagra MAXI, MEDIA, MINI de 48 mm para rotación a 360°</p>	PA	50 Pz
---	----	----------

Art. 099992149.0 01 03 04

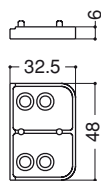

<p>Spessore coplanare da mm 6 per cerniere MEDIA - MAXI</p> <p>6 mm coplanar thickness for MEDIA - MAXI hinges</p> <p>Espesor coplanar de 6 mm para bisagras MEDIA y MAXI</p>	PA	50 Pz
---	----	----------

16  
 eletto col. nero  
 electrum col. black  
 anodizado col. negro

25  
 marrone 8014  
 brown 8014  
 marrone 8014

26  
 verde 5293  
 gothic 5293  
 verde 5293

37  
 ottone  
 brass  
 ottone

39  
 nero opaco  
 opaque black  
 negro opaco

60  
 verde 5123  
 green 5123  
 verde 5123

68  
 grigio 9006  
 gothic 9006  
 gris 9006

77  
 cromo  
 chrome  
 cromo

MO  
 mogano  
 mahogany  
 caoba

NO  
 noce  
 walnut  
 nogal

RO  
 rovere  
 oak  
 roble

Art. 099992150.0 01 03 04

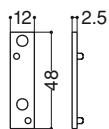

DESCRIZIONE DESCRIPTION DESCRIPCIÓN	MATERIALE MATERIAL MATERIALE	SCATOLA BOX CAJA
<p>Spessore complanare da mm 2,5 per cerniere MEDIA e MINI</p> <p>2,5 mm coplanar thickness for MEDIA and MINI hinges</p> <p>Espesor coplanar de 2,5 mm para bisagras MEDIA y MINI</p>	PA	50 Pz

Art. 099992171.0 01 03 04

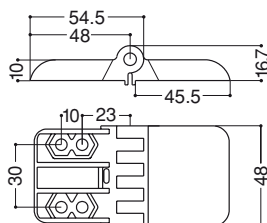

<p>Cerniera MAXI rotazione 180°</p> <p>MAXI hinge, 180° rotation</p> <p>Bisagra MAXI rotación 180°</p>	PA	50 Pz
--	----	----------

Art. 099992170.0 01 03 04

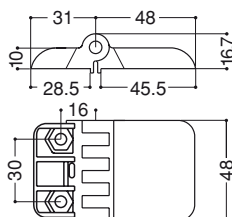

<p>Cerniera MEDIA rotazione 180°</p> <p>MEDIA hinge, 180° rotation</p> <p>Bisagra MEDIA rotación 180°</p>	PA	50 Pz
---	----	----------

Art. 099992169.0 01 03 04

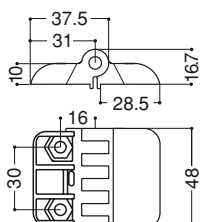

<p>Cerniera MINI rotazione 180°</p> <p>MINI hinge, 180° rotation</p> <p>Bisagra MINI rotación 180°</p>	PA	50 Pz
--	----	----------

00  
neutro  
neutral  
neutro

01  
nero 9005  
black 9005  
negro 9005

02  
bianco  
white  
blanco

03  
bianco 1013  
white 1013  
blanco 1013

04  
bianco 9010  
white 9010  
blanco 9010

05  
verde  
green  
verde

06  
verde 6005  
green 6005  
verde 6005

07  
marone  
brown  
marone

08  
marone 8017  
brown 8017  
marone 8017

09  
giallo 1006  
yellow 1006  
amarillo 1006

10  
grigio 7001  
grey 7001  
gris 7001

13  
rosso 3003  
red 3003  
rojo 3003

14  
argento  
silver  
plateado

15  
bronzo  
bronze  
bronce

Art. 099992735.0 01

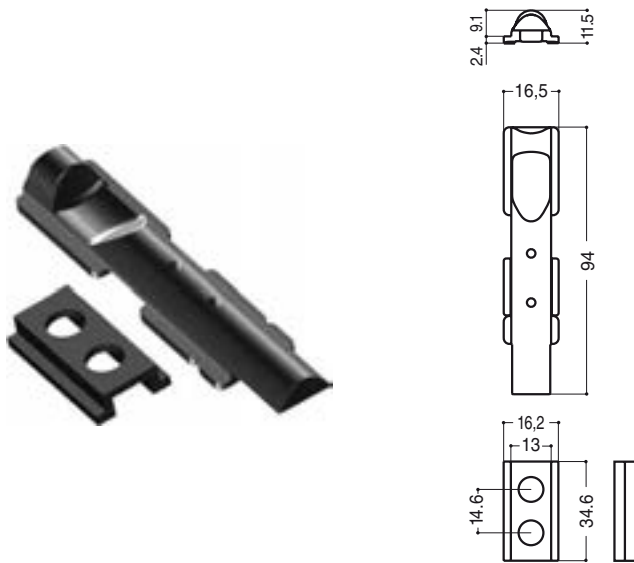

DESCRIZIONE  
DESCRIPTION  
DESCRIPCIÓN

Asta di comando da  
mm 16,5 con ponte di  
collegamento  
16,5 mm control rod with  
connection bridge  
Tirador de pasador de  
16,5 con unión para  
terminal

APPLICAZIONE  
APPLICATION  
APLICACIÓN

NC 45 INTERNATIONAL /  
SUPER THERMIC  
NC 55 INTERNATIONAL  
NC 65 / 68 / 72 SUPER  
THERMIC

MATERIALE  
MATERIAL  
MATERIALE

PA

SCATOLA  
BOX  
CAJA

100  
Pz

Art. 099992736.0 01

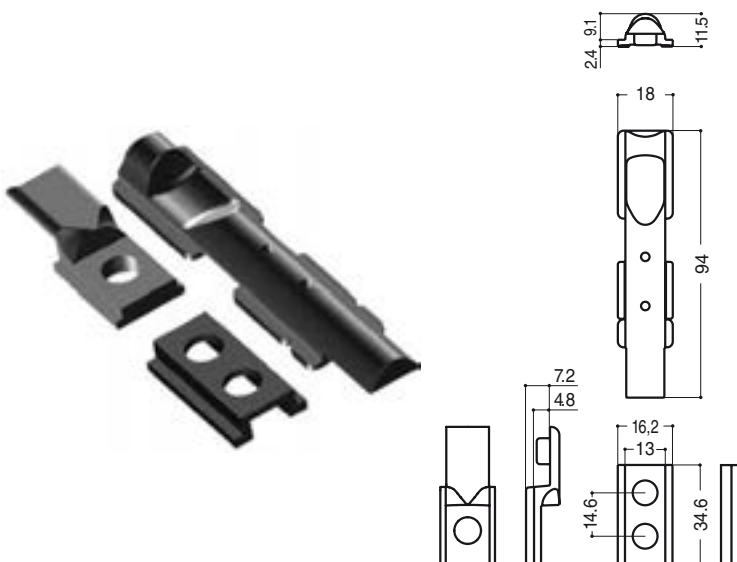

Asta di comando da  
mm 18 con ponte di  
collegamento  
18 mm control rod with  
connection bridge  
Tirador de pasador de  
18 mm con unión para  
terminal

R 40 / R 50 TT / R 62 / R 72  
NEW TEC 50 / 52 / 60 / 68 ST  
ESEDRA GA 53  
ESEDRA LIGHT 42 / 50  
ESEDRA TT 63 / TT 75

PA

100  
Pz

Art. 099992737.0 01

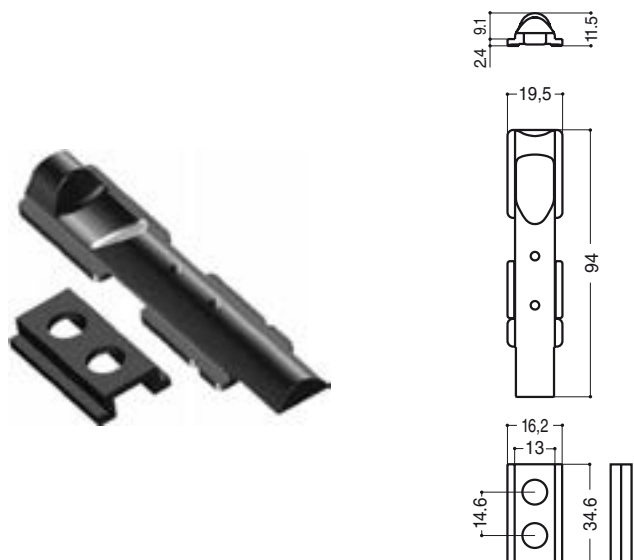

Asta di comando da  
mm 19,5 con ponte di  
collegamento  
19,5 mm control rod with  
connection bridge  
Tirador de pasador de  
19,5 mm con unión para  
terminal

DOMAL BREAK / GELOSIA /  
STOPPER PG - GOLD -  
ALL.CO K40 / STT / P4 /  
EXPORT - EKIP 40 -  
nuovo new nuovo NC 40

PA

100  
Pz

DESCRIZIONE DESCRIPTION DESCRIPCIÓN	APPLICAZIONE APPLICATION APLICACIÓN	MATERIALE MATERIAL MATERIALE	QUANTITÀ QUANTITY QUANTIA
<p><b>Art. 099992851.0</b> 01</p> <p>Asta di comando piatta da mm 18                      Flat 18 mm control rod                      Tirador plano de pasador de 18 mm</p>	<p>R 40 / R 50 TT / R 62 / R 72                      NEW TEC 50 / 52 / 60 / 68 ST                      ESEDRA GA 53                      ESEDRA LIGHT 42 / 50                      ESEDRA TT 63 / TT 75</p>	<p>PA</p>	<p>100 Pz</p>

DESCRIZIONE DESCRIPTION DESCRIPCIÓN	APPLICAZIONE APPLICATION APLICACIÓN	MATERIALE MATERIAL MATERIALE	QUANTITÀ QUANTITY QUANTIA
<p><b>Art. 099992727.0</b> 01 <b>Inox</b>  <b>099992728.0</b> 01 <b>Zincato</b></p> <p>Terminale per asta da mm 16,5 con perno inox / zincato                      16,5 mm rod terminal with stainless steel / galvanized pin                      Terminal de 16,5 mm con puntal inox / cincado</p>	<p>NC 45 INTERNATIONAL / SUPER THERMIC                      NC 55 INTERNATIONAL                      NC 65 / 68 / 72 SUPER THERMIC</p>	<p>PA</p>	<p>200 Pz</p>

DESCRIZIONE DESCRIPTION DESCRIPCIÓN	APPLICAZIONE APPLICATION APLICACIÓN	MATERIALE MATERIAL MATERIALE	QUANTITÀ QUANTITY QUANTIA
<p><b>Art. 099992730.0</b> 01</p> <p>Terminale per asta da mm 18 con ponte di collegamento per asta cremonese e perno zincato                      18 mm rod terminal with connection bridge for cremone bolt rod and stainless galvanized pin                      Terminal de 18 mm con puente de unión para varilla cremona y puntal cincado</p>		<p>PA</p>	<p>200 Pz</p>



00	01	02	03	04	05	06	07	08	09	10	13	14	15
neutro neutral neutro	nero 9005 black 9005 negro 9005	bianco white blanco	bianco 1013 white 1013 blanco 1013	bianco 9010 white 9010 blanco 9010	verde green verde	verde 6005 green 6005 verde 6005	marone brown marone	marone 8017 brown 8017 marone 8017	giallo 1006 yellow 1006 amarillo 1006	grigio 7001 grey 7001 gris 7001	rosso 3003 red 3003 rojo 3003	argento silver plateado	bronzo bronze bronce

Art. 099992733.3 01  
099992734.3 01

Inox  
Zincato

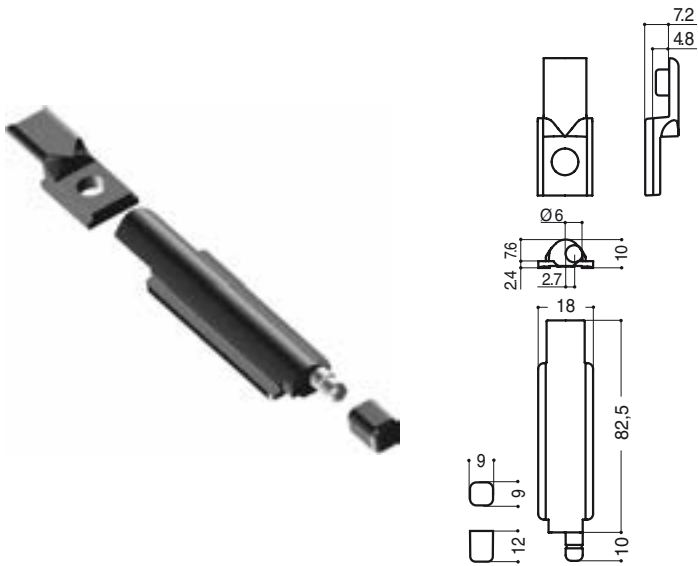

DESCRIZIONE DESCRIPTION DESCRIPCIÓN	APPLICAZIONE APPLICATION APLICACIÓN	MATERIALE MATERIAL MATERIALE	SCATOLA BOX CAJA
<p>Terminale per asta da mm 18 con ponte di collegamento per asta cremonese e perno inox / zincato decentrato</p> <p>18 mm rod terminal with connection bridge for cremonese bolt rod and decentered stainless steel / galvanized pin</p> <p>Terminal de 18 mm con puente de unión para varilla cremona y puntal descentrado inox / cincado</p>	<p>R 40 / R 50 TT / R 62 / R 72 NEW TEC 50 / 52 / 60 / 68 ST ESEDRA GA 53 ESEDRA LIGHT 42 / 50 ESEDRA TT 63 / TT 75</p>	PA	100 coppie pairs parejas

Art. 099992803.3 01

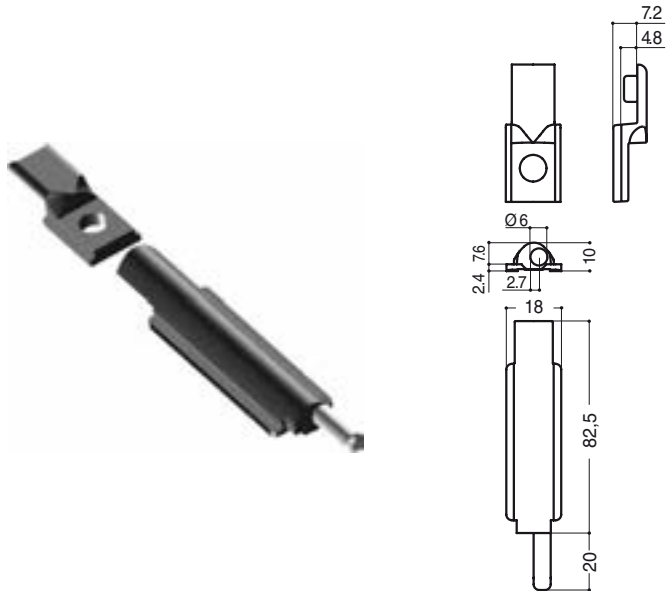

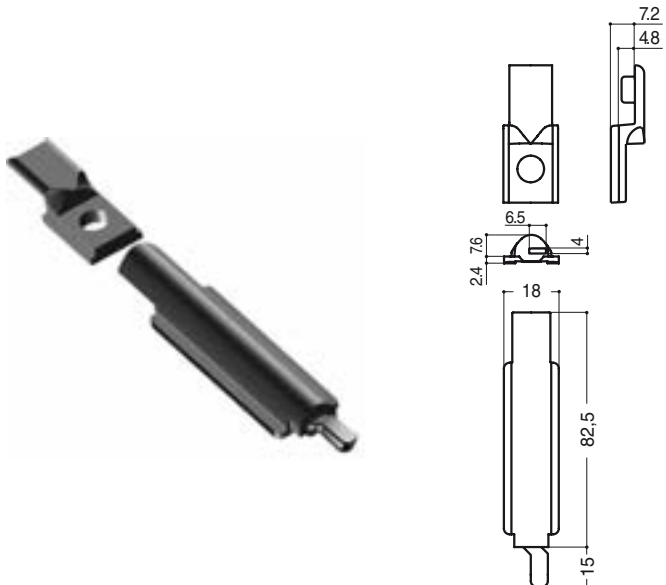

<p>Terminale dx-sx per asta da mm 18 con ponte di collegamento per asta cremonese e perno inox da mm 20</p> <p>Right - left terminal for 18 mm rod with connection bridge for cremonese bolt rod and 20 mm stainless steel pin</p> <p>Terminal dch-izd de 18 mm con puente de unión para varilla cremona y puntal inox de 20 mm</p>	<p>R 40 / R 50 TT / R 62 / R 72 NEW TEC 50 / 52 / 60 / 68 ST ESEDRA GA 53 ESEDRA LIGHT 42 / 50 ESEDRA TT 63 / TT 75</p>	PA	100 coppie pairs parejas
---	---	----	-----------------------------------

Art. 099992794.3 01

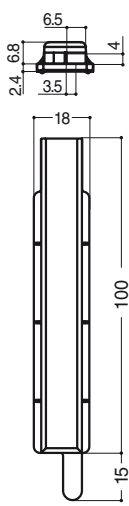

<p>Terminale dx-sx per asta da mm 18 con ponte di collegamento per asta cremonese e perno piatto zincato</p> <p>18 mm rod terminal with connection bridge for cremonese bolt rod and flat galvanized pin</p> <p>Terminal dch-izd de 18 mm con puente de unión para varilla cremona y puntal plano cincado</p>	<p>R 40 / R 50 TT / R 62 / R 72 NEW TEC 50 / 52 / 60 / 68 ST ESEDRA GA 53 ESEDRA LIGHT 42 / 50 ESEDRA TT 63 / TT 75</p>	PA	100 coppie pairs parejas
---	---	----	-----------------------------------

Art. 099992852.3	01												DESCRIZIONE DESCRIPTION DESCRIPCIÓN	APPLICAZIONE APPLICATION APLICACIÓN	MATERIALE MATERIAL MATERIALE	QUANTITÀ QUANTITY QUANTIA
													<p>Terminale dx-sx per asta da mm 18 con perno piatto zincato</p> <p>Right - left terminal for 18 mm rod with flat galvanized pin</p> <p>Terminal dch-izd de 18 mm con puntal plano cincado</p>	R 40 / R 50 TT / R 62 / R 72 NEW TEC 50 / 52 / 60 / 68 ST ESEDRA GA 53 ESEDRA LIGHT 42 / 50 ESEDRA TT 63 / TT 75	PA	100 coppie pairs parejas

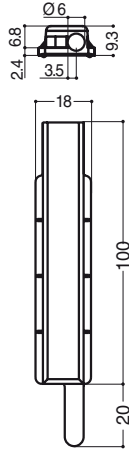
													<p>Terminale dx-sx per asta da mm 18 con perno inox da mm 20</p> <p>Right - left terminal for 18 mm rod with 20 mm stainless steel pin</p> <p>Terminal dch-izd de 18 mm con puntal inox de 20 mm</p>	R 40 / R 50 TT / R 62 / R 72 NEW TEC 50 / 52 / 60 / 68 ST ESEDRA GA 53 ESEDRA LIGHT 42 / 50 ESEDRA TT 63 / TT 75	PA	100 coppie pairs parejas
--	--	--	--	--	--	--	--	--	--	--	--	--	--	--	----	-----------------------------------

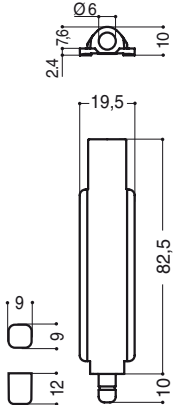
Art. 099992731.0	01												Inox			
099992732.0	01												Zincato			
													<p>Terminale per asta da mm 19,5 con perno inox - zincato</p> <p>19,5 mm rod terminal with stainless steel pin - galvanized</p> <p>Terminal de 19,5 mm con puntal inox - cincado</p>	DOMAL BREAK / GELOSIA / STOPPER PG - GOLD - ALL.CO K40 / 5TT / P4 / EXPORT - EKIP 40 - nuovo new nuovo NC 40	PA	200 Pz

00  
neutro  
neutral  
neutro

01  
nero 9005  
black 9005  
negro 9005

02  
bianco  
white  
blanco

03  
bianco 1013  
white 1013  
blanco 1013

04  
bianco 9010  
white 9010  
blanco 9010

05  
verde  
green  
verde

06  
verde 6005  
green 6005  
verde 6005

07  
marrone  
brown  
marrone

08  
marrone 8017  
brown 8017  
marrone 8017

09  
giallo 1006  
yellow 1006  
amarillo 1006

10  
grigio 7001  
grey 7001  
gris 7001

13  
rosso 3003  
red 3003  
rojo 3003

14  
argento  
silver  
plateado

15  
bronzo  
bronze  
bronce

Art. 099992802.0 01

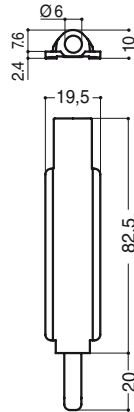

DESCRIZIONE DESCRIPTION DESCRIPCIÓN	APPLICAZIONE APPLICATION APLICACIÓN	MATERIALE MATERIAL MATERIALE	QUANTITÀ QUANTITY QUANTIA
<p>Terminale per asta da mm 19,5 con perno inox da mm 20</p> <p>19,5 mm rod terminal with 20 mm stainless steel pin</p> <p>Terminal de 19,5 mm con puntal inox de 20 mm</p>	<p>DOMAL BREAK / GELOSIA / STOPPER PG - GOLD - ALL.CO K40 / 5TT / P4 / EXPORT - Ekip 40 - nuovo new nuevo NC 40</p>	<p>PA</p>	<p>200 Pz</p>

Art. 099992931.0 01

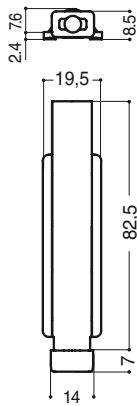

<p>Terminale per asta da mm 19,5 con punta rettangolare da mm 14</p> <p>19,5 mm rod terminal with 14 mm rectangular pin</p> <p>Terminal de 19,5 mm con puntal rectangular de 14 mm</p>	<p>Persiana - shutter persiana KL</p>	<p>PA</p>	<p>200 Pz</p>
--	---------------------------------------	-----------	-------------------

Art. 099992925.0 01

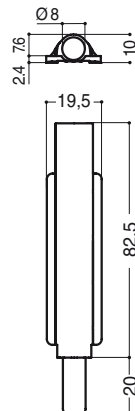

<p>Terminale per asta da mm 19,5 con perno inox Ø 8x20</p> <p>19,5 mm rod terminal with Ø 8x20 stainless steel pin</p> <p>Terminal de 19,5 mm con puntal inox de Ø 8x20</p>		<p>PA</p>	<p>200 Pz</p>
---	--	-----------	-------------------



00	01	02	03	04	05	06	07	08	09	10	13	14	15
neutro neutral neutro	nero 9005 black 9005 negro 9005	bianco white blanco	bianco 1013 white 1013 blanco 1013	bianco 9010 white 9010 blanco 9010	verde green verde	verde 6005 green 6005 verde 6005	marone brown marone	marone 8017 brown 8017 marone 8017	giallo 1006 yellow 1006 amarillo 1006	grigio 7001 grey 7001 gris 7001	rosso 3003 red 3003 rojo 3003	argento silver plateado	bronzo bronze bronce

Art. 099993027.3 01

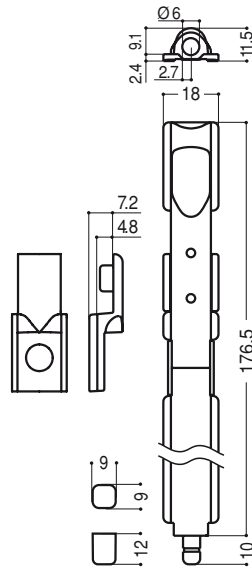

DESCRIZIONE DESCRIPTION DESCRIPCIÓN	APPLICAZIONE APPLICATION APLICACIÓN	MATERIALE MATERIAL MATERIALE	SCATOLA BOX CAJA
<p>Catenaccio da mm 18 con perno zincato e ponte di collegamento per asta</p> <p>18 mm latch with stainless galvanized pin and connection bridge for rod</p> <p>Pasador de 18 mm con puntal cincado y puente de union</p>		PA	50 coppie pairs parejas

Art. 099992744.3 01  
099992745.3 01

Inox

Zincato

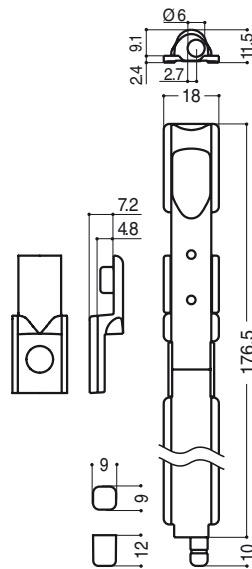

<p>Catenaccio da mm 18 con perno inox - zincato e ponte di collegamento per asta</p> <p>18 mm latch with stainless steel - galvanized pin and connection bridge for rod</p> <p>Pasador de 18 mm con puntal inox - cincado y puente de union</p>	<p>R 40 / R 50 TT / R 62 / R 72 NEW TEC 50 / 52 / 60 / 68 ST ESEDRA GA 53 ESEDRA LIGHT 42 / 50 ESEDRA TT 63 / TT 75</p>	PA	50 coppie pairs parejas
---	---	----	-------------------------------

Art. 099992805.3 01

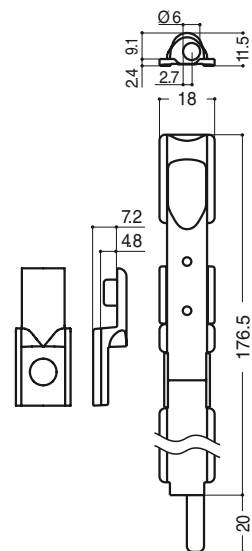

<p>Catenaccio da mm 18 con perno inox da mm 20</p> <p>18 mm latch with 20 mm stainless steel pin</p> <p>Pasador de 18 mm con puntal inox de 20 mm</p>	<p>R 40 / R 50 TT / R 62 / R 72 NEW TEC 50 / 52 / 60 / 68 ST ESEDRA GA 53 ESEDRA LIGHT 42 / 50 ESEDRA TT 63 / TT 75</p>	PA	50 coppie pairs parejas
---	---	----	-------------------------------

16  
 elettro col. nero  
 electrum col. black  
 anodizado col. negro

25  
 marrone 8014  
 brown 8014  
 marrone 8014

26  
 verde 5293  
 gothic 5293  
 verde 5293

37  
 ottone  
 brass  
 ottone

39  
 nero opaco  
 opaque black  
 negro opaco

60  
 verde 5123  
 green 5123  
 verde 5123

68  
 grigio 9006  
 gothic 9006  
 gris 9006

77  
 cromo  
 chrome  
 cromo

MO  
 mogano  
 mahogany  
 caoba

NO  
 noce  
 walnut  
 nogal

RO  
 rovere  
 oak  
 roble

Art. 099992795.3 01

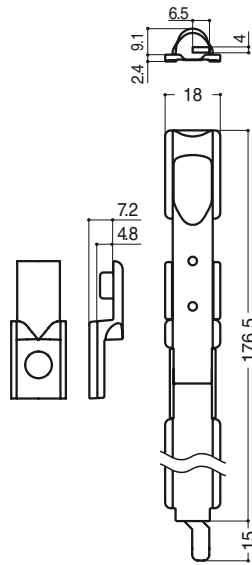

DESCRIZIONE DESCRIPTION DESCRIPCIÓN	APPLICAZIONE APPLICATION APLICACIÓN	MATERIALE MATERIAL MATERIALE	SCATOLA BOX CAJA
<p>Catenaccio da mm 18 con perno zincato piatto e ponte di collegamento per asta cremonese</p> <p>18 mm latch with flat galvanized pin and connection bridge for cremone bolt rod</p> <p>Pasador de 18 mm con puntal cincado plano y puente de unión varilla cremona</p>	<p>R 40 / R 50 TT / R 62 / R 72                      NEW TEC 50 / 52 / 60 / 68 ST                      ESEDRA GA 53                      ESEDRA LIGHT 42 / 50                      ESEDRA TT 63 / TT 75</p>	PA	50 coppie pairs parejas

Art. 099992853.3 01

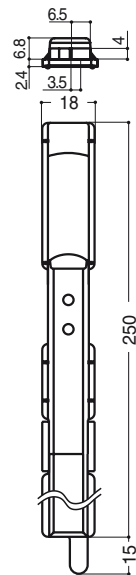

<p>Catenaccio da mm 18 con perno zincato piatto</p> <p>18 mm latch with flat galvanized pin</p> <p>Pasador de 18 mm con puntal cincado plano</p>	<p>R 40 / R 50 TT / R 62 / R 72                      NEW TEC 50 / 52 / 60 / 68 ST                      ESEDRA GA 53                      ESEDRA LIGHT 42 / 50                      ESEDRA TT 63 / TT 75</p>	PA	50 coppie pairs parejas
--	---	----	----------------------------------

Art. 099992900.3 01

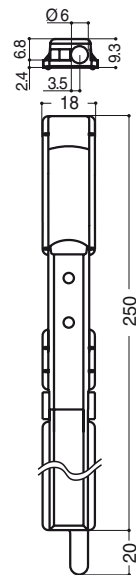

<p>Catenaccio da mm 18 con perno inox da mm 20</p> <p>18 mm latch with 20 mm stainless steel pin</p> <p>Pasador de 18 mm con puntal inox de 20 mm</p>	<p>R 40 / R 50 TT / R 62 / R 72                      NEW TEC 50 / 52 / 60 / 68 ST                      ESEDRA GA 53                      ESEDRA LIGHT 42 / 50                      ESEDRA TT 63 / TT 75</p>	PA	50 coppie pairs parejas
---	---	----	----------------------------------

00	01	02	03	04	05	06	07	08	09	10	13	14	15
neutro neutral neutro	nero 9005 black 9005 negro 9005	bianco white blanco	bianco 1013 white 1013 blanco 1013	bianco 9010 white 9010 blanco 9010	verde green verde	verde 6005 green 6005 verde 6005	marone brown marone	marone 8017 brown 8017 marone 8017	giallo 1006 yellow 1006 amarillo 1006	grigio 7001 grey 7001 gris 7001	rosso 3003 red 3003 rojo 3003	argento silver plateado	bronzo bronze bronce

Art. 099992742.3 01  
099992743.3 01

Inox

Zincato

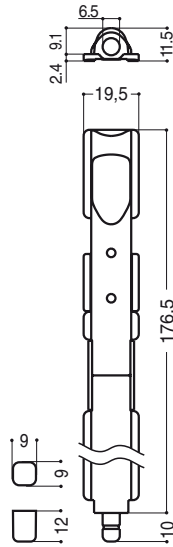

DESCRIZIONE DESCRIPTION DESCRIPCIÓN	APPLICAZIONE APPLICATION APLICACIÓN	MATERIALE MATERIAL MATERIALE	QUANTITÀ QUANTITY QUANTIA
<p>Catenaccio da mm 19,5 con perno inox - zincato</p> <p>19,5 mm latch with stainless - galvanized steel pin</p> <p>Pasador de 19,5 mm con puntal inox - cincado</p>	<p>DOMAL BREAK / GELOSIA / STOPPER PG - GOLD - ALL.CO K40 / 5TT / P4 / EXPORT - EKIP 40 - nuovo new nuovo NC 40</p>	<p>PA</p>	<p>100 coppie pairs parejas</p>

Art. 099992804.3 01

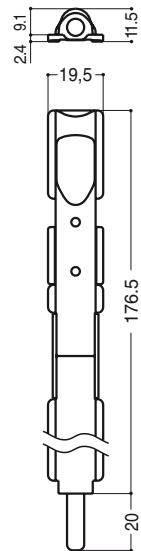

<p>Catenaccio da mm 19,5 con perno inox e asta da mm 20</p> <p>19,5 mm latch with 20 mm stainless steel pin and rod</p> <p>Pasador de 19,5 mm con puntal inox y varilla de 20 mm</p>	<p>DOMAL BREAK / GELOSIA / STOPPER PG - GOLD - ALL.CO K40 / 5TT / P4 / EXPORT - EKIP 40 - nuovo new nuovo NC 40</p>	<p>PA</p>	<p>50 coppie pairs parejas</p>
--	---	-----------	--

Art. 099992904.3 01

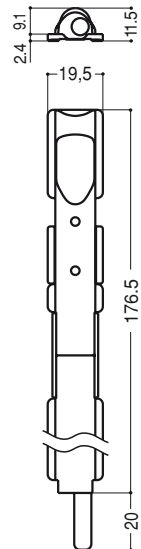

<p>Catenaccio da mm 19,5 con perno inox e asta da mm 20</p> <p>19,5 mm latch with 20 mm stainless steel pin and rod</p> <p>Pasador de 19,5 mm con puntal inox y varilla de 20 mm</p>		<p>PA</p>	<p>50 coppie pairs parejas</p>
--	--	-----------	--

Art. 099992814.0 01



DESCRIZIONE DESCRIPTION DESCRIPCIÓN	APPLICAZIONE APPLICATION APLICACIÓN	MATERIALE MATERIAL MATERIALE	SCATOLA BOX CAJA
Prolunga catenacci Latch extension Extensión pasadores		PA	100 Pz

Art. 099992822.0 01



Kit anta singola One shutter kit Kit una hoja	R 40 / R 50 TT / R 62 / R 72 NEW TEC 50 / 52 / 60 / 68 ST ESEDRA GA 53 ESEDRA LIGHT 42 / 50 ESEDRA TT 63 / TT 75	PA	50 Pz
---	--	----	----------

Art. 099992817.0 01



Kit anta singola One shutter kit Kit una hoja	DOMAL BREAK / GELOSIA / STOPPER PG - GOLD - ALL.CO K40 / 5TT / P4 / EXPORT - EKIP 40 - nuovo new nuovo NC 40	PA	50 Pz
---	--	----	----------



00	01	02	03	04	05	06	07	08	09	10	13	14	15
neutro neutral neutro	nero 9005 black 9005 negro 9005	bianco white blanco	bianco 1013 white 1013 blanco 1013	bianco 9010 white 9010 blanco 9010	verde green verde	verde 6005 green 6005 verde 6005	marone brown marone	marone 8017 brown 8017 marone 8017	giallo 1006 yellow 1006 amarillo 1006	grigio 7001 grey 7001 gris 7001	rosso 3003 red 3003 rojo 3003	argento silver plateado	bronzo bronze bronce

Art. 099992818.0 01



DESCRIZIONE DESCRIPTION DESCRIPCIÓN	APPLICAZIONE APPLICATION APLICACIÓN	MATERIALE MATERIAL MATERIALE	SCATOLA BOX CAJA
Kit due ante Two shutter kit Kit dos hojas	DOMAL BREAK / GELOSIA / STOPPER PG - GOLD - ALL.CO K40 / 5TT / P4 / EXPORT - EKIP 40 - nuovo new nuovo NC 40	PA	30 Pz

Art. 099992842.0 01



Kit anta fissa Fixed shutter kit Kit hoja fija	DOMAL BREAK / GELOSIA / STOPPER PG - GOLD - ALL.CO K40 / 5TT / P4 / EXPORT - EKIP 40 - nuovo new nuovo NC 40	PA	50 Pz
--	--	----	----------

Art. 099992858.0 01

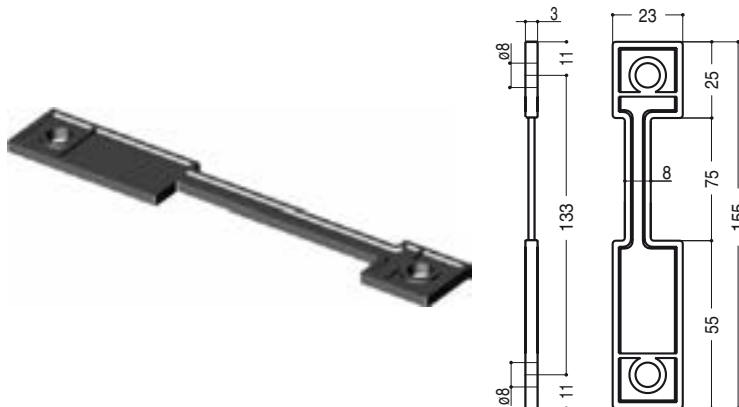

Astina sagomata per catenaccio Shaped rod for latch Varilla moldurada para pasador	DOMAL 40 terza anta - third leaf - 3ª hoja	PA	100 Pz
--	---	----	-----------

16  
 elettro col. nero  
 electrum col. black  
 anodizado col. negro

25  
 marrone 8014  
 brown 8014  
 marrone 8014

26  
 verde 5293  
 gothic 5293  
 verde 5293

37  
 ottone  
 brass  
 ottone

39  
 nero opaco  
 opaque black  
 negro opaco

60  
 verde 5123  
 green 5123  
 verde 5123

68  
 grigio 9006  
 gothic 9006  
 gris 9006

77  
 cromo  
 chrome  
 cromo

MO  
 mogano  
 mahogany  
 caoba

NO  
 noce  
 walnut  
 nogal

RO  
 rovere  
 oak  
 roble

Art. 099992859.0 01

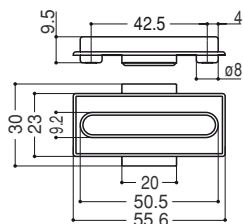

DESCRIZIONE DESCRIPTION DESCRIPCIÓN	APPLICAZIONE APPLICATION APLICACIÓN	MATERIALE MATERIAL MATERIALE	SCATOLA BOX CAJA
Ponte di collegamento per catenaccio Connection bridge for latch Puente de unión para pasador	DOMAL 40 terza anta - third leaf - 3ª hoja	PA	100 Pz

Art. 099992719.0 01

Inox

099992720.0 01

Zincato

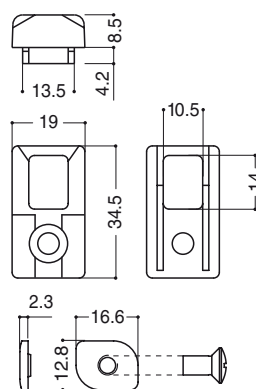

Incontro asta singolo per camera da mm 14 con dado farfalla inox - zincato da mm 16,6 Single match for rod for 14 mm chamber, with 16,6 mm stainless steel - galvanized butterfly nut Encuentro simple varilla para cámara de 14 mm con tuerca de mariposa inox - cincado de 16,6 mm	ABITHAL GREEN - DOMAL STOPPER - DOMAL BREAK - EKV 53 / 64 TT / 72 TT - EXPORT 45 / 45TT / 50 / 50 TT - GOLD 400 - K 40 - SYNTHESIS 45	PA	500 Pz
--	---	----	--------

Art. 099992721.0 01

Inox

099992722.0 01

Zincato

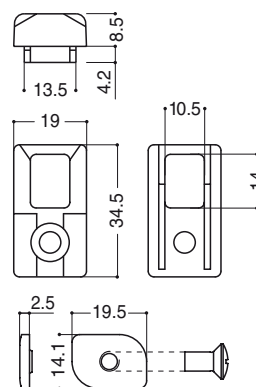

Incontro asta singolo per camera da mm 14 con dado farfalla inox - zincato da mm 19,5 Single match for rod for 14 mm chamber, with 19,5 mm stainless steel - galvanized butterfly nut Encuentro simple varilla para cámara de 14 mm con tuerca de mariposa inox - cincado de 19,5 mm	ALL.CO 5 ALPHA 445 / 658 TT EKV 40 / 50 - EURO 40 nuovo - new - nuevo NC 40	PA	500 Pz
--	--	----	--------

Art. 099992926.0 01

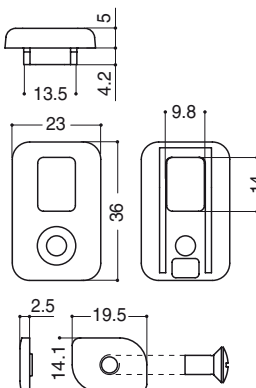

Incontro asta singolo basso per camera da mm 14 con dado farfalla inox da mm 19,5 Low single match for rod for 14 mm chamber, with 19,5 mm stainless steel butterfly nut Encuentro simple inferior varilla para cámara de 14 mm con tuerca de mariposa inox de 19,5 mm	Persiana - shutter persiana KL	PA	500 Pz
--	-----------------------------------	----	--------

Versione dado farfalla zincato su richiesta  
 Version of galvanized butterfly nut upon request  
 Tuerca de mariposa versión cincada bajo pedido

00	01	02	03	04	05	06	07	08	09	10	13	14	15
neutro neutral neutro	nero 9005 black 9005 negro 9005	bianco white blanco	bianco 1013 white 1013 blanco 1013	bianco 9010 white 9010 blanco 9010	verde green verde	verde 6005 green 6005 verde 6005	marone brown marone	marone 8017 brown 8017 marone 8017	giallo 1006 yellow 1006 amarillo 1006	grigio 7001 grey 7001 gris 7001	rosso 3003 red 3003 rojo 3003	argento silver plateado	bronzo bronze bronce

				DESCRIZIONE DESCRIPTION DESCRIPCIÓN	APPLICAZIONE APPLICATION APLICACIÓN	MATERIALE MATERIAL MATERIALE	SCATOLA BOX CAJA	
Art. 099992969.0	01			<p>Incontro asta doppio basso per camera da mm 14 con dado farfalla inox da mm 19,5</p> <p>Low double match for rod for 14 mm chamber, with 19,5 mm stainless steel butterfly nut</p> <p>Encuentro doble inferior varilla para cámara de 14 mm con tuerca de mariposa inox de 19,5 mm</p>	Persiana - shutter persiana KL	PA	500 Pz	
Art. 099992723.0	01			Inox	<p>Incontro asta doppio per camera da mm 14 con dado farfalla inox - zincato da mm 16,6</p> <p>Double match for rod for 14 mm chamber, with 16,6 mm stainless steel - galvanized butterfly nut</p> <p>Encuentro doble varilla para cámara de 14 mm con tuerca de mariposa inox - cincado de 16,6 mm</p>	ABITHAL GREEN DOMAL STOPPER DOMAL BREAK EKU 53 / 64 TT / 72 TT EXPORT 45 / 45TT / 50 / 50 TT GOLD 400 - K 40 SYNTHESIS 45	PA	500 Pz
099992724.0	01			Zincato				
Art. 099992725.1	01			Dx	<p>Incontro asta dx - sx per camera da mm 15 con dado farfalla inox da mm 19,5</p> <p>Right - left match for rod for 15 mm chamber, with 19,5 mm stainless steel butterfly nut</p> <p>Encuentro dch - izd varilla para cámara de 15 mm con tuerca de mariposa inox de 19,5 mm</p>	SISTEMA I nuovo new nuovo NC 40	PA	500 Pz
099992725.2	01			Sx				
Art. 099992726.1	01			Dx	<p>Incontro asta dx - sx per camera da mm 15 con dado farfalla zincato da mm 19,5</p> <p>Right - left match for rod for 15 mm chamber, with 19,5 mm galvanized butterfly nut</p> <p>Encuentro dch - izd varilla para cámara de 15 mm con tuerca de mariposa cincada de 19,5 mm</p>	SISTEMA I nuovo new nuovo NC 40	PA	500 Pz
099992726.2	01			Sx				

16  
 eletto col. nero  
 electrum col. black  
 anodizado col. negro

25  
 marrone 8014  
 brown 8014  
 marrone 8014

26  
 verde 5293  
 gothic 5293  
 verde 5293

37  
 ottone  
 brass  
 ottone

39  
 nero opaco  
 opaque black  
 negro opaco

60  
 verde 5123  
 green 5123  
 verde 5123

68  
 grigio 9006  
 gothic 9006  
 gris 9006

77  
 cromo  
 chrome  
 cromo

MO  
 mogano  
 mahogany  
 caoba

NO  
 noce  
 walnut  
 nogal

RO  
 rovere  
 oak  
 roble

Art. 099990095.0 01

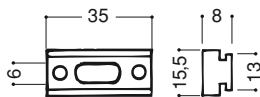

DESCRIZIONE DESCRIPTION DESCRIPCIÓN	APPLICAZIONE APPLICATION APLICACION	MATERIALE MATERIAL MATERIALE	SCATOLA BOX CAJA
<p>Riscontro regolabile per astina Ø 6</p> <p>Adjustable striker for Ø 6 rod</p> <p>Cerradero ajustable para varilla Ø 6</p>		PA	500 Pz

Art. 099992812.0 01

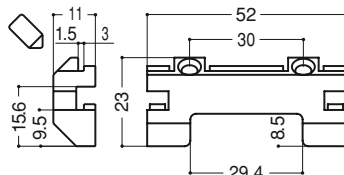

<p>Incontro asta doppio con 2 grani inox</p> <p>Double match for rod with 2 stainless steel grains</p> <p>Encuentro doble varilla con 2 clavijas inox</p>	<p>ALL.CO 5 / 5 TT - R 40 / 50 TT / R 62 / R 72</p> <p>NEW TEC 50 / 52 / 60 / 68 ST</p> <p>ESEDRA GA 53</p> <p>ESEDRA LIGHT 42 / 50</p> <p>ESEDRA TT 63 / TT 75</p>	PA	500 Pz
---	---	----	--------

Art. 099992924.0 01

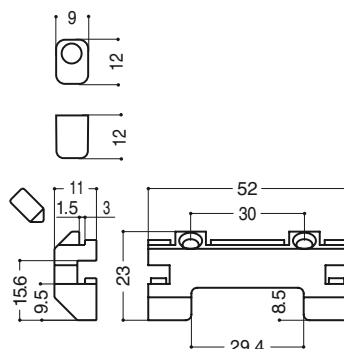

<p>Incontro asta con 2 grani inox e 2 boccole</p> <p>Match for rod with 2 stainless steel grains and 2 bushings</p> <p>Encuentro varilla con 2 clavijas inox y 2 casquillos</p>	<p>ALL.CO 5S / 5STT</p>	PA	100 Pz
---	-------------------------	----	--------

Art. 699992619.0 01

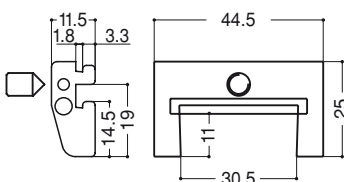

<p>Incontro asta con rullino inox</p> <p>Match for rod with stainless steel grains</p> <p>Encuentro varilla con rodillo inox</p>	<p>R 40 / 50 TT / R 62 / R 72</p> <p>NEW TEC 50 / 52 / 60 / 68 ST</p> <p>ESEDRA GA 53</p> <p>ESEDRA LIGHT 42 / 50</p> <p>ESEDRA TT 63 / TT 75</p>	PA	500 Pz
--	---	----	--------

00  
neutro  
neutral  
neutro

01  
nero 9005  
black 9005  
negro 9005

02  
bianco  
white  
blanco

03  
bianco 1013  
white 1013  
blanco 1013

04  
bianco 9010  
white 9010  
blanco 9010

05  
verde  
green  
verde

06  
verde 6005  
green 6005  
verde 6005

07  
marrone  
brown  
marrone

08  
marrone 8017  
brown 8017  
marrone 8017

09  
giallo 1006  
yellow 1006  
amarillo 1006

10  
grigio 7001  
grey 7001  
gris 7001

13  
rosso 3003  
red 3003  
rojo 3003

14  
argento  
silver  
plateado

15  
bronz  
bronze  
bronce

Art. 099992789.0 01

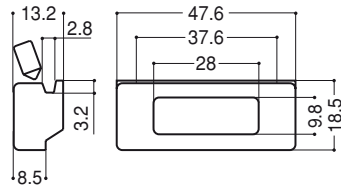

DESCRIZIONE  
DESCRIPTION  
DESCRIPCIÓN

Incontro asta doppio  
con 2 grani inox  
Double match for rod with  
2 stainless steel grains  
Encuentro doble varilla  
con 2 clavijas inox

APPLICAZIONE  
APPLICATION  
APLICACIÓN

EXPORT - EKU - GOLD

MATERIALE  
MATERIAL  
MATERIALE

PA

SCATOLA  
BOX  
CAJA

500  
Pz

Art. 099992790.0 01

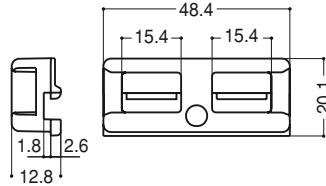

Incontro asta doppio  
con 1 grano inox  
Double match for rod with  
1 stainless steel grain  
Encuentro doble varilla  
con 1 clavija inox

SISTEMA 1  
nuovo - new - nuovo NC 40

PA

500  
Pz

Art. 099993021.0 01

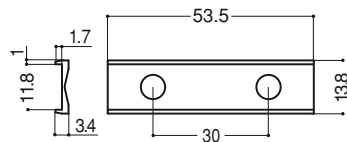

Supporto gancio telaio  
perimetrale  
Bracket adapter for  
perimeter frame  
Soporte gancho marco  
perimetral

PA

1.000  
Pz

Art. 099993022.0 01

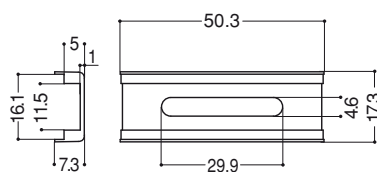

Distanziale anta  
s/tradizionale  
mm 17,3x7,3  
Shutter spacer s/  
traditional 17,3 x7,3 mm  
Distanciador hoja  
S/tradicionales  
17,3x7,3 mm

PA

1.000  
Pz

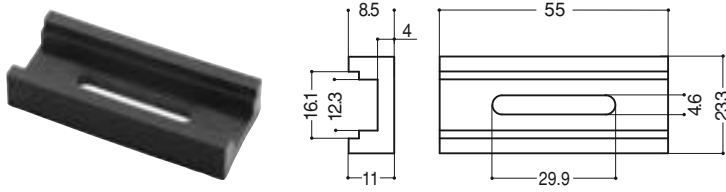
Art. 099993023.0 01	DESCRIZIONE DESCRIPTION DESCRIPCIÓN	APPLICAZIONE APPLICATION APLICACIÓN	MATERIALE MATERIAL MATERIAL	SCATOLA BOX CAJA
	<p>Distanziale anta mm 23,3x14 Shutter spacer 23,3 x14 mm Distanciador hoja 23,3x14 mm</p>		PA	250 Pz
	<p>Distanziale anta mm 23,3x11 Shutter spacer 23,3 x11 mm Distanciador hoja 23,3x11 mm</p>		PA	250 Pz
	<p>Distanziale anta mm 27,7x10,2 Shutter spacer 27,7x10,2 mm Distanciador hoja 27,7x10,2 mm</p>		PA	250 Pz
	<p>Supporto gancio telaio aperto mm 9,8x10 Bracket adapter for open frame 9,8 x 10 mm Soporte gancho marco abierto 9,8x10 mm</p>		PA	250 Pz
	<p>Supporto gancio telaio aperto mm 7x12 Bracket adapter for open frame 9,8 x 10 mm Soporte gancho marco abierto 7x12 mm</p>		PA	250 Pz



# MANIGLIE E MANIGLIONI



HANDLES  
AND PULL HANDLE

MANILLAS  
Y TIRADORES





00  
neutro  
neutral  
neutro

01  
nero 9005  
black 9005  
negro 9005

02  
bianco  
white  
blanco

03  
bianco 1013  
white 1013  
blanco 1013

04  
bianco 9010  
white 9010  
blanco 9010

05  
verde  
green  
verde

06  
verde 6005  
green 6005  
verde 6005

07  
marrone  
brown  
marrone

08  
marrone 8017  
brown 8017  
marrone 8017

09  
giallo 1006  
yellow 1006  
amarillo 1006

10  
grigio 7001  
grey 7001  
gris 7001

13  
rosso 3003  
red 3003  
rojo 3003

14  
argento  
silver  
plateado

15  
bronzo  
bronze  
bronce

Art. 099992748.0 01 03 04  
099992747.0 01 03 04

Lucida  
Opaca

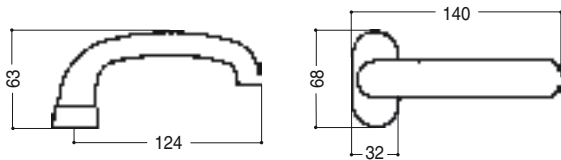

DESCRIZIONE  
DESCRIPTION  
DESCRIPCIÓN

MATERIALE  
MATERIAL  
MATERIALE

SCATOLA  
BOX  
CAJA

Maniglia **CRISTINA** in resina LUCIDA - OPACA  
con borchia ovale e molla di ritorno (Brevettata)  
**CRISTINA** handle in BRIGHT - MATT resin with oval boss  
and return spring (Patented) Manilla  
**CRISTINA** en resina BRILLANTE - MATE  
con escudo oval y muelle de recuperación (Patentada)

PA

10  
coppie  
pairs  
parejas

Art. 099992756.0 01 03 04  
099992755.0 01 03 04

Lucida  
Opaca

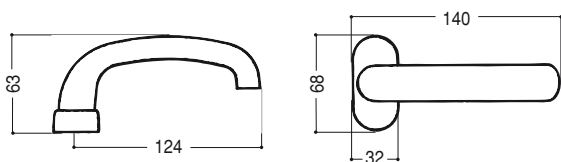

Maniglia **CRISTINA** in resina LUCIDA - OPACA  
con borchia ovale senza molla di ritorno (Brevettata)  
**CRISTINA** handle in BRIGHT - MATT resin  
with oval boss without return spring (Patented)  
Manilla **CRISTINA** en resina BRILLANTE - MATE  
con escudo oval sin muelle de recuperación (Patentada)

PA

10  
coppie  
pairs  
parejas

16

eletto col. nero  
electron col. black  
anodizado col. negro

25

marrone 8014  
brown 8014  
marrone 8014

26

verde 5293  
gothic 5293  
verde 5293

37

ottone  
brass  
ottone

39

nero opaco  
opaque black  
negro opaco

60

verde 5123  
green 5123  
verde 5123

68

grigio 9006  
gothic 9006  
gris 9006

77

cromo  
chrome  
cromo

MO

mogano  
mahogany  
caoba

NO

noce  
walnut  
nogal

RO

rovere  
oak  
roble

Art. 099991912.0 01 03 04  
099991903.0 01 03 04

Lucida  
Opaca

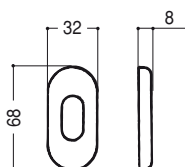

DESCRIZIONE DESCRIPTION DESCRIPCIÓN	MATERIALE MATERIAL MATERIALE	SCATOLA BOX CAJA
<p>Borchia ovale in resina LUCIDA - OPACA per cilindro ovale serie <b>CRISTINA</b></p> <p>Oval boss in BRIGHT - MATT resin for oval cylinder of <b>CRISTINA</b> series</p> <p>Escudo oval en resina BRILLANTE - MATE para bombin oval serie <b>CRISTINA</b></p>	PA	

Art. 099991908.0 01 03 04  
099991881.0 01 03 04

Lucida  
Opaca

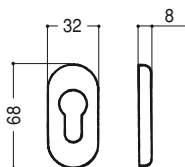

<p>Borchia ovale in resina LUCIDA - OPACA per cilindro sagomato serie <b>CRISTINA</b></p> <p>Oval boss in BRIGHT - MATT resin for shaped cylinder of <b>CRISTINA</b> series</p> <p>Escudo oval en resina BRILLANTE - MATE para bombin moldeado serie <b>CRISTINA</b></p>	PA	
--	----	--

Art. 099992750.0 01 03 04  
099992749.0 01 03 04

Lucida  
Opaca

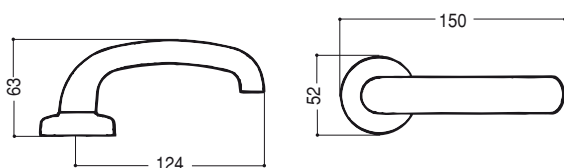

<p>Maniglia <b>CRISTINA</b> in resina LUCIDA - OPACA con borchia tonda e molla di ritorno (Brevettata)</p> <p><b>CRISTINA</b> handle in BRIGHT - MATT resin with round boss and return spring (Patented)</p> <p>Manilla <b>CRISTINA</b> en resina BRILLANTE - MATE con escudo redondo y muelle de recuperación (Patentada)</p>	PA	10 coppie pairs parejas
--	----	----------------------------------



16  
eletto col. nero  
electrum col. black  
anodizado col. negro

25  
marrone 8014  
brown 8014  
marrone 8014

26  
verde 5293  
gothic 5293  
verde 5293

37  
ottone  
brass  
ottone

39  
nero opaco  
opaque black  
negro opaco

60  
verde 5123  
green 5123  
verde 5123

68  
grigio 9006  
gothic 9006  
gris 9006

77  
cromo  
chrome  
cromo

MO  
mogano  
mahogany  
caoba

NO  
noce  
walnut  
nogal

RO  
rovere  
oak  
roble

Art. 099992753.0 01 03 04 39

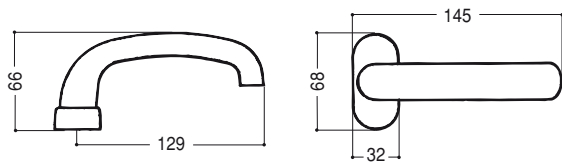

DESCRIZIONE  
DESCRIPTION  
DESCRIPCIÓN

MATERIALE  
MATERIAL  
MATERIALE

SCATOLA  
BOX  
CAJA

Maniglia **CRISTINA** in alluminio con borchia ovale e molla di ritorno (Brevettata)  
**CRISTINA** handle in aluminium with oval boss and return spring (Patented)  
Manilla **CRISTINA** en aluminio con escudo oval y muelle de recuperación (Patentada)

AL

10  
coppie  
pairs  
parejas

Art. 099992937.0 01 03 04 39

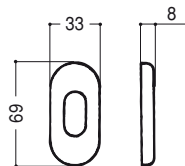

Borchia ovale in alluminio per cilindro ovale serie **CRISTINA**  
Oval boss in aluminium for oval cylinder of **CRISTINA** series  
Escudo oval en aluminio para bombín oval serie **CRISTINA**

PA  
AL

Art. 099992938.0 01 03 04 39

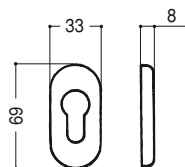

Borchia ovale in alluminio per cilindro sagomato serie **CRISTINA**  
Oval boss in aluminium for shaped cylinder of **CRISTINA** series  
Escudo oval en aluminio para bombín moldeado serie **CRISTINA**

PA  
AL

Art. 099992939.0 01 03 04 39

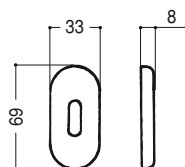

Borchia ovale in alluminio per chiave PATENT serie **CRISTINA**  
Oval boss in aluminium for PATENT key of **CRISTINA** series  
Escudo oval en aluminio para llave PATENT serie **CRISTINA**

PA  
AL

00 neutro neutral neutro	01 nero 9005 black 9005 negro 9005	02 bianco white blanco	03 bianco 1013 white 1013 blanco 1013	04 bianco 9010 white 9010 blanco 9010	05 verde green verde	06 verde 6005 green 6005 verde 6005	07 marrone brown marrone	08 marrone 8017 brown 8017 marrone 8017	09 giallo 1006 yellow 1006 amarillo 1006	10 grigio 7001 grey 7001 gris 7001	13 rosso 3003 red 3003 rojo 3003	14 argento silver plateado	15 bronzo bronze bronce
-----------------------------------	---	---------------------------------	--	--	-------------------------------	--	-----------------------------------	--	---	---	---	-------------------------------------	----------------------------------

Art. 099992754.0 01 03 04 39

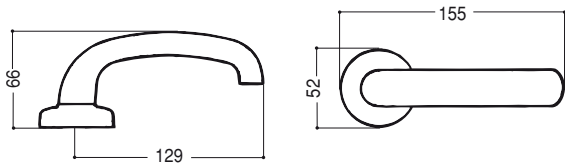

DESCRIZIONE  
DESCRIPTION  
DESCRIPCIÓN

MATERIALE  
MATERIAL  
MATERIALE

SCATOLA  
BOX  
CAJA

Maniglia **CRISTINA** in alluminio con borchia tonda e molla di ritorno (Brevettata)

**CRISTINA** handle in aluminium with round boss and return spring (Patented)

Manilla **CRISTINA** en aluminio con escudo redondo y muelle de recuperación (Patentada)

AL

10  
coppie  
pairs  
parejas

Art. 099992091.0 01 03 04 39

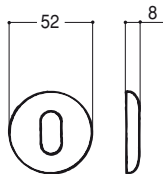

Borchia tonda in alluminio per cilindro ovale serie **CRISTINA**

Round boss in aluminium for oval cylinder of **CRISTINA** series

Escudo redondo en aluminio para bombín oval serie **CRISTINA**

PA  
AL

Art. 099992092.0 01 03 04 39

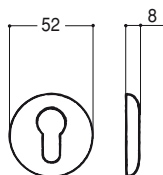

Borchia tonda in alluminio per cilindro sagomato serie **CRISTINA**

Round boss in aluminium for shaped cylinder of **CRISTINA** series

Escudo redondo en aluminio para bombín moldeado serie **CRISTINA**

PA  
AL

Art. 099992093.0 01 03 04 39

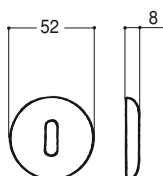

Borchia tonda in alluminio per chiave PATENT serie **CRISTINA**

Round boss in aluminium for PATENT key of **CRISTINA** series

Escudo redondo en aluminio para llave PATENT serie **CRISTINA**

PA  
AL

16

eletto col. nero  
electrum col. black  
anodizado col. negro

25

marrone 8014  
brown 8014  
marrone 8014

26

verde 5293  
gothic 5293  
verde 5293

37

ottone  
brass  
ottone

39

nero opaco  
opaque black  
negro opaco

60

verde 5123  
green 5123  
verde 5123

68

grigio 9006  
gothic 9006  
gris 9006

77

cromo  
chrome  
cromo

MO

mogano  
mahogany  
caoba

NO

noce  
walnut  
nogal

RO

rovere  
oak  
roble

Art. 099992021.0 01 03 04 39

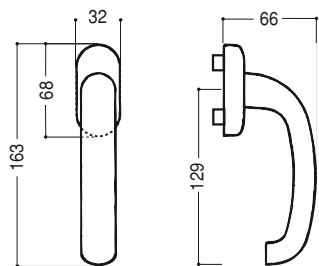

DESCRIZIONE  
DESCRIPTION  
DESCRIPCIÓN

MATERIALE  
MATERIAL  
MATERIALE

SCATOLA  
BOX  
CAJA

Martellina **CRISTINA** in alluminio  $\varnothing$  7  
**CRISTINA** cremone bolt handle in aluminium  $\varnothing$  7  
Martellina **CRISTINA** en aluminio  $\varnothing$  7

AL

20  
Pz

Art. 099992960.0 01 03 04

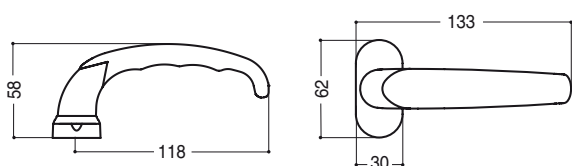

Maniglia **NUOVA EMOZIONE** in resina con  
borchia ovale  
**NUOVA EMOZIONE** handle in resin, with oval  
boss  
Manilla **NUOVA EMOZIONE** en resina con escudo oval

PA

10  
coppie  
pairs  
parejas

00  
neutro  
neutral  
neutro

01  
nero 9005  
black 9005  
negro 9005

02  
bianco  
white  
blanco

03  
bianco 1013  
white 1013  
blanco 1013

04  
bianco 9010  
white 9010  
blanco 9010

05  
verde  
green  
verde

06  
verde 6005  
green 6005  
verde 6005

07  
marrone  
brown  
marrone

08  
marrone 8017  
brown 8017  
marrone 8017

09  
giallo 1006  
yellow 1006  
amarillo 1006

10  
grigio 7001  
grey 7001  
gris 7001

13  
rosso 3003  
red 3003  
rojo 3003

14  
argento  
silver  
plateado

15  
bronzo  
bronze  
bronce

Art. 099992957.0 01 03 04

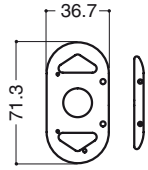

Spessore per maniglie serie **CRISTINA** con borchia ovale e maniglie **TATA** per profili arrotondati

Thickness for handles of **CRISTINA** series with oval boss and **TATA** handles for rounded profiles

Espesor para manillas serie **CRISTINA** con escudo oval y manillas **TATA** para perfiles redondeados

PA

Art. 099992751.0 01 03 04

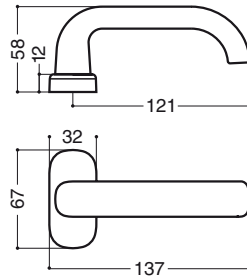

Maniglia **TATA** in resina con molla di ritorno

**TATA** handle in resin with return spring

Manilla **TATA** en resina con muelle de recuperación

PA

10  
coppie  
pairs  
parejas

Art. 099992759.0 01 03 04

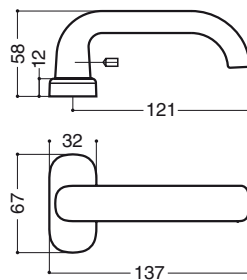

Maniglia **TATA** in resina con grano e molla di ritorno

**TATA** handle in resin with grain and return spring

Manilla **TATA** en resina con clavija y muelle de recuperación

PA

10  
coppie  
pairs  
parejas

Art. 099992098.0 01 03 04

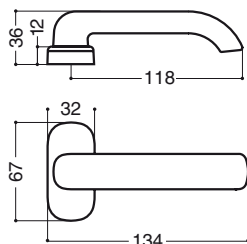

Maniglia **TATA** in resina ribassata con molla di ritorno

**TATA** handle in recessed resin with return spring

Manilla **TATA** en resina rebajada con muelle de recuperación

PA

20  
coppie  
pairs  
parejas

16  
 eletto col. nero  
 electrum col. black  
 anodizado col. negro

25  
 marrone 8014  
 brown 8014  
 marrone 8014

26  
 verde 5293  
 gothic 5293  
 verde 5293

37  
 ottone  
 brass  
 ottone

39  
 nero opaco  
 opaque black  
 negro opaco

60  
 verde 5123  
 green 5123  
 verde 5123

68  
 grigio 9006  
 gothic 9006  
 gris 9006

77  
 cromo  
 chrome  
 cromo

MO  
 mogano  
 mahogany  
 caoba

NO  
 noce  
 walnut  
 nogal

RO  
 rovere  
 oak  
 roble

Art. 099992119.0 01 03 04

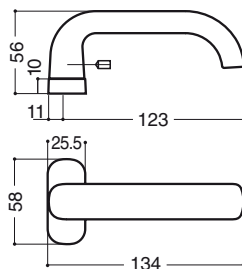

DESCRIZIONE  
 DESCRIPTION  
 DESCRIPCIÓN

Maniglia **TATA** in resina decentrata  
**TATA** handle in decentered resin  
 Manilla **TATA** en resina descentrada

MATERIALE  
 MATERIAL  
 MATERIALE

PA

SCATOLA  
 BOX  
 CAJA

20  
 coppie  
 pairs  
 parejas

Art. 099992132.0 01 03 04

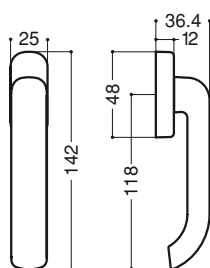

Maniglia **TATA** in resina con leva bassa per serratura persiana  
**TATA** handle in resin with low lever for shutter lock  
 Manilla **TATA** en resina con maneta baja para cierre persiana

PA

50  
 Pz

Art. 099992815.0 01 03 04

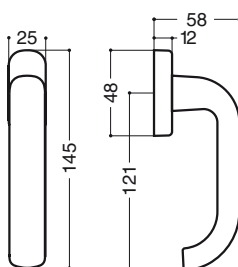

Maniglia **TATA** in resina con leva alta per serratura persiana  
**TATA** handle in resin with high lever for shutter lock  
 Manilla **TATA** en resina con maneta alta para cierre persiana

PA

25  
 Pz

Art. 099992157.0 01 03 04

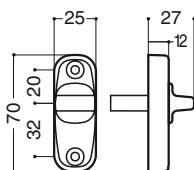

Comando chiusura persiana serie **TATA** in resina con quadro mm 6 x 82  
 Control for shutter lock in resin of **TATA** series with 6 x 82 mm frame  
 Mando cierre persiana serie **TATA** en resina con cuadradillo 6x82 mm

PA

50  
 Pz



00  
neutro  
neutral  
neutro

01  
nero 9005  
black 9005  
negro 9005

02  
bianco  
white  
blanco

03  
bianco 1013  
white 1013  
blanco 1013

04  
bianco 9010  
white 9010  
blanco 9010

05  
verde  
green  
verde

06  
verde 6005  
green 6005  
verde 6005

07  
marrone  
brown  
marrone

08  
marrone 8017  
brown 8017  
marrone 8017

09  
giallo 1006  
yellow 1006  
amarillo 1006

10  
grigio 7001  
grey 7001  
gris 7001

13  
rosso 3003  
red 3003  
rojo 3003

14  
argento  
silver  
plateado

15  
bronz  
bronze  
bronce

Art. 099992192.0 01 03 04

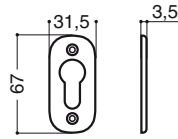

DESCRIZIONE  
DESCRIPTION  
DESCRIPCIÓN

MATERIALE  
MATERIAL  
MATERIALE

SCATOLA  
BOX  
CAJA

Borchia ovale in resina per cilindro sagomato serie **TATA**  
Oval boss in resin for shaped cylinder of **TATA** series  
Escudo oval en resina para bombín moldeado serie **TATA**

PA

50  
Pz

Art. 099992768.0 01 03 04

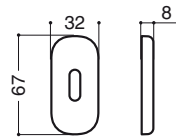

Borchia ovale in resina per chiave PATENT serie **TATA**  
Oval boss in resin for PATENT key of **TATA** series  
Escudo oval en resina para llave PATENT serie **TATA**

PA

50  
Pz

Art. 099990081.0 01 03 04

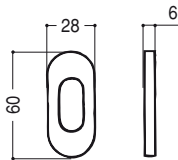

Borchia ovale per cilindro ovale  
Oval boss for oval cylinder  
Escudo oval para bombín oval

PA

50  
Pz

Art. 099990094.0 01 03 04

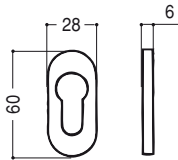

Borchia ovale per cilindro sagomato  
Oval boss for shaped cylinder  
Escudo oval para bombín moldeado

PA

50  
Pz

Art. 099990096.0 01

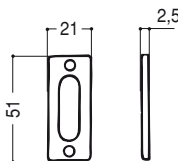

Borchia sottile per cilindro ovale  
Thin boss for oval cylinder  
Escudo fino para bombín oval

PA

100  
Pz

Art. 099990082.0 01

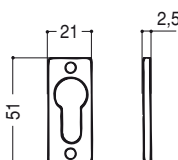

Borchia sottile per cilindro sagomato  
Thin boss for shaped cylinder  
Escudo fino para bombín moldeado

PA

100  
Pz

16  
 eletto col. nero  
 electrum col. black  
 anodizado col. negro

25  
 marrone 8014  
 brown 8014  
 marrone 8014

26  
 verde 5293  
 gothic 5293  
 verde 5293

37  
 ottone  
 brass  
 ottone

39  
 nero opaco  
 opaque black  
 negro opaco

60  
 verde 5123  
 green 5123  
 verde 5123

68  
 grigio 9006  
 gothic 9006  
 gris 9006

77  
 cromo  
 chrome  
 cromo

MO  
 mogano  
 mahogany  
 caoba

NO  
 noce  
 walnut  
 nogal

RO  
 rovere  
 oak  
 roble

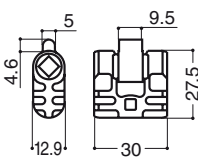
Art. 099992125.0 01	DESCRIZIONE DESCRIPTION DESCRIPCIÓN	MATERIALE MATERIAL MATERIALE	SCATOLA BOX CAJA
 	<p>Borchia sottile per chiave patent                      Thin boss for patent key                      Escudo fino para llave Patent</p>	PA	100 Pz
 	<p>Blocchetto libero-occupato con quadro mm 6 x 82                      Vacant - engaged lock 6 x 82 mm frame                      Cierre libre-ocupado con cuadradillo 6x82 mm</p>	PA	50 Pz
 	<p>Cilindro di adattamento ovale (serrature CISA e similari)                      Oval adaptation cylinder (CISA locks and similar)                      Bombín de adaptación oval (cerraduras CISA y similares)</p>	PA	50 Pz
 	<p>Cilindro di adattamento ovale                      Oval adaptation cylinder                      Bombín de adaptación oval</p>	PA	50 Pz
 	<p>Cilindro di adattamento sagomato                      Shaped adaptation cylinder                      Bombín de adaptación moldeado</p>	PA	50 Pz
 	<p>Riduzione quadro serratura da mm 8 a mm 6                      Lock frame reduction from 8 mm to 6 mm                      Reducción cuadradillo cerradura de 8 a 6 mm</p>	PA	50 Pz

00	01	02	03	04	05	06	07	08	09	10	13	14	15
neutro neutral neutro	nero 9005 black 9005 negro 9005	bianco white blanco	bianco 1013 white 1013 blanco 1013	bianco 9010 white 9010 blanco 9010	verde green verde	verde 6005 green 6005 verde 6005	marone brown marone	marone 8017 brown 8017 marone 8017	giallo 1006 yellow 1006 amarillo 1006	grigio 7001 grey 7001 gris 7001	rosso 3003 red 3003 rojo 3003	argento silver plateado	bronzo bronze bronce

Art. 099990080.0 01 03 04 14 15 16

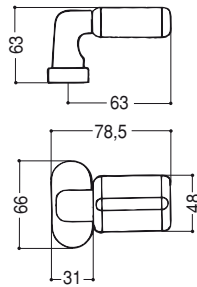

DESCRIZIONE DESCRIPTION DESCRIPCIÓN	MATERIALE MATERIAL MATERIALE	SCATOLA BOX CAJA
Pomolo <b>PEGASO</b> in alluminio con borchia ovale <b>PEGASO</b> knob in aluminium with oval boss Pomo <b>PEGASO</b> en aluminio con escudo oval	PA AL	10 coppie pairs parejas

Art. 099990049.0 01 03 04 14 15 16

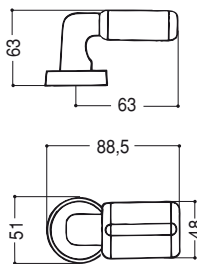

Pomolo <b>PEGASO</b> in alluminio con borchia tonda <b>PEGASO</b> knob in aluminium with round boss Pomo <b>PEGASO</b> en aluminio con escudo redondo	PA AL	10 coppie pairs parejas
---	----------	----------------------------------

Art. 099990815.0 01

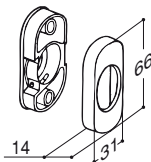

Kit borchia ovale per pomolo <b>PEGASO</b> per montante Kit for oval boss for <b>PEGASO</b> knob for leg Kit escudo oval pomo <b>PEGASO</b> para montante POM	PA	2 Pz
---	----	---------

Art. 099990814.0 01

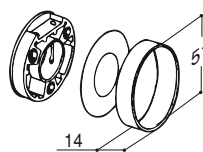

Kit borchia tonda per pomolo <b>PEGASO</b> per fascia Kit for round boss for <b>PEGASO</b> knob for band Kit escudo redondo pomo <b>PEGASO</b> para montante POM	PA	2 Pz
--	----	---------

16  
 elettro col. nero  
 electrum col. black  
 anodizado col. negro

25  
 marrone 8014  
 brown 8014  
 marrone 8014

26  
 verde 5293  
 gothic 5293  
 verde 5293

37  
 ottone  
 brass  
 ottone

39  
 nero opaco  
 opaque black  
 negro opaco

60  
 verde 5123  
 green 5123  
 verde 5123

68  
 grigio 9006  
 gothic 9006  
 gris 9006

77  
 cromo  
 chrome  
 cromo

MO  
 mogano  
 mahogany  
 caoba

NO  
 noce  
 walnut  
 nogal

RO  
 rovere  
 oak  
 roble

		DESCRIZIONE DESCRIPTION DESCRIPCIÓN	MATERIALE MATERIAL MATERIALE	SCATOLA BOX CAJA
Art. 310008800.0	11	X = mm 80		
3100081000.0	11	X = mm 100		
3100081300.0	11	X = mm 130		
		Asta AVP $\varnothing$ 8 AVP $\varnothing$ 8 rod Varilla AVP $\varnothing$ 8	ACC	
Art. 099990044.0	01 03 04 14 15 16			
		Maniglione trafilato piccolo in alluminio da mm 160 con borchia ovale Small drawn bar in aluminium, 160 mm, with oval boss Tirador trefilado pequeño en aluminio de 160 mm con escudo oval	PA AL	20 Pz
Art. 099990040.0	01 03 04 14 15 16			
		Maniglione trafilato piccolo in alluminio da mm 160 con borchia tonda Small drawn bar in aluminium, 160 mm, with round boss Tirador trefilado pequeño en aluminio de 160 mm con escudo redondo	PA AL	20 Pz
Art. 099990045.0	01 03 04 14 15 16			
		Maniglione trafilato piccolo in alluminio da mm 270 con borchia ovale Small drawn bar in aluminium, 270 mm, with oval boss Tirador trefilado pequeño en aluminio de 270 mm con escudo oval	PA AL	

<b>00</b> neutro neutral neutro	<b>01</b> nero 9005 black 9005 negro 9005	<b>02</b> bianco white blanco	<b>03</b> bianco 1013 white 1013 blanco 1013	<b>04</b> bianco 9010 white 9010 blanco 9010	<b>05</b> verde green verde	<b>06</b> verde 6005 green 6005 verde 6005	<b>07</b> marrone brown marrone	<b>08</b> marrone 8017 brown 8017 marrone 8017	<b>09</b> giallo 1006 yellow 1006 amarillo 1006	<b>10</b> grigio 7001 grey 7001 gris 7001	<b>13</b> rosso 3003 red 3003 rojo 3003	<b>14</b> argento silver plateado	<b>15</b> bronzo bronze bronce
--	--	--	---	---	--------------------------------------	---	--	---	--	--	--	--	---

**Art. 099990041.0** 01 03 04 14 15 16

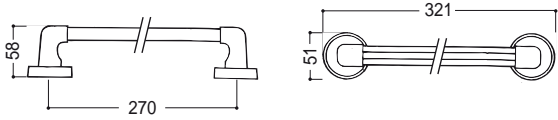

DESCRIZIONE  
DESCRIPTION  
DESCRIPCIÓN

MATERIALE  
MATERIAL  
MATERIALE

SCATOLA  
BOX  
CAJA

Maniglione trafilato piccolo in alluminio da mm 270 con borchia tonda  
Small drawn bar in aluminium, 270 mm, with round boss  
Tirador trafilado pequeño en aluminio de 270 mm con escudo redondo

PA  
AL

**Art. 099990046.0** 01 03 04 14 15 16

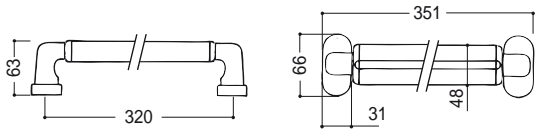

Maniglione profilato grande in alluminio da mm 320 con borchia ovale  
Small drawn bar in aluminium, 320 mm, with oval boss  
Tirador perfilado grande en aluminio de 320 mm con escudo oval

PA  
AL

**Art. 099990043.0** 01 03 04 14 15 16

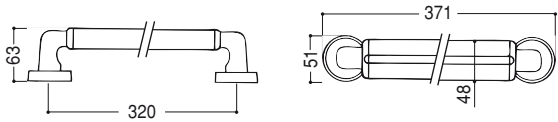

Maniglione profilato grande in alluminio da mm 320 con borchia tonda  
Small drawn bar in aluminium, 320 mm, with round boss  
Tirador perfilado grande en aluminio de 320 mm con escudo redondo

PA  
AL

**Art.**

**16**  
elettro col. nero  
electrum col. black  
anodizado col. negro

**25**  
marrone 8014  
brown 8014  
marrone 8014

**26**  
verde 5293  
gothic 5293  
verde 5293

**37**  
ottone  
brass  
ottone

**39**  
nero opaco  
opaque black  
negro opaco

**60**  
verde 5123  
green 5123  
verde 5123

**68**  
grigio 9006  
gothic 9006  
gris 9006

**77**  
cromo  
chrome  
cromo

**MO**  
mogano  
mahogany  
caoba

**NO**  
noce  
walnut  
nogal

**RO**  
rovere  
oak  
roble

Art.

15 empty boxes for article number

DESCRIZIONE DESCRIPTION DESCRIPCIÓN	MATERIALE MATERIAL MATERIALE	SCATOLA BOX CAJA

Art.

15 empty boxes for article number

DESCRIZIONE DESCRIPTION DESCRIPCIÓN	MATERIALE MATERIAL MATERIALE	SCATOLA BOX CAJA

Art.

15 empty boxes for article number

DESCRIZIONE DESCRIPTION DESCRIPCIÓN	MATERIALE MATERIAL MATERIALE	SCATOLA BOX CAJA

Art.

15 empty boxes for article number

DESCRIZIONE DESCRIPTION DESCRIPCIÓN	MATERIALE MATERIAL MATERIALE	SCATOLA BOX CAJA

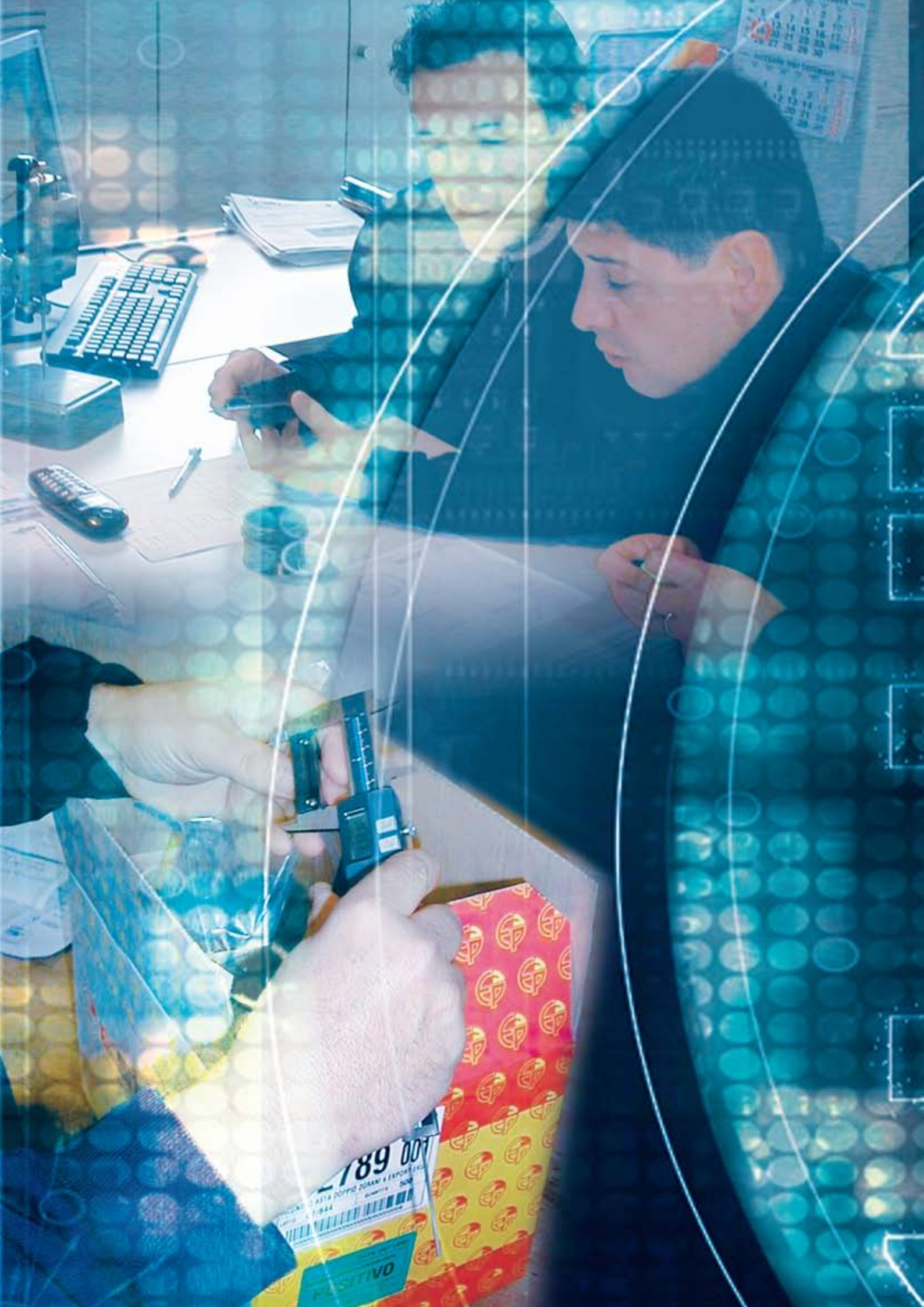

# ATTREZZATURE PER SERRAMENTI



ACCESSORIES FOR WINDOW  
AND DOOR FRAMES

ACCESORIOS  
PARA HERRAJES





00  
neutro  
neutral  
neutro

01  
nero 9005  
black 9005  
negro 9005

02  
bianco  
white  
blanco

03  
bianco 1013  
white 1013  
blanco 1013

04  
bianco 9010  
white 9010  
blanco 9010

05  
verde  
green  
verde

06  
verde 6005  
green 6005  
verde 6005

07  
marone  
brown  
marone

08  
marone 8017  
brown 8017  
marone 8017

09  
giallo 1006  
yellow 1006  
amarillo 1006

10  
grigio 7001  
grey 7001  
gris 7001

13  
rosso 3003  
red 3003  
rojo 3003

14  
argento  
silver  
plateado

15  
bronz  
bronze  
bronce

Art. 099990111.0 01



DESCRIZIONE DESCRIPTION DESCRIPCIÓN	APPLICAZIONE APPLICATION APLICACIÓN	MATERIALE MATERIAL MATERIALE	SCATOLA BOX CAJA
Rullo infila guarnizioni per zanzariera Roller for gasket insertion for mosquito net Ruleta inserción junta mosquitera		PP PA	

Art. 099990106.0 01



Rullo infila guarnizioni per precamera Roller for gasket insertion for door prechamber Ruleta inserción junta central para precámara hoja	R 40 / 50 rigida stiff - rígida	PP PA	
---	------------------------------------	----------	--

Art. 099990105.0 01



Rullo infila guarnizionir Roller for gasket insertion Ruleta inserción junta central	R 40 / 50 - GLOBAL ALL.CO 5 a sormonto overlapped superposición	PP PA	
--	--	----------	--

Art. 099990112.0 01



Rullo infila guarnizioni Roller for gasket insertion f Ruleta inserción junta central	ALL.CO 5 complanare coplanar - coplanar	PP PA	
---	--	----------	--

Art. 099991103.0 01



Rullo infila guarnizioni Roller for gasket insertion Ruleta inserción junta central	ALL.CO WOOD ALL.CO EXPORT 50 / 50 T.T. EKU 53 ALL.CO 45/45 TT ALFIL A45/A45RPT - ETA	PP PA	
---	--	----------	--

Art. 099990113.0 01



Rullo infila guarnizioni Roller for gasket insertion Ruleta inserción junta central	ALPHA 255 / 445 - BLITZ	PP PA	
---	-------------------------	----------	--

16

eletto col. nero  
electrum col. black  
anodizado col. negro

25

marrone 8014  
brown 8014  
marrone 8014

26

verde 5293  
gothic 5293  
verde 5293

37

ottone  
brass  
ottone

39

nero opaco  
opaque black  
negro opaco

60

verde 5123  
green 5123  
verde 5123

68

grigio 9006  
gothic 9006  
gris 9006

77

cromo  
chrome  
cromo

MO

mogano  
mahogany  
caoba

NO

noce  
walnut  
nogal

RO

rovere  
oak  
roble

Art. 099990116.0 01



DESCRIZIONE DESCRIPTION DESCRIPCIÓN	APPLICAZIONE APPLICATION APLICACIÓN	MATERIALE MATERIAL MATERIALE	SCATOLA BOX CAJA
Rullo infilza guarnizioni Roller for gasket insertion Ruleta inserción junta central	DOMAL STOPPER SYNTHESIS	PP PA	

Art. 099990108.0 01



Rullo infilza guarnizioni Roller for gasket insertion Ruleta inserción junta central	EKIP 40	PP PA	
--	---------	----------	--

Art. 099990107.0 01



Rullo infilza guarnizioni Roller for gasket insertion Ruleta inserción junta central	EKIP 50	PP PA	
--	---------	----------	--

Art. 099991738.0 01



Rullo infilza guarnizioni Roller for gasket insertion Ruleta inserción junta central	EKIP EVOLUTION	PP PA	
--	----------------	----------	--

Art. 099990110.0 01



Rullo infilza guarnizioni Roller for gasket insertion Ruleta inserción junta central	nuovo - new - nuevo NC 40	PP PA	
--	------------------------------	----------	--

Art. 099990114.0 01



Rullo infilza guarnizioni Roller for gasket insertion Ruleta inserción junta central	NC 45 SUPERTHERMIC NC 45 INTERNATIONAL	PP PA	
--	---	----------	--

00  
neutro  
neutral  
neutro

01  
nero 9005  
black 9005  
negro 9005

02  
bianco  
white  
bianco

03  
bianco 1013  
white 1013  
blanco 1013

04  
bianco 9010  
white 9010  
blanco 9010

05  
verde  
green  
verde

06  
verde 6005  
green 6005  
verde 6005

07  
marrone  
brown  
marrone

08  
marrone 8017  
brown 8017  
marrone 8017

09  
giallo 1006  
yellow 1006  
amarillo 1006

10  
grigio 7001  
grey 7001  
gris 7001

13  
rosso 3003  
red 3003  
rojo 3003

14  
argento  
silver  
plateado

15  
bronzo  
bronze  
bronce

Art. 099990109.0 01



DESCRIZIONE DESCRIPTION DESCRIPCIÓN	APPLICAZIONE APPLICATION APLICACIÓN	MATERIALE MATERIAL MATERIALE	SCATOLA BOX CAJA
Rullo infila guarnizioni Roller for gasket insertion Ruleta inserción junta central	DECORA SISTEMA 1 - SISTEMA 2 WOOD (PROFILATI s.p.a. T.E.S.)	PP PA	

Art. 099990681.0 01



Rullo infila guarnizioni Roller for gasket insertion Ruleta inserción junta central	NEW TEC	PP PA	
---	---------	----------	--

Art. 099992921.0 01



Rullo infila guarnizioni Roller for gasket insertion Ruleta inserción junta central	WIND STOP 45 TT / 55 TT (PONZIO)	PP PA	
---	-------------------------------------	----------	--

Art. 099990028.0 01



Rullo infila guarnizioni per giunto aperto universale Roller for gasket insertion for universal open joint Ruleta inserción junta central para unión abierta universal		PP PA	
--	--	----------	--

Art. 099991104.0 01









Rullo infila guarnizioni Roller for gasket insertion Ruleta inserción junta central	serie - series - serie ALULEN THERMIC	PP PA	
--	--	----------	--

Art. 099992127.0 01

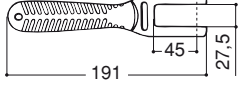

Rullo infila guarnizioni Roller for gasket insertion Ruleta inserción junta central	nuova serie - new series nueva serie ALULEN	PP PA	
--	--	----------	--

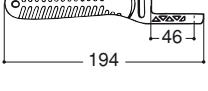
Art. 099991990.0	01											DESCRIZIONE DESCRIPTION DESCRIPCIÓN	APPLICAZIONE APPLICATION APLICACIÓN	MATERIALE MATERIAL MATERIALE	SCATOLA BOX CAJA
												Rullo infilza guarnizioni Roller for gasket insertion Ruleta inserción junta central	Z 106-111-113	PA	
												Rullo infilza pinna Roller for fin Ruleta inserción junta central	GOLD 490	PP PA	
												Rullo infilza guarnizioni Roller for gasket insertion Ruleta inserción junta central	ABITHAL GREEN ABITHAL KEEPER 53/60 ABITHAL KEEPER 60/68	PA	
												Rullo infilza guarnizioni Roller for gasket insertion Ruleta inserción junta central	ALU-K serie - series - serie 45 CO	PP PA	
												Manico per rullo infilza guarnizioni a due bracci Handle for roller for gas insertion with two arms Empuñadura de dos brazos para ruleta inserción juntas		PP	
												Manico per rullo infilza guarnizioni a un braccio Handle for roller for gas insertion with one arm Empuñadura de un brazo para ruleta inserción junta		PA CAR	

00  
neutro  
neutral  
neutro

01  
nero 9005  
black 9005  
negro 9005

02  
bianco  
white  
blanco

03  
bianco 1013  
white 1013  
blanco 1013

04  
bianco 9010  
white 9010  
blanco 9010

05  
verde  
green  
verde

06  
verde 6005  
green 6005  
verde 6005

07  
marone  
brown  
marone

08  
marone 8017  
brown 8017  
marone 8017

09  
giallo 1006  
yellow 1006  
amarillo 1006

10  
grigio 7001  
grey 7001  
gris 7001

13  
rosso 3003  
red 3003  
rojo 3003

14  
argento  
silver  
plateado

15  
bronzo  
bronze  
bronce

Art. 099990056.0 01

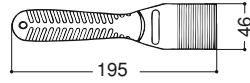

DESCRIZIONE DESCRIPTION DESCRIPCIÓN	APPLICAZIONE APPLICATION APLICACIÓN	MATERIALE MATERIAL MATERIALE	SCATOLA BOX CAJA
Spatola piccola per sollevamento vetri Small spatula for glass lifting Pala pequeña para montaje cristales		PA CAR	

Art. 099990057.0 01

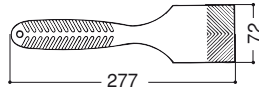

Spatola grande per sollevamento vetri Big spatula for glass lifting Pala grande para montaje cristales		PA CAR	
--	--	-----------	--

Art. 099990060.0 01



Tagliere per imballaggi e infila guarnizioni ferma vetro Cutter for packing and glass-stop gasket insertion Corta embalajes y inserción junta acristalar		PA CAR	
--	--	-----------	--

Art. 099990288.0 01



Leva per montaggio e smontaggio clips Lever to assemble and disassemble clips Palanca para montaje y desmontaje clips	serie - series - serie ALPHA 445 - GLOBO	PA ACC	
---	---	-----------	--

Art. 099991981.0 01





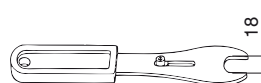

Leva per montaggio e smontaggio clips Lever to assemble and disassemble clips Palanca para montaje y desmontaje clips	serie - series - serie GOLD INDINVEST	PA ACC	
---	--	-----------	--

Art. 099991128.0 01

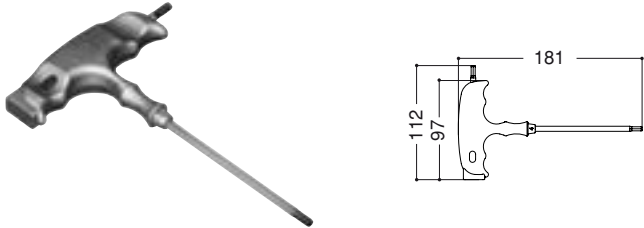
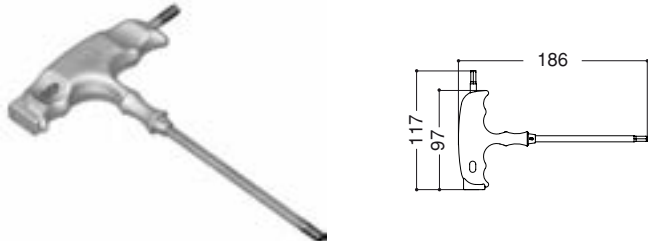

Chiave per rotazione blocchetto di assemblaggio (cod. 1638) profili legno / alluminio Rotation key of assembly block (code 1638) wood / aluminium profiles Llave para rotación bloque de ensamblaje (cód. 1638) perfiles madera / aluminio		PA ACC	
--	--	-----------	--

Art. 099993034.0 01	DESCRIZIONE DESCRIPTION DESCRIPCIÓN	APPLICAZIONE APPLICATION APLICACIÓN	MATERIALE MATERIAL MATERIALE	SCATOLA BOX CAJA
	<p>Chiave piegata per rotazione blocchetto di assemblaggio (cod. 1638) profili legno / alluminio</p> <p>Bent spanner for rotation of assembly block (cod. 1638) wood / aluminium profiles</p> <p>Llave piegada para rotación bloque de ensamblaje (cód. 1638) perfiles madera / aluminio</p>		PA ACC	
	<p>Chiave per vite con cava esagonale mm 2</p> <p>Allen wrench mm 2</p> <p>Llave para tornillo con cabeza hueca hexagonal 2 mm</p>		PP ACC	
	<p>Chiave per vite con cava esagonale mm 2,5</p> <p>Allen wrench mm 2.5</p> <p>Llave para tornillo con cabeza hueca hexagonal 2,5 mm</p>		PP ACC	
	<p>Chiave per vite con cava esagonale mm 3</p> <p>Allen wrench mm 3</p> <p>Llave para tornillo con cabeza hueca hexagonal 3 mm</p>		PP ACC	
	<p>Chiave per vite con cava esagonale mm 4</p> <p>Allen wrench mm 4</p> <p>Llave para tornillo con cabeza hueca hexagonal 4 mm</p>		PP ACC	
	<p>Chiave per vite con cava esagonale mm 5</p> <p>Allen wrench mm 5</p> <p>Llave para tornillo con cabeza hueca hexagonal 5 mm</p>		PP ACC	



16

eletto col. nero  
electrum col. black  
anodizado col. negro

25

marrone 8014  
brown 8014  
marrone 8014

26

verde 5293  
gothic 5293  
verde 5293

37

ottone  
brass  
ottone

39

nero opaco  
opaque black  
negro opaco

60

verde 5123  
green 5123  
verde 5123

68

grigio 9006  
gothic 9006  
gris 9006

77

cromo  
chrome  
cromo

MO

mogano  
mahogany  
caoba

NO

noce  
walnut  
nogal

RO

rovere  
oak  
roble

		DESCRIZIONE DESCRIPTION DESCRIPCIÓN	APPLICAZIONE APPLICATION APLICACIÓN	MATERIALE MATERIAL MATERIALE	SCATOLA BOX CAJA
<b>Art.</b>					
<b>Art.</b>					
<b>Art.</b>					
<b>Art.</b>					
<b>Art.</b>					
<b>Art.</b>					





# ACCESSORI PER ASSEMBLAGGIO



ACCESSORIES  
FOR ASSEMBLY

ACCESORIOS  
PARA ENSAMBLAR



Art. 099990027.0 01 03 04 06 08 10 26

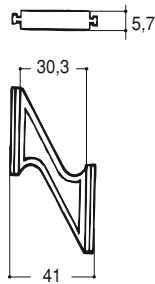

DESCRIZIONE  
DESCRIPTION  
DESCRIPCIÓN

Sella reversibile (1° tipo)  
persiana fissa alla  
genovese per ovalina  
mm 50x10

Reversible saddle (1st type)  
for genovese fixed shutter  
for 50x10 mm ovaline for

Soporte reversible (1° tipo)  
persiana fija tipo genovés  
para lama ovalina  
50x10 mm



APPLICAZIONE  
APPLICATION  
APLICACIÓN

FB 12 - METRA - ALL.CO -  
ALCAN - ABITHAL etc.

MATERIALE  
MATERIAL  
MATERIALE

PP

SCATOLA  
BOX  
CAJA

5.000  
Pz

Art. 099990061.0 01 03 04 06 08 10 26

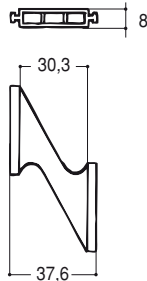

Sella reversibile persiana  
fissa alla genovese per  
ovalina mm 50x10

Reversible saddle for  
genovese fixed shutter for  
50x10 mm ovaline

Soporte reversible persiana  
fija tipo genovés para  
lama ovalina 50x10 mm

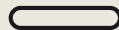

FB 12 - METRA - ALL.CO -  
ALCAN - ABITHAL

PP

5.000  
Pz

Art. 099992870.0 01 03 04 06 08 10 26

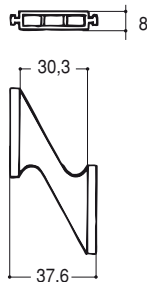
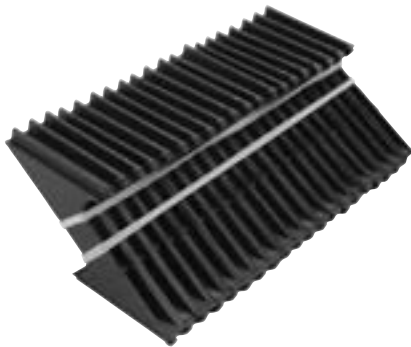

Kit da 20 selle reversibili  
persiana fissa alla  
genovese per ovalina  
mm 50x10

20 reversibles saddles kit  
for genovese fixed shutter  
for 50x10 mm ovaline

Kit de 20 soporte  
reversible persiana fija tipo  
genovés para lama ovalina  
50x10 mm

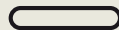

FB 12 - METRA - ALL.CO -  
ALCAN - ABITHAL

PP

100  
Kit

Art. 099992784.0 01 03 04 06 08 10 26

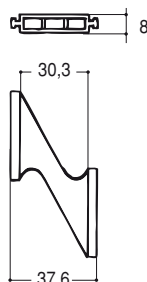

Blister da 100 selle  
reversibili persiana fissa  
alla genovese per ovalina  
mm 50x10

100 reversibles saddles  
blister for genovese fixed  
shutter for 50x10 mm  
ovaline

Blister de 100 soporte  
reversible persiana fija tipo  
genovés para lama ovalina  
50x10 mm

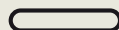

FB 12 - METRA - ALL.CO -  
ALCAN - ABITHAL

PP

1  
Blister

16  
 elettro col. nero  
 electrum col. black  
 anodizado col. negro

25  
 marrone 8014  
 brown 8014  
 marrone 8014

26  
 verde 5293  
 gothic 5293  
 verde 5293

37  
 ottone  
 brass  
 ottone

39  
 nero opaco  
 opaque black  
 negro opaco

60  
 verde 5123  
 green 5123  
 verde 5123





68  
 grigio 9006  
 gothic 9006  
 gris 9006

77  
 cromo  
 chrome  
 cromo

MO  
 mogano  
 mahogany  
 caoba

NO  
 noce  
 walnut  
 nogal

RO  
 rovere  
 oak  
 roble

DESCRIZIONE DESCRIPTION DESCRIPCION	APPLICAZIONE APPLICATION APLICACION	MATERIALE MATERIAL MATERIALE	SCATOLA BOX CAJA
<p><b>Art. 099990072.0</b> 01 03 04 06 08 10 26</p>  <p>Sella reversibile persiana fissa per ovalina mm 50x10                      Reversible saddle for fixed shutter for 50x10 mm ovaline                      Soporte reversible persiana fija para lama ovalina 50x10 mm</p>	<p>DOMAL GELOSIA                      DOMAL 40                      DOMAL STOPPER PG                      ALL.CO 5/1556</p>	<p>PP</p>	<p>4.000                      Pz</p>
<p><b>Art. 099991116.0</b> 01 03 04 06 08 10 26</p>  <p>Sella reversibile persiana fissa per ovalina mm 50x10                      Reversible saddle for fixed shutter for 50x10 mm ovaline                      Soporte reversible persiana fija para lama ovalina 50x10 mm</p>	<p>DOMAL 21662                      DOMAL 40 / 19741                      GR 9 - R40 - ALPHA 445 -                      NEW TEC PQ 4875</p>	<p>PP</p>	<p>2.500                      Pz</p>
<p><b>Art. 099990069.0</b> 01 03 04 06 08 10 26</p>  <p>Sella reversibile persiana fissa ovalina mm 50x10                      Reversible saddle for fixed shutter for 50x10 mm ovaline                      Soporte reversible persiana fija para lama ovalina 50x10 mm</p>	<p>EKIP 40 - METRA - GR 9 - NC                      ALL.CO SPRINT P 4                      EURO 40 - SYNTHESIS -                      SISTEMA 1 - ALU ■ K 494                      ALL.CO 1494/1549</p>	<p>PP</p>	<p>2.500                      Pz</p>
<p><b>Art. 099990059.0</b> 01 03 04 06 08 10 26</p>  <p>Sella reversibile persiana fissa per ovalina mm 50x10                      Reversible saddle for fixed shutter for 50x10 mm ovaline                      Soporte reversible persiana fija para lama ovalina 50x10 mm</p>	<p>ALL.CO 1494 / 1549</p>	<p>PP</p>	<p>2.500                      Pz</p>

00 neutro neutral neutro	01 nero 9005 black 9005 negro 9005	02 bianco white blanco	03 bianco 1013 white 1013 blanco 1013	04 bianco 9010 white 9010 blanco 9010	05 verde green verde	06 verde 6005 green 6005 verde 6005	07 marrone brown marrone	08 marrone 8017 brown 8017 marrone 8017	09 giallo 1006 yellow 1006 amarillo 1006	10 grigio 7001 grey 7001 gris 7001	13 rosso 3003 red 3003 rojo 3003	14 argento silver plateado	15 bronzo bronze bronce
-----------------------------------	---	---------------------------------	--	--	-------------------------------	--	-----------------------------------	--	---	---	---	-------------------------------------	----------------------------------

Art. 099990058.0 01 03 04 06 08 10 26

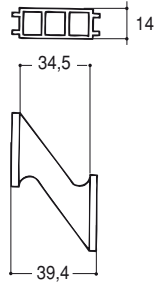

DESCRIZIONE  
DESCRIPTION  
DESCRIPCIÓN

Sella reversibile persiana  
fissa per ovalina mm 50x10  
Reversible saddle for fixed  
shutter for 50x10 mm  
ovaline  
Soporte reversible persiana  
fija para lama ovalina  
50x10 mm

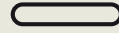

APPLICAZIONE  
APPLICATION  
APLICACIÓN

R 40 - ALPHA 455

MATERIALE  
MATERIAL  
MATERIALE

PP

SCATOLA  
BOX  
CAJA

2.500  
Pz

Art. 099991900.0 01 03 04 06 08 10 26

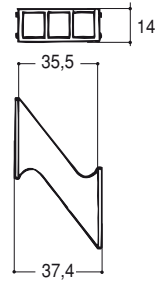

Sella reversibile persiana  
fissa per ovalina  
mm 50x10  
Reversible saddle for fixed  
shutter for 50x10 mm  
ovaliner  
Soporte reversible persiana  
fija para lama ovalina  
50x10 mm



ALL.CO 5 - VZ 3608 ALL.  
CO P4 - VZ 0747 /  
VZ 0739 - GOLD 400 /  
40109

PP

2.500  
Pz

Art. 099993047.0 01 03 04 06 08 10 26

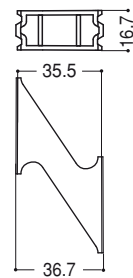

Sella reversibile persiana  
fissa per profili camera  
mm 36x17 ovalina  
mm 50x10  
Reversible saddle  
for fixed shutter  
for profiles 36x17 mm  
50x10 mm ovaliner

Soporte reversible persiana  
fija para perfiles cámara  
14x35 mm ovalina  
50x10 mm

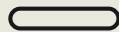

PP

500  
Pz

Art. 099993048.3 01 03 04 06 08 10 26

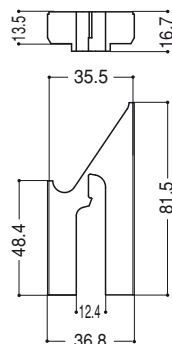

Compensatore dx - sx  
persiana fissa per profili  
camera mm 36x17  
ovalina mm 50x10

Right - left compensator  
for fixed shutter for  
profiles 36x17 mm  
50x10 mm ovaliner

Compensadore dch-izq  
persiana fija para perfiles  
cámara 36x17 mm  
ovalina 50x10 mm

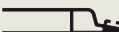

PP

50  
Pz

16  
 elettro col. nero  
 electrum col. black  
 anodizado col. negro

25  
 marrone 8014  
 brown 8014  
 marrone 8014

26  
 verde 5293  
 gothic 5293  
 verde 5293

37  
 ottone  
 brass  
 ottone

39  
 nero opaco  
 opaque black  
 negro opaco

60  
 verde 5123  
 green 5123  
 verde 5123

68  
 grigio 9006  
 gothic 9006  
 gris 9006

77  
 cromo  
 chrome  
 cromo

MO  
 mogano  
 mahogany  
 caoba

NO  
 noce  
 walnut  
 nogal

RO  
 rovere  
 oak  
 roble

Art. 099992860.0 01 03 04 06 08 10 26

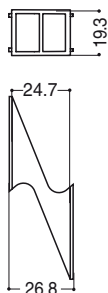

DESCRIZIONE  
 DESCRIPTION  
 DESCRIPCIÓN

APPLICAZIONE  
 APPLICATION  
 APLICACIÓN

MATERIALE  
 MATERIAL  
 MATERIALE

SCATOLA  
 BOX  
 CAJA

Sella reversibile persiana fissa per profili vetro infilare camera mm 25x19,3 per ovalina mm 50x10

Reversible saddle for fixed shutter for thread glass profiles 25x19,3 mm camera for 50x10 mm ovaline

Soporte reversibile persiana fija perfiles cristal inserción cámara 25x19,3 mm para lama ovalina 50x10 mm

PP

2.500  
 Pz



Art. 099992773.0 01 03 04 06 08 10 26

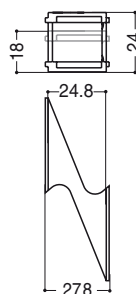

Sella reversibile persiana fissa per profilo vetro ad infilare camera mm 25x24 max - 18 minimo per ovalina mm 50x10

Reversible saddle for fixed shutter for thread glass profile 25x24 max - 18 minimum mm camera for 50x10 mm ovaline

Soporte reversibile persiana fija perfil cristal inserción cámara máx. 25x24mm - mín. 18 mm para lama ovalina 50x10 mm

PP

250  
 Pz



Art. 099992774.0 01 03 04 06 08 10 26

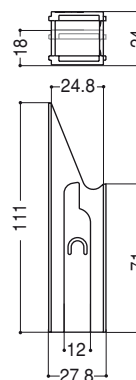

Mezza sella reversibile persiana fissa per profilo vetro ad infilare camera mm 25x24 max - 18 minimo per ovalina mm 50x10

Half reversible saddle for fixed shutter for thread glass profile 25x24 max - 18 minimum mm camera for 50x10 mm ovaline

Terminal soporte reversibile persiana fija perfil cristal inserción cámara máx. 25x24mm - mín. 18 mm para lama ovalina 50x10 mm

PP

150  
 Pz



Art. 099990698.0 01 03 04 06 08 10 26

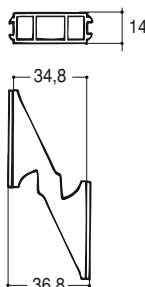

Sella reversibile persiana fissa per lamella NACO SP 54

Reversible saddle for fixed shutter per lamella NACO SP 54

Soporte reversibile persiana fija per lamella NACO SP 54

R 40  
 R 40 storico - storic - histórico  
 ALPHA 445

PP

2.000  
 Pz



00 neutro neutral neutro	01 nero 9005 black 9005 negro 9005	02 bianco white blanco	03 bianco 1013 white 1013 blanco 1013	04 bianco 9010 white 9010 blanco 9010	05 verde green verde	06 verde 6005 green 6005 verde 6005	07 marone brown marone	08 marone 8017 brown 8017 marone 8017	09 giallo 1006 yellow 1006 amarillo 1006	10 grigio 7001 grey 7001 gris 7001	13 rosso 3003 red 3003 rojo 3003	14 argento silver plateado	15 bronzo bronze bronce
-----------------------------------	---	---------------------------------	--	--	-------------------------------	--	---------------------------------	--	---	---	---	-------------------------------------	----------------------------------

Art. 09992090.0 01 03 04 06 08 10 26

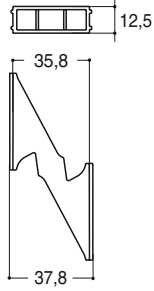

DESCRIZIONE DESCRIPTION DESCRIPCIÓN	APPLICAZIONE APPLICATION APLICACIÓN	MATERIALE MATERIAL MATERIALE	SCATOLA BOX CAJA
<p>Sella reversibile persiana fissa per profili camera mm 12,5x36 lamella NACO SP 54</p> <p>Reversible saddle for fixed shutter for profiles 12.5x36 mm camera lamella NACO SP 54</p> <p>Soporte reversible persiana fija para perfiles cámara 12.5x36 mm lamella NACO SP 54</p> 		PP	1.000 Pz

Art. 09991808.0 01 03 04 06 08 10 26

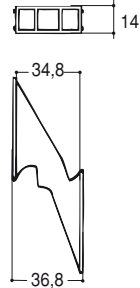

<p>Sella reversibile persiana fissa per profili camera mm 14x35 lamella UNIVERSAL 55</p> <p>Reversible saddle for fixed shutter for profiles 14x35 mm camera lamella UNIVERSAL 55</p> <p>Soporte reversible persiana fija para perfiles cámara 14x35 mm lamella UNIVERSAL 55</p> 		PP	1.000 Pz
---	--	----	----------

Art. 09992080.0 01 03 04 06 08 10 26

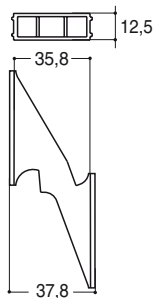



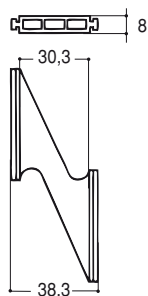

<p>Sella reversibile persiana fissa per profili camera mm 12,5x36 lamella UNIVERSAL 55</p> <p>Reversible saddle for fixed shutter for profiles 12.5x36 mm camera lamella UNIVERSAL 55</p> <p>Soporte reversible persiana fija para perfiles cámara 12.5x36 mm lamella UNIVERSAL 55</p> 		PP	1.000 Pz
---	--	----	----------

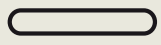
Art. 09990029.0 01 03 04 06 08 10 26



<p>Sella reversibile persiana fissa alla genovese per ovalina mm 60x10</p> <p>Reversible saddle for genovese fixed shutter for 60x10 mm ovaline</p> <p>Soporte reversible persiana fija tipo genovés para lama ovalina 60x10 mm</p> 	FB 12 - METRA - ALLCO - ALLCAN - ABITHAL	PP	4.000 Pz
--	--	----	----------

DESCRIZIONE DESCRIPTION DESCRIPCIÓN	APPLICAZIONE APPLICATION APLICACIÓN	MATERIALE MATERIAL MATERIALE	SCATOLA BOX CAJA
<p><b>Art. 099991826.0</b> 01 03 04 06 08 10 26</p>  <p>Sella reversibile persiana fissa per ovalina mm 65x10                  Reversible saddle for fixed shutter for 65x10 mm ovaline                  Soporte reversible persiana fija para lama ovalina 65x10 mm</p>	<p>DOMAL GELOSIA DOMAL 40 DOMAL STOPPER PG ALL.CO 5 / 1556</p>	<p>PP</p>	<p>3.000 Pz</p>
<p><b>Art. 099990104.0</b> 01 03 04 06 08 10 26</p>  <p>Sella reversibile persiana fissa alla genovese per ovalina mm 65x10                  Reversible saddle for genovese fixed shutter for 65x10 mm ovaline                  Soporte reversible persiana fija tipo genovés para lama ovalina 65x10 mm</p>	<p>FB 12 - METRA - ALL.CO - ALCAN - ABITHAL</p>	<p>PP</p>	<p>2.500 Pz</p>
<p><b>Art. 099991533.0</b> 01 03 04 06 08 10 26</p>  <p>Sella reversibile persiana fissa per ovalina mm 65x10                  Reversible saddle for fixed shutter for 65x10 mm ovaline                  Soporte reversible persiana fija para lama ovalina 65x10 mm</p>	<p>EKIP 40 - METRA - GR 9 - NC ALL.CO SPRINT P 4 EURO 40 - SYNTHESIS - SISTEMA 1 - ALU ■ K 494</p>	<p>PP</p>	<p>1.000 Pz</p>
<p><b>Art. 099991824.0</b> 01 03 04 06 08 10 26</p>  <p>Sella reversibile persiana fissa per ovalina mm 65x10                  Reversible saddle for fixed shutter for 65x10 mm ovaline                  Soporte reversible persiana fija para lama ovalina 65x10 mm</p>	<p>R40 - ALPHA 445 DOMAL 21662 DOMAL 40/19741 - GR 9 NEW TEC PQ 4875</p>	<p>PP</p>	<p>1.000 Pz</p>



00	01	02	03	04	05	06	07	08	09	10	13	14	15
neutro neutral neutro	nero 9005 black 9005 negro 9005	bianco white blanco	bianco 1013 white 1013 blanco 1013	bianco 9010 white 9010 blanco 9010	verde green verde	verde 6005 green 6005 verde 6005	marone brown marone	marone 8017 brown 8017 marone 8017	giallo 1006 yellow 1006 amarillo 1006	grigio 7001 grey 7001 gris 7001	rosso 3003 red 3003 rojo 3003	argento silver plateado	bronzo bronze bronce

Art. 09992051.0 01 03 04 06 08 10 26

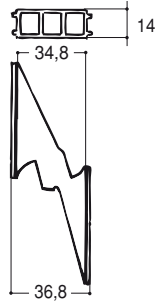

DESCRIZIONE DESCRIPTION DESCRIPCIÓN	APPLICAZIONE APPLICATION APLICACIÓN	MATERIALE MATERIAL MATERIALE	SCATOLA BOX CAJA
<p>Sella reversibile persiana fissa per profili camera mm 14x35 lamella PERLA 70</p> <p>Reversible saddle for fixed shutter for profiles 14x35 mm camera lamella PERLA 70</p> <p>Soporte reversible persiana fija para perfiles cámara 14x35 mm lamella PERLA 70</p> 		PP	1.000 Pz

Art. 099990196.0 01 03 04 06 08 10 26

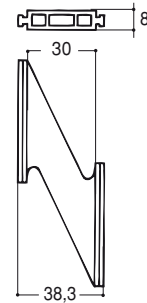

<p>Sella reversibile persiana fissa alla genovese per lamella centro storico mm 65x10</p> <p>Reversible saddle for genovese fixed shutter lamella centro storico 65x10 mm</p> <p>Soporte reversible persiana fija tipo genovés para lama tipo centro histórico 65x10 mm</p> 		PP	2.500 Pz
--	--	----	-------------

Art. 09992872.0 01 03 04 06 08 10 26

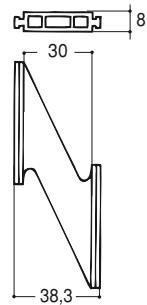
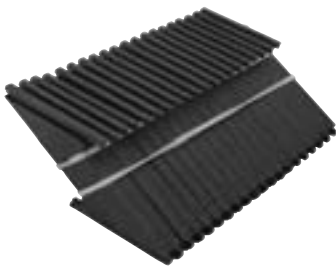

<p>Kit da 20 selle reversibili persiana fissa alla genovese per lamella centro storico mm 65x10</p> <p>20 reversibles saddles kit for genovese fixed shutter lamella centro storico 65x10 mm</p> <p>Kit de 20 soporte reversible persiana fija tipo genovés para lama tipo centro histórico 65x10 mm</p> 		PP	50 Kit
---	--	----	-----------

Art. 010322890.0 01 03 04 06 08 10 26

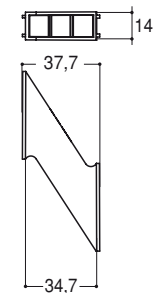

<p>Sella reversibile persiana fissa lamella centro storico Firenze mm 65x10</p> <p>Reversible saddle for fixed shutter lamella centro storico Firenze 65x10 mm</p> <p>Soporte reversible persiana fija lamella centro histórico Firenze 65x10 mm</p> 	DEMAL camera mm 14x35	PE	1.000 Pz
---	-----------------------	----	-------------

16  
 elettro col. nero  
 electrum col. black  
 anodizado col. negro

25  
 marrone 8014  
 brown 8014  
 marrone 8014

26  
 verde 5293  
 gothic 5293  
 verde 5293

37  
 ottone  
 brass  
 ottone

39  
 nero opaco  
 opaque black  
 negro opaco

60  
 verde 5123  
 green 5123  
 verde 5123

68  
 grigio 9006  
 gothic 9006  
 gris 9006

77  
 cromo  
 chrome  
 cromo

MO  
 mogano  
 mahogany  
 caoba

NO  
 noce  
 walnut  
 nogal

RO  
 rovere  
 oak  
 roble

Art. 006372890.0 01 03 04 06 08 10 26

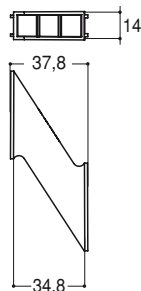

DESCRIZIONE DESCRIPTION DESCRIPCIÓN	APPLICAZIONE APPLICATION APLICACIÓN	MATERIALE MATERIAL MATERIALE	SCATOLA BOX CAJA
<p>Sella reversibile persiana fissa lamella centro storico Firenze mm 65x9</p> <p>Reversible saddle for fixed shutter lamella centro storico Firenze 65x9 mm</p> <p>Soporte reversible persiana fija lamella centro histórico Firenze 65x9 mm</p> 	ALL.CO camera mm 14x35	PP	1.000 Pz

Art. 099991980.0 01 03 04 06 08 10 26

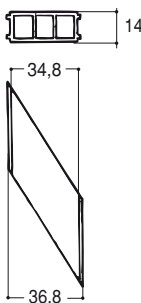

<p>Sella reversibile persiana fissa per profili camera mm 14x35 lamella centro storico Firenze</p> <p>Reversible saddle for fixed shutter for profiles 14x35 mm camera lamella centro storico Firenze</p> <p>Soporte reversible persiana fija para perfiles cámara 14x35 mm lamella centro histórico Firenze</p> 		PP	2.000 Pz
---	--	----	----------

Art. 099991535.0 01

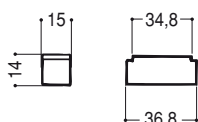

<p>Spessore mm 15 per mezza sella Artt. 1116 - 0058</p> <p>15 mm thickness for half saddle art. 1116 - 0058</p> <p>Espesor 15 mm para medio soporte Art. 1116 - 0058</p>		PP	4.000 Pz
--	--	----	----------

Art. 099992936.3 01

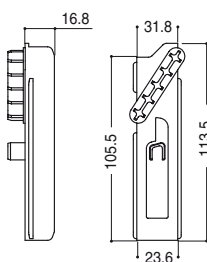

<p>Compensatore dx-sx                      Right - Left compensator                      Compensador Dch-lzd</p>	persiana - shutter persiana KL	PA	50 coppie pairs parejas
--	-----------------------------------	----	-------------------------------

00

neutro  
neutral  
neutro

01

nero 9005  
black 9005  
negro 9005

02

bianco  
white  
blanco

03

bianco 1013  
white 1013  
blanco 1013

04

bianco 9010  
white 9010  
blanco 9010

05

verde  
green  
verde

06

verde 6005  
green 6005  
verde 6005

07

marone  
brown  
marone

08

marone 8017  
brown 8017  
marone 8017

09

giallo 1006  
yellow 1006  
amarillo 1006

10

grigio 7001  
grey 7001  
gris 7001

13

rosso 3003  
red 3003  
rojo 3003

14

argento  
silver  
plateado

15

bronzo  
bronze  
bronce

Art. 099992935.3

01

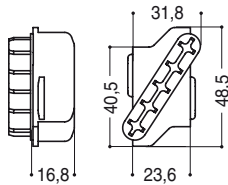
DESCRIZIONE  
DESCRIPTION  
DESCRIPCIÓN

Distanziale aperto dx-sx  
per ovalina mm 50x10  
Right-Left open spacer for  
50x10 mm ovaline  
Distanciadador abierto  
Dch-lzd para lama ovalina  
50x10 mm

APPLICAZIONE  
APPLICATION  
APLICACIÓN

persiana - shutter  
persiana KL

MATERIALE  
MATERIAL  
MATERIAL

PA

SCATOLA  
BOX  
CAJA

1.000  
coppie  
pairs  
parejas

Art. 099990022.3

01

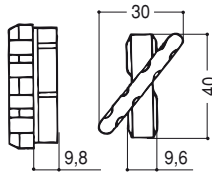

Distanziale aperto dx-sx  
mm 40 per ovalina  
mm 50x10  
Right-Left open spacer  
40 mm for 50x10 mm  
ovaline  
Distanciadador abierto  
Dch-lzd 40 mm para lama  
ovalina 50x10 mm

PP

2.000  
coppie  
pairs  
parejas

Art. 099990019.3

01

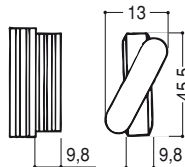

Distanziale chiuso dx-sx  
mm 45,5 per ovalina  
mm 50x10  
Right-Left close spacer  
45,5 mm for 50x10 mm  
ovaline  
Distanciadador cerrado  
Dch-lzd 45,5 mm para  
lama ovalina 50x10 mm

PA

400  
coppie  
pairs  
parejas

Art. 099990042.3

01

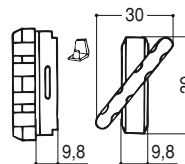

Distanziale aperto dx-sx  
mm 39 con spessore per  
ovalina mm 50x10  
Right-Left open spacer  
39 mm with thickness for  
50x10 mm ovaline  
Distanciadador abierto  
Dch-lzd 39 mm con  
espesor para lama  
ovalina 50x10 mm

PP

2.000  
coppie  
pairs  
parejas

Art. 099990025.3

01

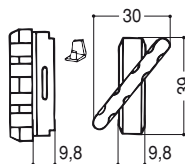

Distanziale aperto dx-sx  
mm 39 con spessore per  
ovalina mm 50x10  
Right-Left open spacer  
39 mm with thickness for  
50x10 mm ovaline  
Distanciadador abierto  
Dch-lzd 39 mm con  
espesor para lama  
ovalina 50x10 mm

PA

2.000  
coppie  
pairs  
parejas

Art. 099990078.3

01

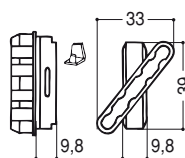

Distanziale aperto dx-sx  
mm 39 con bordino  
e spessore per ovalina  
mm 50x10  
Right-Left open spacer  
39 mm with flange and  
thickness for 50x10 mm  
ovaline  
Distanciadador abierto Dch-lzd  
39 mm con borde y espesor  
para lama ovalina 50x10 mm

PP

2.000  
coppie  
pairs  
parejas

16  
 elettro col. nero  
 electrum col. black  
 anodizado col. negro

25  
 marrone 8014  
 brown 8014  
 marrone 8014

26  
 verde 5293  
 gothic 5293  
 verde 5293

37  
 ottone  
 brass  
 ottone

39  
 nero opaco  
 opaque black  
 negro opaco

60  
 verde 5123  
 green 5123  
 verde 5123









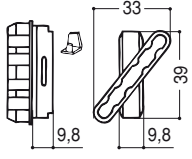

68  
 grigio 9006  
 gothic 9006  
 gris 9006

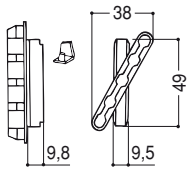
77  
 cromo  
 chrome  
 cromo

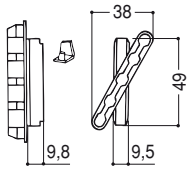
MO  
 mogano  
 mahogany  
 caoba

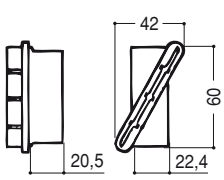
NO  
 noce  
 walnut  
 nogal

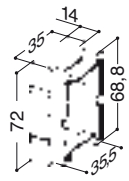
RO  
 rovere  
 oak  
 roble

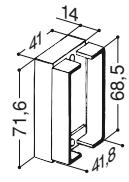
DESCRIZIONE DESCRIPTION DESCRIPCION	APPLICAZIONE APPLICATION APLICACION	MATERIALE MATERIAL MATERIAL	SCATOLA BOX CAJA
<p><b>Art. 09999010.3</b> 01</p>   <p>Distanziale aperto dx-sx mm 39 con bordino e spessore per ovalina mm 50x10 Right-Left open spacer 39 mm with flange and thickness for 50x10 mm ovaline Distanciadador abierto Dch-lzd 39 mm con borde y espesor para lama ovalina 50x10 mm</p>		PA	2.000 coppie pairs parejas
<p><b>Art. 099990102.3</b> 01</p>   <p>Distanziale aperto dx-sx mm 49 con bordino e spessore per ovalina mm 65x10 Right-Left open spacer 49 mm with flange and thickness for 65x10 mm ovaline Distanciadador abierto Dch-lzd 49 mm con borde y espesor para lama ovalina 65x10 mm</p>		PP	1.000 coppie pairs parejas
<p><b>Art. 099990103.3</b> 01</p>   <p>Distanziale aperto dx-sx mm 49 con bordino e spessore per ovalina mm 65x10 Right-Left open spacer 49 mm with flange and thickness for 65x10 mm ovaline Distanciadador abierto Dch-lzd 49 mm con borde y espesor para lama ovalina 65x10 mm</p>		PA	1.000 coppie pairs parejas
<p><b>Art. 099991818.3</b> 01</p>   <p>Distanziale aperto dx-sx mm 60 con bordino e spessore per lamella Kosmica mm 72,5 Right-Left open spacer 60 mm with flange and thickness for lamella Kosmica mm 72,5 Distanciadador abierto Dch-lzd 60 mm con borde y espesor lamella Kosmica mm 72,5</p>	camera METALTECNICA	PP	500 coppie pairs parejas
<p><b>Art. 099992124.0</b> 01</p>   <p>Giunto per persiana Joint for shutter Unión para persiana</p>	DOMAL 26212 / 19735 / 26205 - ALUMEC SISTEMA 1 4092 / 4037 / 4093	PA	500 Pz
<p><b>Art. 099991805.0</b> 01</p>   <p>Giunto Joint Unión</p>	DOMAL INDOOR 27503 / 27504	PA	500 Pz

00

neutro  
neutral  
neutro

01

nero 9005  
black 9005  
negro 9005

02

bianco  
white  
blanco

03

bianco 1013  
white 1013  
blanco 1013

04

bianco 9010  
white 9010  
blanco 9010

05

verde  
green  
verde

06

verde 6005  
green 6005  
verde 6005

07

marrone  
brown  
marrone

08

marrone 8017  
brown 8017  
marrone 8017

09

giallo 1006  
yellow 1006  
amarillo 1006

10

grigio 7001  
grey 7001  
gris 7001

13

rosso 3003  
red 3003  
rojo 3003

14

argento  
silver  
plateado

15

bronzo  
bronze  
bronce

Art. 099990122.0

01

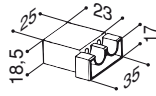

DESCRIZIONE DESCRIPTION DESCRIPCIÓN	APPLICAZIONE APPLICATION APLICACIÓN	MATERIALE MATERIAL MATERIAL	SCATOLA BOX CAJA
Giunto Joint Unión	DOMAL STOPPER PG	PA	200 Pz

Art. 099991426.0

01

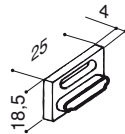

Spessore per giunti artt. 0122 - 1122 Thickness for joints art. 0122 - 1122 Espesor para uniones art. 0122 - 1122		PA	100 Pz
--	--	----	-----------

Art. 099991122.0

01

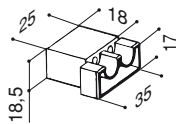

Giunto Joint: Unión	DOMAL 40 19658 / 26174	PA	1.000 Pz
---------------------------	---------------------------	----	-------------

Art. 099990235.0

01

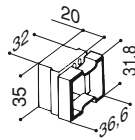

Giunto per profili persiana fascia bassa Joint for low-band shutter profiles Unión para perfiles persiana banda baja	DOMAL GELOSIA DOMAL GELOSIA 40	PA	1.000 Pz
---	-----------------------------------	----	-------------

Art. 099990680.0

01

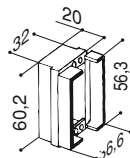

Giunto per profili persiana fascia alta Joint for high-band shutter profiles Unión para perfiles persiana banda alta	DOMAL GELOSIA DOMAL GELOSIA 40	PA	500 Pz
---	-----------------------------------	----	-----------

Art. 099990694.0

01

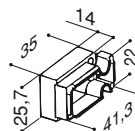

Giunto per profili persiana Joint for shutter profiles Unión para perfiles persiana	DOMAL UNIVERSAL 55 21662 / 21663 - 21675	PA	1.000 Pz
--	---	----	-------------

16

eletto col. nero  
electron col. black  
anodizado col. negro

25

marrone 8014  
brown 8014  
marrone 8014

26

verde 5293  
gothic 5293  
verde 5293

37

ottone  
brass  
ottone

39

nero opaco  
opaque black  
negro opaco

60

verde 5123  
green 5123  
verde 5123

68

grigio 9006  
gothic 9006  
gris 9006

77

cromo  
chrome  
cromo

MO

mogano  
mahogany  
caoba

NO

noce  
walnut  
nogal

RO

rovere  
oak  
roble

Art. 099991896.0 01

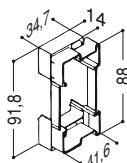

DESCRIZIONE DESCRIPTION DESCRIPCIÓN	APPLICAZIONE APPLICATION APLICACIÓN	MATERIALE MATERIAL MATERIAL	SCATOLA BOX CAJA
Giunto per profili persiana Joint for shutter profiles Unión para perfiles persiana	DOMAL UNIVERSAL 55 21662 / 21663 - 21675	PA	500 Pz

Art. 099991121.0 01

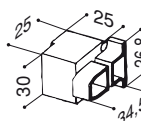

DESCRIZIONE DESCRIPTION DESCRIPCIÓN	APPLICAZIONE APPLICATION APLICACIÓN	MATERIALE MATERIAL MATERIAL	SCATOLA BOX CAJA
Giunto Joint Unión	DOMAL BREAK PA 52 15109 / 15120	PA	1.000 Pz

Art. 099990238.0 01

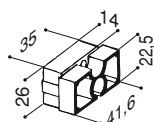

DESCRIZIONE DESCRIPTION DESCRIPCIÓN	APPLICAZIONE APPLICATION APLICACIÓN	MATERIALE MATERIAL MATERIAL	SCATOLA BOX CAJA
Giunto con collegamento ALLIANCE per profili persiana Joint for ALLIANCE connection for shutter profiles Unión con acoplamiento ALLIANCE para perfiles persiana	ALPHA 445 R 40 900396 / 900619 900399 / 900261 / 900409	PA	1.000 Pz

Art. 099990233.0 01

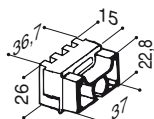

DESCRIZIONE DESCRIPTION DESCRIPCIÓN	APPLICAZIONE APPLICATION APLICACIÓN	MATERIALE MATERIAL MATERIAL	SCATOLA BOX CAJA
Giunto per profili persiana Joint for shutter profiles Unión para perfiles persiana	ALL.CO 5 1144 / 3184 / 1549 / 3184 EKIP 40 - EKIP EVOLUTION ZK 10211 / ZK 8275 / ZK 12035	PA	1.000 Pz

Art. 099992175.0 01

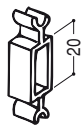

DESCRIZIONE DESCRIPTION DESCRIPCIÓN	APPLICAZIONE APPLICATION APLICACIÓN	MATERIALE MATERIAL MATERIAL	SCATOLA BOX CAJA
Collegamento per giunti cod. 0233 - cod. 0236 Connection for joints code 0233 - code 0236 Acoplamiento para uniones cód. 0233 - cód. 0236	EKIP EVOLUTION ZK 8275 / ZK 12035 ALL.CO VZ 0643	PA	50 Pz

Art. 099990236.0 01

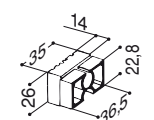

DESCRIZIONE DESCRIPTION DESCRIPCIÓN	APPLICAZIONE APPLICATION APLICACIÓN	MATERIALE MATERIAL MATERIAL	SCATOLA BOX CAJA
Giunto per profili persiana Joint for shutter profiles Unión para perfiles persiana	GR 9 - NC 40 METRA - SYNTHESIS ALL.CO VZ 4274 / VZ 0643 - DOMAL	PP	1.000 Pz

00  
neutro  
neutral  
neutro

01  
nero 9005  
black 9005  
negro 9005

02  
bianco  
white  
blanco

03  
bianco 1013  
white 1013  
blanco 1013

04  
bianco 9010  
white 9010  
blanco 9010

05  
verde  
green  
verde

06  
verde 6005  
green 6005  
verde 6005

07  
marrone  
brown  
marrone

08  
marrone 8017  
brown 8017  
marrone 8017

09  
giallo 1006  
yellow 1006  
amarillo 1006

10  
grigio 7001  
grey 7001  
gris 7001

13  
rosso 3003  
red 3003  
rojo 3003

14  
argento  
silver  
plateado

15  
bronzo  
bronze  
bronce

Art. 099990279.0

01

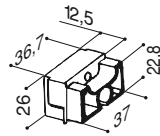

DESCRIZIONE  
DESCRIPTION  
DESCRIPCIÓN

Giunto per profili persiana  
Joint for shutter profiles  
Unión para perfiles persiana

APPLICAZIONE  
APPLICATION  
APLICACIÓN

ALL.CO 1494 / 3184 -  
METRA 3134 / 3138

MATERIALE  
MATERIAL

PA

SCATOLA  
BOX  
CAJA

1.000  
Pz

Art. 099991414.0

01

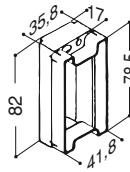

Giunto per profili persiana  
Joint for shutter profiles  
Unión para perfiles persiana

ALL.CO 5 VZ 3608 /  
VZ 3609

PA

500  
Pz

Art. 099991901.0

01

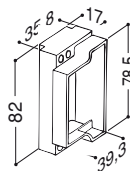

Giunto per profili persiana  
Joint for shutter profiles  
Unión para perfiles persiana

ALL.CO P4 VZ 0747 /  
VZ 0748 - ALL.CO K40 -  
CE 024 / VZ 0748

PA

500  
Pz

Art. 099991413.0

01

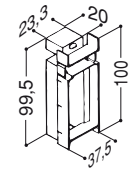

Giunto  
Joint  
Unión

ALL.CO 5 1520 / 5091 /  
5092

PA

500  
Pz

Art. 099991804.0

01

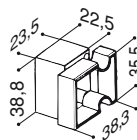

Giunto  
Joint  
Unión

ALL.CO - EXPORT 50  
5097 / 5096

PA

500  
Pz

Art. 099990234.0

01

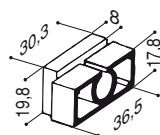

Giunto per profilo persiana  
Joint for shutter profile  
Unión para perfil persiana

METRA - NC 40

PA

500  
Pz

16

eletto col. nero  
electrum col. black  
anodizado col. negro

25

marrone 8014  
brown 8014  
marrone 8014

26

verde 5293  
gothic 5293  
verde 5293

37

ottone  
brass  
ottone

39

nero opaco  
opaque black  
negro opaco

60

verde 5123  
green 5123  
verde 5123

68

grigio 9006  
gothic 9006  
gris 9006

77

cromo  
chrome  
cromo

MO

mogano  
mahogany  
caoba

NO

noce  
walnut  
nogal

RO

rovere  
oak  
roble

Art. 099991670.0	01											DESCRIZIONE DESCRIPTION DESCRIPCIÓN	APPLICAZIONE APPLICATION APLICACIÓN	MATERIALE MATERIAL MATERIAL	SCATOLA BOX CAJA
												Giunto per profili persiana Joint for shutter profiles Unión para perfiles persiana	METRA nuovo - new - nuevo NC 40 3382 / 4359	PA	500 Pz
												Giunto Joint Unión	METRA NC 45 INTERNATIONAL 3462 / 3654 / 3463	PA	1.000 Pz
												Giunto per profilo persiana alla genovese Joint for genovese shutter profile Unión para perfil persiana tipo genovés	METRA 3295	PA	500 Pz
												Giunto per profilo persiana alla genovese Joint for genovese shutter profile Unión para perfil persiana tipo genovés	METRA 3291	PA	1.000 Pz
												Giunto per profili persiana Joint for shutter profiles Unión para perfiles persiana	METRA FIRENZE 4113 / 4026	PA	1.000 Pz
												Giunto per profilo persiana Joint for shutter profile Unión para perfil persiana		PA	500 Pz



00  
neutro  
neutral  
neutro

01  
nero 9005  
black 9005  
negro 9005

02  
bianco  
white  
blanco

03  
bianco 1013  
white 1013  
blanco 1013

04  
bianco 9010  
white 9010  
blanco 9010

05  
verde  
green  
verde

06  
verde 6005  
green 6005  
verde 6005

07  
marrone  
brown  
marrone

08  
marrone 8017  
brown 8017  
marrone 8017

09  
giallo 1006  
yellow 1006  
amarillo 1006

10  
grigio 7001  
grey 7001  
gris 7001

13  
rosso 3003  
red 3003  
rojo 3003

14  
argento  
silver  
plateado

15  
bronzo  
bronze  
bronce

Art. 099992052.0

01

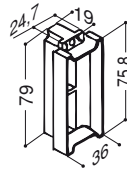

DESCRIZIONE  
DESCRIPTION  
DESCRIPCIÓN

Giunto per profili persiana  
Joint for shutter profiles  
Unión para perfiles persiana

APPLICAZIONE  
APPLICATION  
APLICACIÓN

GOLD 400 40136 /  
40138 / 40075 / 40076

MATERIALE  
MATERIAL  
MATERIAL

PA

SCATOLA  
BOX  
CAJA

500  
Pz

Art. 099991430.0

01

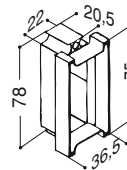

Giunto per profilo persiana  
movimento  
METALTECNICA  
Joint for shutter profile,  
METALTECNICA movement  
Unión para perfil persiana  
movimiento  
METALTECNICA

PA

500  
Pz

Art. 099991807.0

01

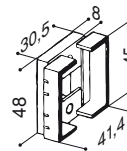

Giunto per profilo persiana  
Joint for shutter profile  
Unión para perfil persiana

RIVIERA

PA

100  
Pz

Art. 099991806.0

01

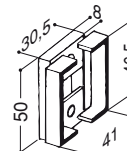

Giunto per profilo persiana  
Joint for shutter profile  
Unión para perfil persiana

FB 12 a scomparsa  
hidden - occultable

PA

1.000  
Pz

Art. 099990294.0

01

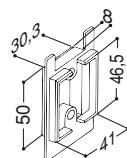

Giunto per profilo persiana  
Joint for shutter profile  
Unión para perfil persiana

FB 12

PA

1.000  
Pz

Art. 099991127.0

01

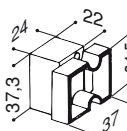

Giunto  
Joint  
Unión









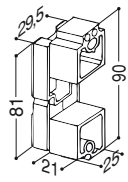

R 40 800327 / 800325 -  
800326 / 800331

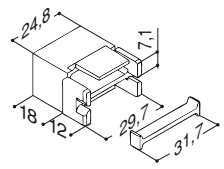
PA

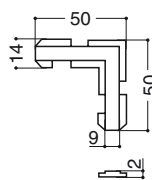
500  
Pz

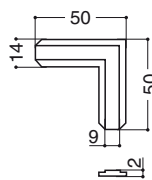
Art. 099991963.0	01									DESCRIZIONE DESCRIPTION DESCRIPCIÓN	APPLICAZIONE APPLICATION APLICACIÓN	MATERIALE MATERIAL MATERIAL	SCATOLA BOX CAJA
										Giunto per profili persiana Joint for shutter profiles Unión para perfiles persiana	R 40 900621 / 800365 REVAMPING	PA	1.000 Pz
										Giunto per profili persiana Joint for shutter profiles Unión para perfiles persiana	EKU 53 T.E.S. 5680 / 5681	PA	500 Pz
										Giunto per profili persiana Joint for shutter profiles Unión para perfiles persiana	GLOBAL AS 4580 / 4517	PA	2.000 Pz
										Giunto Joint Unión	EKU 53 T.E.S. 4264 / 4276 - 4277 / 4278	PA	500 Pz
										Giunto per profili persiana Joint for shutter profiles Unión para perfiles persiana	INDINVEST serie - series - serie GOLD 400 40073 / 40072	PA	500 Pz
										Giunto per profili persiana Joint for shutter profiles Unión para perfiles persiana	INDINVEST serie - series - serie GOLD 400 40109 / 40110	PA	1.000 Pz

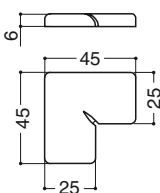
00	01	02	03	04	05	06	07	08	09	10	13	14	15
neutro neutral neutro	nero 9005 black 9005 negro 9005	bianco white blanco	bianco 1013 white 1013 blanco 1013	bianco 9010 white 9010 blanco 9010	verde green verde	verde 6005 green 6005 verde 6005	marone brown marone	marone 8017 brown 8017 marone 8017	giallo 1006 yellow 1006 amarillo 1006	grigio 7001 grey 7001 gris 7001	rosso 3003 red 3003 rojo 3003	argento silver plateado	bronzo bronze bronce

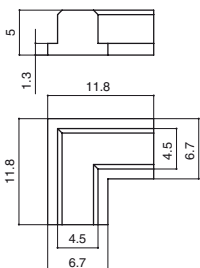
Art. 099992066.0	01					DESCRIZIONE DESCRIPTION DESCRIPCIÓN	APPLICAZIONE APPLICATION APLICACIÓN	MATERIALE MATERIAL MATERIAL	SCATOLA BOX CAJA
						Giunto Joint Unión	INDINVEST serie - series - serie GOLD 400-500 40107 / 50049 40171 / 40172	PA	500 Pz
						Giunto con spessore Joint with thickness Unión con espesores	nuovo - new - nuevo NC - ETNALL ET43 - ATLANTIS serie - series - serie 40 - G40	PA	200 Pz
						Squadretta di allineamento Alignment bracket Escuadra de alineación	R 40	PA	2.000 Pz
						Squadretta di allineamento chiusa Close alignment bracket Escuadra de alineación cerrada	R 40	PA	2.000 Pz
						Squadretta di allineamento Alignment bracket Escuadra de alineación	R 40 - R 50	PA	500 Pz
						Squadretta di allineamento alette Alignment bracket of flaps Escuadra de alineación aletas	ALL.CO 5 - ALL.CO P4	PA	5.000 Pz

Art. 099992840.0	01	DESCRIZIONE DESCRIPTION DESCRIPCIÓN	APPLICAZIONE APPLICATION APLICACIÓN	MATERIALE MATERIAL MATERIAL	SCATOLA BOX CAJA
		Squadretta di allineamento Alignment bracket Escuadra de alineación	ETNALL ET4322 G40/G2019 ATLANTIS AZ 2109	PA	3.500 Pz
		Riduttore per squadretta Reducer for corner joint Espesor escuadra rotura puente termico	PA	10.000 Pz	
		Blocchetto sostegno piastra cerniera Support block of hinge plate Bloque soporte placa bisagra	ALL CO WOOD	PA	1.000 Pz
		Coppia blocchetto cremonese Pair of cremone blocks Juego conexión cremona	R 40 - NEW TEC - NEW 50 / 52 TT / 60 TT	PA	1.000 coppie pairs pajeras
		Coppia blocchetto cremonese maggiorato Pair of extended cremone blocks Juego conexión cremona sobredimensionado		PA	1.000 coppie pairs pajeras
		Coppia blocchetto cre- monese Pair of cremone blocks Juego conexión cremona	DOMAL BREAK / GELOSIA / STOPPER PG - GOLD - ALL CO K40 / 5TT / P4 / EXPORT - EKIP 40 - nuovo new nuovo NC 40	PA	1.000 coppie pairs pajeras

<b>00</b> neutro neutral neutro	<b>01</b> nero 9005 black 9005 negro 9005	<b>02</b> bianco white blanco	<b>03</b> bianco 1013 white 1013 blanco 1013	<b>04</b> bianco 9010 white 9010 blanco 9010	<b>05</b> verde green verde	<b>06</b> verde 6005 green 6005 verde 6005	<b>07</b> marone brown marone	<b>08</b> marone 8017 brown 8017 marone 8017	<b>09</b> giallo 1006 yellow 1006 amarillo 1006	<b>10</b> grigio 7001 grey 7001 gris 7001	<b>13</b> rosso 3003 red 3003 rojo 3003	<b>14</b> argento silver plateado	<b>15</b> bronzo bronze bronce
--	--	--	---	---	--------------------------------------	---	--	---	--	--	--	--	---

Art. 09992764.0

01

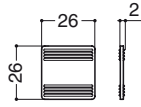

DESCRIZIONE DESCRIPTION DESCRIPCIÓN	APPLICAZIONE APPLICATION APLICACIÓN	MATERIALE MATERIAL MATERIAL	SCATOLA BOX CAJA
Spessori caricavetro ANGEL da mm 2 Glass loader thicknesses, ANGEL 2 mm Espesores carga cristal ANGEL de 2 mm	R 40 REVAMPING - R 50 TT	PP	1.000 Pz

Art. 09992765.0

01

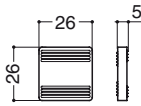

Spessori caricavetro ANGEL da mm 5 Glass loader thicknesses, ANGEL 5 mm Espesores carga cristal ANGEL de 5 mm	R 40 REVAMPING - R 50 TT	PP	1.000 Pz
--	--------------------------	----	-------------

Art. 09992766.0

01

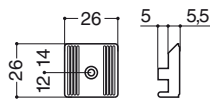

Spessori caricavetro ANGEL da mm 5,5 con foro Glass loader thicknesses, ANGEL 5,5 mm Espesores carga cristal ANGEL de 5,5 mm con orificio	R 40 REVAMPING - R 50 TT	PP	1.000 Pz
--	--------------------------	----	-------------

Art. 09992798.0

01

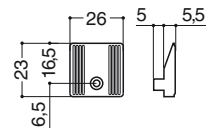

Spessori caricavetro ANGEL da mm 5,5 con foro Glass loader thicknesses, ANGEL 5,5 mm Espesores carga cristal ANGEL de 5,5 mm con orificio	R 40 - R 50 giunto aperto	PP	500 Pz
--	---------------------------	----	-----------

Art. 09992767.0

01

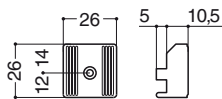

Spessori caricavetro ANGEL da mm 10,5 con foro Glass loader thicknesses, ANGEL 10,5 mm with hole Espesores carga cristal ANGEL de 10,5 mm con orificio	R 40 REVAMPING - R 50 TT	PP	1.000 Pz
--	--------------------------	----	-------------

Art. 09992862.0

09

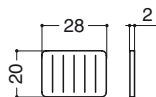

Spessore zigrinato per vetrocamera mm 20x2 Milled thickness for glass camera 20x2 mm Espesor moleteado para cámara vidrio 20x2 mm		PP	25 kg
--	--	----	----------

**16**  
 elettro col. nero  
 electrum col. black  
 anodizado col. negro

**25**  
 marrone 8014  
 brown 8014  
 marrone 8014

**26**  
 verde 5293  
 gothic 5293  
 verde 5293

**37**  
 ottone  
 brass  
 ottone

**39**  
 nero opaco  
 opaque black  
 negro opaco

**60**  
 verde 5123  
 green 5123  
 verde 5123









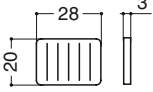

**68**  
 grigio 9006  
 gothic 9006  
 gris 9006

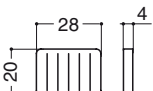
**77**  
 cromo  
 chrome  
 cromo

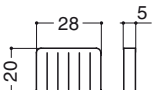

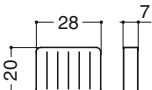

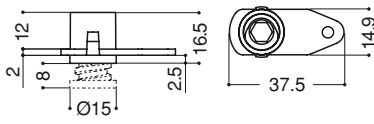

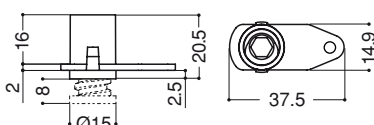

**MO**  
 mogano  
 mahogany  
 caoba

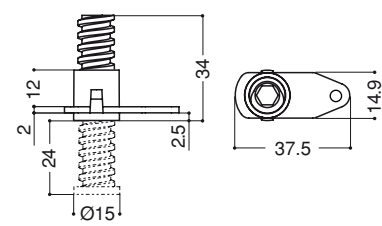
**NO**  
 noce  
 walnut  
 nogal

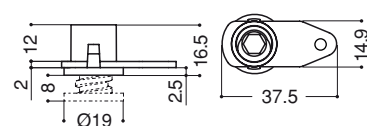
**RO**  
 rovere  
 oak  
 roble

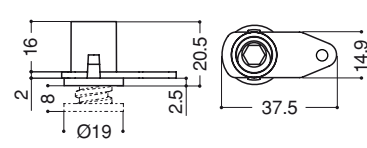
Art. 099992863.0	13									DESCRIZIONE DESCRIPTION DESCRIPCION	APPLICAZIONE APPLICATION APLICACION	MATERIALE MATERIAL MATERIAL	SCATOLA BOX CAJA
										Spessore zigrinato per vetrocamera mm 20x3 Milled thickness for glass camera 20x3 mm Espesor moleteado para cámara vidrio 20x3 mm		PP	25 Kg
										Spessore zigrinato per vetrocamera mm 20x4 Milled thickness for glass camera 20x4 mm Espesor moleteado para cámara vidrio 20x4 mm		PP	25 Kg
										Spessore zigrinato per vetrocamera mm 20x5 Milled thickness for glass camera 20x5 mm Espesor moleteado para cámara vidrio 20x5 mm		PP	25 Kg
										Spessore zigrinato per vetrocamera mm 20x7 Milled thickness for glass camera 20x7 mm Espesor moleteado para cámara vidrio 20x7 mm		PP	25 Kg
										Distanziatore da mm Ø 15x16,5 Spacer from Ø 15x16,5 mm Distanciadør Ø 15x16,5 mm	R 40 - R 50 - ALL.CO 5 - ALL.CO P4 ALPHA 445 / 545 / 658 TT	PA	1.000 Pz
										Distanziatore da mm Ø 15x20,5 Spacer from Ø 15x20,5 mm Distanciadør Ø 15x20,5 mm	nuovo - new - nuevo NC 40 NC 45 INTERNATIONAL EKIP - EXPORT DOMAL STOPPER	PA	1.000 Pz

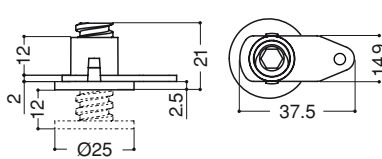
<b>00</b> neutro neutral neutro	<b>01</b> nero 9005 black 9005 negro 9005	<b>02</b> bianco white blanco	<b>03</b> bianco 1013 white 1013 blanco 1013	<b>04</b> bianco 9010 white 9010 blanco 9010	<b>05</b> verde green verde	<b>06</b> verde 6005 green 6005 verde 6005	<b>07</b> marrone brown marrone	<b>08</b> marrone 8017 brown 8017 marrone 8017	<b>09</b> giallo 1006 yellow 1006 amarillo 1006	<b>10</b> grigio 7001 grey 7001 gris 7001	<b>13</b> rosso 3003 red 3003 rojo 3003	<b>14</b> argento silver plateado	<b>15</b> bronzo bronze bronce
--	--	--	---	---	--------------------------------------	---	--	---	--	--	--	--	---

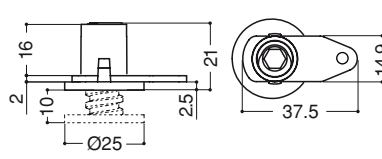
Art. 099992971.0	01	DESCRIZIONE DESCRIPTION DESCRIPCIÓN	APPLICAZIONE APPLICATION APLICACIÓN	MATERIALE MATERIAL	SCATOLA BOX CAJA
		Distanziatore da mm Ø 15x34 Spacer from Ø 15x34 mm Distanciadør Ø 15x34 mm	universale - universal - universal	PA	1.000 Pz
		Distanziatore da mm Ø 19x16,5 Spacer from Ø 19x16,5 mm Distanciadør Ø 19x16,5 mm	TRIALCO - ALL.CO 5	PA	1.000 Pz
		Distanziatore da mm Ø 19x20,5 Spacer from Ø 19x20,5 mm Distanciadør Ø 19x20,5 mm	ESA	PA	1.000 Pz
		Distanziatore da mm Ø 25x21 Spacer from Ø 25x21 mm Distanciadør Ø 25x21 mm	ESEDRA - EXPORT ALL.CO 5	PA	1.000 Pz
		Distanziatore da mm Ø 25x21 Spacer from Ø 25x21 mm Distanciadør Ø 25x21 mm	universale - universal - universal	PA	1.000 Pz

16  
 elettro col. nero  
 electrum col. black  
 anodizado col. negro

25  
 marrone 8014  
 brown 8014  
 marrone 8014

26  
 verde 5293  
 gothic 5293  
 verde 5293

37  
 ottone  
 brass  
 ottone

39  
 nero opaco  
 opaque black  
 negro opaco

60  
 verde 5123  
 green 5123  
 verde 5123





68  
 grigio 9006  
 gothic 9006  
 gris 9006

77  
 cromo  
 chrome  
 cromo

MO  
 mogano  
 mahogany  
 caoba

NO  
 noce  
 walnut  
 nogal

RO  
 rovere  
 oak  
 roble

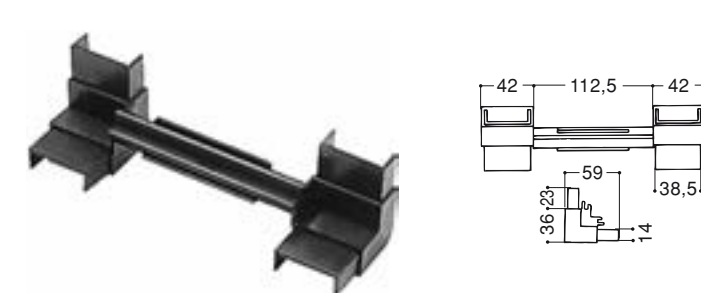
Art. 09992917.0 00	DESCRIZIONE DESCRIPTION DESCRIPCIÓN	MATERIALE MATERIAL MATERIALE	SCATOLA BOX CAJA
	<p>Spessori da mm 2 per telaio / controtelaio 2 mm thicknesses for frame / counterframe Espesores de 2 mm para marco y contramarco</p>	PE	1.000 pz. in stecche da 4
	<p>Spessori da mm 3 per telaio / controtelaio 3 mm thicknesses for frame / counterframe Espesores de 3 mm para marco y contramarco</p>	PE	800 pz. in stecche da 4
	<p>Spessori da mm 4 per telaio / controtelaio 4 mm thicknesses for frame / counterframe Espesores de 4 mm para marco y contramarco</p>	PE	600 pz. in stecche da 4
	<p>Spessori da mm 5 per telaio / controtelaio 5 mm thicknesses for frame / counterframe Espesores de 5 mm para marco y contramarco</p>	PE	500 pz. in stecche da 4
	<p>Angolo di giunzione per imbotte in alluminio Junction corner for aluminium soffit Unión angular para intradós de aluminio</p>	PA	200 Pz



00	01	02	03	04	05	06	07	08	09	10	13	14	15
neutro neutral neutro	nero 9005 black 9005 negro 9005	bianco white blanco	bianco 1013 white 1013 blanco 1013	bianco 9010 white 9010 blanco 9010	verde green verde	verde 6005 green 6005 verde 6005	marone brown marone	marone 8017 brown 8017 marone 8017	giallo 1006 yellow 1006 amarillo 1006	grigio 7001 grey 7001 gris 7001	rosso 3003 red 3003 rojo 3003	argento silver plateado	bronzo bronze bronce

Art. 099991100.0 01

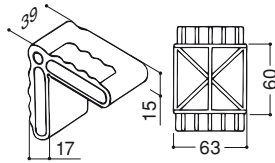

DESCRIZIONE DESCRIPTION DESCRIPCIÓN	MATERIALE MATERIAL MATERIALE	SCATOLA BOX CAJA
<p>Angolo di giunzione per controtelaio in lamiera zincata completo di prolunghe da mm 60 (lunghezza totale mm 138)</p> <p>Junction corner for counter frame in galvanized plate, provided with 60 mm extensions (total length 138 mm)</p> <p>Unión angular para contramarco en chapa cincada, con extensiones de 60 mm (longitud total 138 mm)</p>	PP	10 Kit

Art. 099991101.0 01

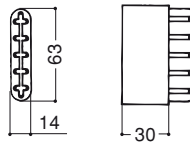

<p>Prolunga mm 30 angolo di giunzione per controtelaio in lamiera zincata</p> <p>Extensions 30 mm junction corner for counterframe in galvanized plate</p> <p>Extensiones 30 mm unión angular para contramarco en chapa cincada</p>	PP	20 coppie pairs parejas
---	----	----------------------------------

Art. 099991102.0 01

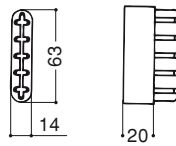

<p>Prolunga mm 20 angolo di giunzione per controtelaio in lamiera zincata</p> <p>Extensions 20 mm junction corner for counterframe in galvanized plate</p> <p>Extensiones 20 mm unión angular para contramarco en chapa cincada</p>	PP	20 coppie pairs parejas
---	----	----------------------------------

Art. 099991800.0 01

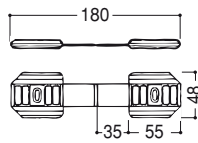

<p>Spessore angolare per vetro infilare</p> <p>Angular thickness for thread glass</p> <p>Espesor angular para cristal inserción</p>	PA	500 Pz
---	----	-----------

Art. 099991863.0 01

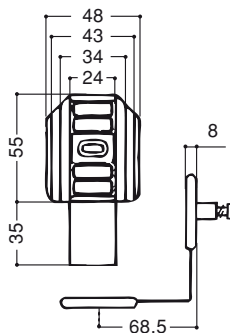

<p>Kit spessore angolare per vetro infilare e registro con vite da mm 10</p> <p>Kit for angular thickness for thread glass and register with 10 mm screw</p> <p>Kit espesor angular para cristal inserción con tornillo de registro de 10 mm</p>	PA	50 Pz cod. 1837  100 Pz cod. 1800
--	----	---

16  
 elettro col. nero  
 electrum col. black  
 anodizado col. negro

25  
 marrone 8014  
 brown 8014  
 marrone 8014

26  
 verde 5293  
 gothic 5293  
 verde 5293

37  
 ottone  
 brass  
 ottone

39  
 nero opaco  
 opaque black  
 negro opaco

60  
 verde 5123  
 green 5123  
 verde 5123

68  
 grigio 9006  
 gothic 9006  
 gris 9006

77  
 cromo  
 chrome  
 cromo

MO  
 mogano  
 mahogany  
 caoba

NO  
 noce  
 walnut  
 nogal

RO  
 rovere  
 oak  
 roble

Art. 099991864.0 01	DESCRIZIONE DESCRIPTION DESCRIPCIÓN	MATERIALE MATERIAL MATERIALE	SCATOLA BOX CAJA
	<p>Kit spessore angolare per vetro infilare e registro con vite da mm 18                      Kit for angular thickness for thread glass and register with 18 mm screw                      Kit espesor angular para cristal inserción con tornillo de registro de 18 mm</p>	<p>PA</p>	<p>50                      Pz                      cod. 1841                      100                      Pz                      cod. 1800</p>
	<p>Registro con vite da mm 10                      Register with screw with 10 mm screw                      Registro con tornillo de 10 mm</p>	<p>PA</p>	<p>500                      Pz</p>
	<p>Registro con vite da mm 18                      Register with 18 mm screw                      Registro con tornillo de 18 mm</p>	<p>PA</p>	<p>500                      Pz</p>
	<p>Piastrino piccolo per registro telaio a infilare                      Small plate for thread frame register                      Placa pequeña para registro marco inserción</p>	<p>ZAMA                      ZAMAK</p>	
	<p>Piastrino piccolo per registro telaio a scatto                      Locking small plate for frame register                      Placa pequeña para registro marco con bloqueo automático</p>	<p>ZAMA                      ZAMAK</p>	

00  
neutro  
neutral  
neutro

01  
nero 9005  
black 9005  
negro 9005

02  
bianco  
white  
blanco

03  
bianco 1013  
white 1013  
blanco 1013

04  
bianco 9010  
white 9010  
blanco 9010

05  
verde  
green  
verde

06  
verde 6005  
green 6005  
verde 6005

07  
marrone  
brown  
marrone

08  
marrone 8017  
brown 8017  
marrone 8017

09  
giallo 1006  
yellow 1006  
amarillo 1006

10  
grigio 7001  
grey 7001  
gris 7001

13  
rosso 3003  
red 3003  
rojo 3003

14  
argento  
silver  
plateado

15  
bronz  
bronze  
bronce

Art. 699992943.0 00

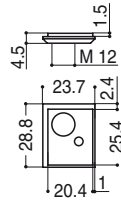

DESCRIZIONE DESCRIPTION DESCRIPCIÓN	MATERIALE MATERIAL MATERIALE	SCATOLA BOX CAJA
<p>Piastrino grande per registro telaio a scatto</p> <p>Locking big plate for frame register</p> <p>Placa grande para registro marco con bloqueo automático</p>	ZAMA ZAMAK	

Art. 699992944.0 00

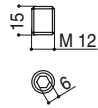

<p>Vite senza testa M12 x 15 per registro telaio</p> <p>Headless screw M12 x 15 for frame register</p> <p>Tornillo sin cabeza M12 x 15 para registro marco</p>	AL	
--	----	--

Art. 699992945.0 00

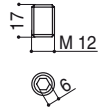

<p>Vite senza testa M12 x 17 per registro telaio</p> <p>Headless screw M12 x 17 for frame register</p> <p>Tornillo sin cabeza M12 x 17 para registro marco</p>	AL	
--	----	--

Art. 699992946.0 00

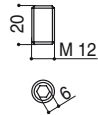

<p>Vite senza testa M12 x 20 per registro telaio</p> <p>Headless screw M12 x 20 for frame register</p> <p>Tornillo sin cabeza M12 x 20 para registro marco</p>	AL	
--	----	--

Art. 699992947.0 00

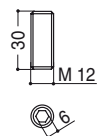

<p>Vite senza testa M12 x 30 per registro telaio</p> <p>Headless screw M12 x 30 for frame register</p> <p>Tornillo sin cabeza M12 x 30 para registro marco</p>	AL	
--	----	--

16  
 elettro col. nero  
 electrum col. black  
 anodizado col. negro

25  
 marrone 8014  
 brown 8014  
 marrone 8014

26  
 verde 5293  
 gothic 5293  
 verde 5293

37  
 ottone  
 brass  
 ottone

39  
 nero opaco  
 opaque black  
 negro opaco

60  
 verde 5123  
 green 5123  
 verde 5123



68  
 grigio 9006  
 gothic 9006  
 gris 9006

77  
 cromo  
 chrome  
 cromo

MO  
 mogano  
 mahogany  
 caoba

NO  
 noce  
 walnut  
 nogal

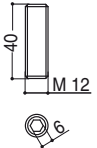
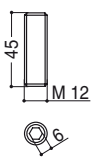
RO  
 rovere  
 oak  
 roble

Art. 699992948.0 00	DESCRIZIONE DESCRIPTION DESCRIPCIÓN	MATERIALE MATERIAL MATERIALE	SCATOLA BOX CAJA
 	<p>Vite senza testa M12 x 40 per registro telaio                      Headless screw M12 x 40 for frame register                      Tornillo sin cabeza M12 x 40 para registro marco</p>	AL	
 	<p>Vite senza testa M12 x 45 per registro telaio                      Headless screw M12 x 45 for frame register                      Tornillo sin cabeza M12 x 45 para registro marco</p>	AL	
 	<p>Vite senza testa M12 x 60 per registro telaio                      Headless screw M12 x 60 for frame register                      Tornillo sin cabeza M12 x 60 para registro marco</p>	AL	
	<p>Squadretta polivalente per zanzariera asimmetrica sistema scorrevole o saliscendi con viti M5 x 9,5 (Brevettata)                      All-purpose angle cleat for asymmetric mosquito net, sliding system or latch with M5 x 9,5 screws (Patented)                      Escuadra polivalente para mosquitera asimétrico, corredera horizontal o vertical, con mosquitera M5 x 9,5 (Patentada)</p>	PA	200 Pz
	<p>Squadretta polivalente per zanzariera asimmetrica sistema scorrevole o saliscendi con viti M5 x 11,4 (Brevettata)                      All-purpose angle cleat for asymmetric mosquito net, sliding system or latch with M5 x 11,4 screws (Patented)                      Escuadra polivalente para mosquitera asimétrico, corredera horizontal o vertical, con tornillos M5 x 11,4 (Patentada)</p>	PA	200 Pz

00	01	02	03	04	05	06	07	08	09	10	13	14	15
neutro neutral neutro	nero 9005 black 9005 negro 9005	bianco white blanco	bianco 1013 white 1013 blanco 1013	bianco 9010 white 9010 blanco 9010	verde green verde	verde 6005 green 6005 verde 6005	marone brown marone	marone 8017 brown 8017 marone 8017	giallo 1006 yellow 1006 amarillo 1006	grigio 7001 grey 7001 gris 7001	rosso 3003 red 3003 rojo 3003	argento silver plateado	bronzo bronze bronce

Art. 099992897.0 01

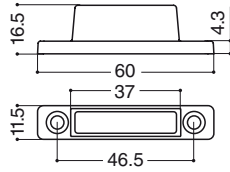

DESCRIZIONE DESCRIPTION DESCRIPCIÓN	MATERIALE MATERIAL MATERIALE	SCATOLA BOX CAJA
Maniglia zanzariera per scorrevole e saliscendi Mosquito net handle for sliding system or latch Manilla mosquitera para corredera horizontal o vertical	PA	1.000 Pz

Art. 099992158.0 01



Rotella per squadretta zanzariera sistema scorrevole Roller for angle cleat for mosquito net with sliding system Rueda para escuadra mosquitera sistema corredera horizontal	PA	100 Pz
--	----	-----------

Art. 099992159.0 01



Frizione a due molle e compensatore per squadretta zanzariera simmetrica sistema saliscendi Two spring clutch and compensator for angle cleat for symmetric mosquito net with latch system Fricción de dos muelles y compensador para escuadra mosquitera asimétrico sistema corredera vertical	PA	100 Pz
---	----	-----------

Art. 099992886.0 03

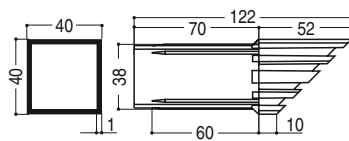

Tappo a saldare per infissi in PVC con tubolare da mm. 40x40x1 Seal plug for PVC fixtures with 40x40x1 mm tubing Tapón de soldar para cerramientos en PVC con perfil tubular de 40x40x1 mm	PVC	250 Pz
--	-----	-----------

Art. 099992867.0 03

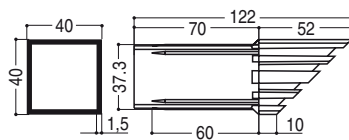

Tappo a saldare per infissi in PVC con tubolare da mm. 40x40x1,5 Seal plug for PVC fixtures with 40x40x1.5 mm tubing Tapón de soldar para cerramientos en PVC con perfil tubular de 40x40x1,5 mm	PVC	250 Pz
--	-----	-----------

16  
 elettro col. nero  
 electrum col. black  
 anodizado col. negro

25  
 marrone 8014  
 brown 8014  
 marrone 8014

26  
 verde 5293  
 gothic 5293  
 verde 5293

37  
 ottone  
 brass  
 ottone

39  
 nero opaco  
 opaque black  
 negro opaco

60  
 verde 5123  
 green 5123  
 verde 5123

68  
 grigio 9006  
 gothic 9006  
 gris 9006

77  
 cromo  
 chrome  
 cromo

MO  
 mogano  
 mahogany  
 caoba

NO  
 noce  
 walnut  
 nogal

RO  
 rovere  
 oak  
 roble

Art. 099992874.0 03

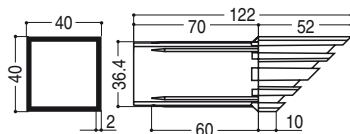

DESCRIZIONE  
 DESCRIPTION  
 DESCRIPCIÓN

Tappo a saldare per infissi in PVC con tubolare da mm. 40x40x2  
 Seal plug for PVC fixtures with 40x40x2 mm tubing  
 Tapón de soldar para cerramientos en PVC con perfil tubular de 40x40x2 mm

MATERIALE  
 MATERIAL  
 MATERIALE

PVC

SCATOLA  
 BOX  
 CAJA

250  
 Pz

Art. 099992060.0 01

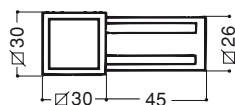

Raccordo 30x30 a due vie  
 Two-way 30x30 fitting  
 Empalme 30x30 de dos vías

PA

50  
 Pz

Art. 099992061.0 01

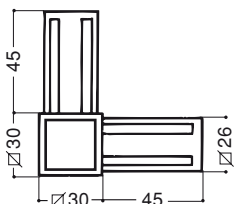

Raccordo 30x30 a tre vie  
 Three-way 30x30 fitting  
 Empalme 30x30 de tres vías

PA

50  
 Pz

Art. 099992062.0 01

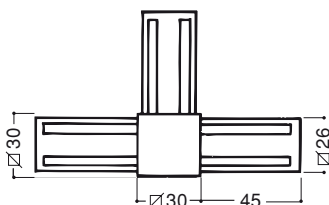

Raccordo 30x30 a quattro vie  
 Four-way 30x30 fitting  
 Empalme 30x30 de cuatro vías

PA

50  
 Pz

Art. 099992063.0 01

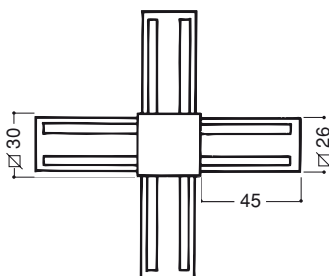

Raccordo 30x30 a cinque vie  
 Five-way 30x30 fitting  
 Empalme 30x30 de cinco vías

PA

50  
 Pz



# ARTICOLI COMMERCIALIZZATI



COMMERCIALIZED  
ARTICLE

ARTICULO  
COMERCIALIZADO





00  
neutro  
neutral  
neutro

01  
nero 9005  
black 9005  
negro 9005

02  
bianco  
white  
blanco

03  
bianco 1013  
white 1013  
blanco 1013

04  
bianco 9010  
white 9010  
blanco 9010

05  
verde  
green  
verde

06  
verde 6005  
green 6005  
verde 6005

07  
marrone  
brown  
marrone

08  
marrone 8017  
brown 8017  
marrone 8017

09  
giallo 1006  
yellow 1006  
amarillo 1006

10  
grigio 7001  
grey 7001  
gris 7001

13  
rosso 3003  
red 3003  
rojo 3003

14  
argento  
silver  
plateado

15  
bronz  
bronze  
bronce

Art. 699990156.0 01



DESCRIZIONE DESCRIPTION DESCRIPCIÓN	APPLICAZIONE APPLICATION APLICACIÓN	MATERIALE MATERIAL	SCATOLA BOX CAJA
Riscontro a scatto Release striker Encaje resorte	GR 9	PA	

Art. 699990169.0 01



Riscontro a scatto Release striker Encaje resorte	NC	PA	
---	----	----	--

Art. 699990176.0 01



Riscontro universale Universal striker Encaje universal		PA	
---	--	----	--

Art. 699990157.0 01



Copriangolo Angle cover Cubre ángulo	GR 9	PA	
--	------	----	--

Art. 699990158.0 01



Copriangolo Angle cover Cubre ángulo	NC 40-50	PA	
--	----------	----	--

Art. 699990178.0 01



Copribattuta Ledge cover Paragolpe	GR 9	PA	
--	------	----	--

16

eletto col. nero  
electrum col. black  
anodizado col. negro

25

marrone 8014  
brown 8014  
marrone 8014

26

verde 5293  
gothic 5293  
verde 5293

37

ottone  
brass  
ottone

39

nero opaco  
opaque black  
negro opaco

60

verde 5123  
green 5123  
verde 5123

68

grigio 9006  
gothic 9006  
gris 9006

77

cromo  
chrome  
cromo

MO



mogano  
mahogany  
caoba

NO

noce  
walnut  
nogal

RO

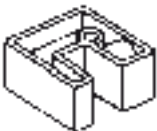
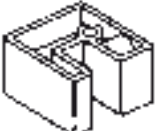
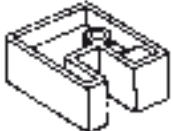
rovere  
oak  
roble

DESCRIZIONE DESCRIPTION DESCRIPCIÓN	APPLICAZIONE APPLICATION APLICACIÓN	MATERIALE MATERIAL MATERIAL	SCATOLA BOX CAJA
<p><b>Art. 699990179.0</b> 01</p>  <p>Copribattuta Ledge cover Paragolpe</p>	NC 40-50	PA	
<p><b>Art. 699990155.0</b> 01</p>  <p>Blocchetto guida 40x18 Guide block 40x18 Bloque guía 40X18</p>		PA	
<p><b>Art. 699990185.0</b> 01</p>  <p>Blocchetto guida 40x19 Guide block 40 x19 Bloque guía 40X19</p>	GR 9	PA	
<p><b>Art. 699990172.0</b> 01</p>  <p>Blocchetto guida 50x25 Guide block 50x25 Bloque guía 50X25</p>		PA	
<p><b>Art. 699990160.0</b> 01 02 05 07 10 15</p>  <p>Tappo copriforo Ø 12 Coverhole plug Ø 12 Tapón Ø 12</p>		PVC	
<p><b>Art. 699990161.0</b> 01 02 05 07 10 15</p>  <p>Tappo copriforo Ø 14 Coverhole plug Ø 14 Tapón Ø 14</p>		PVC	

00  
neutro  
neutral  
neutro

01  
nero 9005  
black 9005  
negro 9005

02  
bianco  
white  
blanco

03  
bianco 1013  
white 1013  
blanco 1013

04  
bianco 9010  
white 9010  
blanco 9010

05  
verde  
green  
verde

06  
verde 6005  
green 6005  
verde 6005

07  
marrone  
brown  
marrone

08  
marrone 8017  
brown 8017  
marrone 8017

09  
giallo 1006  
yellow 1006  
amarillo 1006

10  
grigio 7001  
grey 7001  
gris 7001

13  
rosso 3003  
red 3003  
rojo 3003

14  
argento  
silver  
plateado

15  
bronz  
bronze  
bronce

Art. 699990189.0 01



DESCRIZIONE DESCRIPTION DESCRIPCIÓN	APPLICAZIONE APPLICATION APLICACIÓN	MATERIALE MATERIAL MATERIAL	SCATOLA BOX CAJA
Boccola per riscontro Ø 6 Striker bushing Ø 6 Casquillo para encaje Ø 6		PA	

Art. 699990173.0 01



Rondella cerniera diametro interno mm 11 Hinge washer internal diameter 11 mm Perno bisagra 11 mm		PA	
---	--	----	--

Art. 699991510.0 01



Perno cerniera Ø 11 Hinge pin Ø 11 Perno bisagra Ø 11		PA	
---	--	----	--

Art. 699991514.0 01



Tappo per cerniera Ø 11 Plug for hinge Ø 11 Tapón para bisagra Ø 11		PA	
---	--	----	--

Art. 699990149.3 01 04



Coppia ganci per tenda Pair of hooks for curtain Pareja de ganchos para cortina		PA	
---	--	----	--

Art. 699990167.0 01

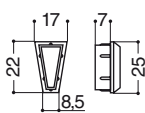
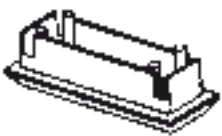

Tappi corrimano Handrail plugs Tapones pasamano		PS	1.000 Pz.
---	--	----	--------------

Art. 699990129.0	01										DESCRIZIONE DESCRIPTION DESCRIPCIÓN	APPLICAZIONE APPLICATION APLICACIÓN	MATERIALE MATERIAL MATERIAL	SCATOLA BOX CAJA
											Tappo semitondo piccolo Small half-round plug Tapón semirredondo pequeño		PS	
											Tappo trapezoidale grande Big trapezoidal plug Tapón trapezoidal grande		PS	
											Tappo trapezoidale piccolo Small trapezoidal plug Tapón trapezoidal pequeño		PS	
											Tappo 15x20 Plug 15x20 Tapón 15x20		PS	
											Tappo 15x30 Plug 15x30 Tapón 15x30		PS	
											Tappo 15x80 Plug 15x80 Tapón 15x80		PS	

00  
neutro  
neutral  
neutro

01  
nero 9005  
black 9005  
negro 9005

02  
bianco  
white  
blanco

03  
bianco 1013  
white 1013  
blanco 1013

04  
bianco 9010  
white 9010  
blanco 9010

05  
verde  
green  
verde

06  
verde 6005  
green 6005  
verde 6005

07  
marrone  
brown  
marrone

08  
marrone 8017  
brown 8017  
marrone 8017

09  
giallo 1006  
yellow 1006  
amarillo 1006

10  
grigio 7001  
grey 7001  
gris 7001

13  
rosso 3003  
red 3003  
rojo 3003

14  
argento  
silver  
plateado

15  
bronz  
bronze  
bronce

Art. 699990159.0 01



DESCRIZIONE DESCRIPTION DESCRIPCIÓN	APPLICAZIONE APPLICATION APLICACIÓN	MATERIALE MATERIAL MATERIAL	SCATOLA BOX CAJA
Tappo 20x10 Plug 20x10 Tapón 20x10		PS	

Art. 699990166.0 01



Tappo 20x20 Plug 20x20 Tapón 20x20		PS	
--	--	----	--

Art. 699990174.0 01



Tappo 20x80 Plug 20x80 Tapón 20x80		PS	
--	--	----	--

Art. 699990184.0 01

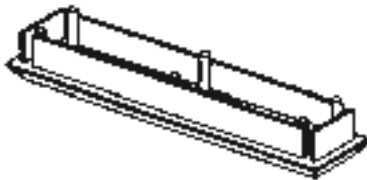

Tappo 20x100 Plug 20x100 Tapón 20x100		PS	
---	--	----	--

Art. 699990164.0 01



Tappo 25x25 Plug 25x25 Tapón 25x25		PS	
--	--	----	--

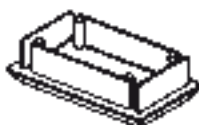

Art. 699990824.0 01



Tappo 25x50 Plug 25x50 Tapón 25x50		PS	
--	--	----	--

DESCRIZIONE DESCRIPTION DESCRIPCIÓN	APPLICAZIONE APPLICATION APLICACIÓN	MATERIALE MATERIAL MATERIAL	SCATOLA BOX CAJA
<p><b>Art. 699990180.0</b> 01</p>  <p>Tappo 30x20 Plug 30x20 Tapón 30x20</p>		PS	
<p><b>Art. 699990165.0</b> 01</p>  <p>Tappo 30x30 Plug 30x30 Tapón 30x30</p>		PS	
<p><b>Art. 699990182.0</b> 01</p>  <p>Tappo 30x60 Plug 30x60 Tapón 30x60</p>		PS	
<p><b>Art. 699990168.0</b> 01</p>  <p>Tappo 40x20 Plug 40x20 Tapón 40x20</p>		PS	
<p><b>Art. 699990188.0</b> 01</p>  <p>Tappo 40x40 Plug 40x40 Tapón 40x40</p>		PS	
<p><b>Art. 699990175.0</b> 01</p>  <p>Tappo 40x60 Plug 40x60 Tapón 40x60</p>		PS	

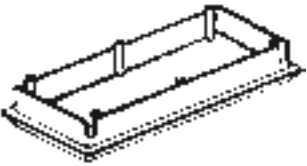
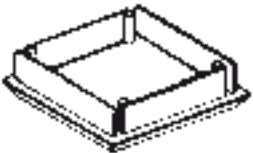
00 neutro neutral neutro	01 nero 9005 black 9005 negro 9005	02 bianco white blanco	03 bianco 1013 white 1013 blanco 1013	04 bianco 9010 white 9010 blanco 9010	05 verde green verde	06 verde 6005 green 6005 verde 6005	07 marrone brown marrone	08 marrone 8017 brown 8017 marrone 8017	09 giallo 1006 yellow 1006 amarillo 1006	10 grigio 7001 grey 7001 gris 7001	13 rosso 3003 red 3003 rojo 3003	14 argento silver plateado	15 bronzo bronze bronce
-----------------------------------	---	---------------------------------	--	--	-------------------------------	--	-----------------------------------	--	---	---	---	-------------------------------------	----------------------------------

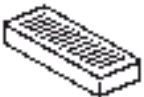
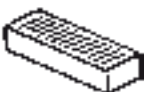
Art. 699990190.0	01	DESCRIZIONE DESCRIPTION DESCRIPCIÓN	APPLICAZIONE APPLICATION APLICACIÓN	MATERIALE MATERIAL MATERIAL	SCATOLA BOX CAJA
		 <p>Tappo 40x80 Plug 40x80 Tapón 40x80</p>		PS	
		 <p>Tappo 50x50 Plug 50x50 Tapón 50x50</p>		PS	
		 <p>Spessore zigrinato per vetrocamera 10x2 Knurled shim for double glazing 10x2 Espesor rayado para sobrevidriera 10x2</p>		PP	20 Kg
		 <p>Spessore zigrinato per vetrocamera 10x3 Knurled shim for double glazing 10x3 Espesor rayado para sobrevidriera 10x3</p>		PP	20 Kg
		 <p>Spessore zigrinato per vetrocamera 10x4 Knurled shim for double glazing 10x4 Espesor rayado para sobrevidriera 10x4</p>		PP	20 Kg
		 <p>Spessore zigrinato per vetrocamera 10x5 Knurled shim for double glazing 10x5 Espesor rayado para sobrevidriera 10x5</p>		PP	20 Kg

16  
 elettro col. nero  
 electrum col. black  
 anodizado col. negro

25  
 marrone 8014  
 brown 8014  
 marrone 8014

26  
 verde 5293  
 gothic 5293  
 verde 5293

37  
 ottone  
 brass  
 ottone

39  
 nero opaco  
 opaque black  
 negro opaco

60  
 verde 5123  
 green 5123  
 verde 5123





68  
 grigio 9006  
 gothic 9006  
 gris 9006

77  
 cromo  
 chrome  
 cromo

MO  
 mogano  
 mahogany  
 caoba

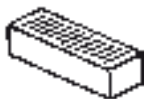
NO  
 noce  
 walnut  
 nogal

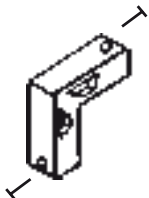
RO  
 rovere  
 oak  
 roble

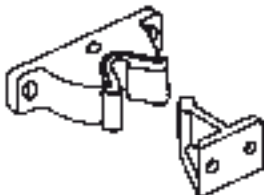
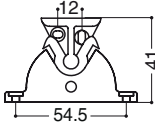
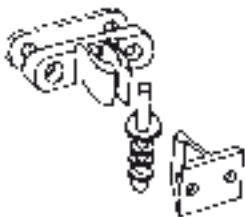
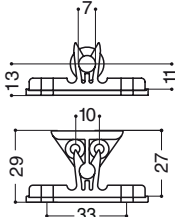
DESCRIZIONE DESCRIPTION DESCRIPCIÓN	APPLICAZIONE APPLICATION APLICACIÓN	MATERIALE MATERIAL MATERIAL	SCATOLA BOX CAJA
<p><b>Art. 699991689.0</b> 10</p>  <p>Spessore zigrinato per vetrocamera 10x7                      Knurled shim for double glazing 10x7                      Espesor rayado para sobrevidriera 10x7</p>		PP	20 Kg
<p><b>Art. 699990950.0</b> 01</p>  <p>Squadretta telaio di scorrimento per zanzariera scorrevole e saliscendi                      Frame corner joint for insect roller screen with up and down track system                      Escuadra marco de ventana para mosquitera corredera y alzable</p>		PA	100 Pz.
<p><b>Art. 699991996.0</b> 01</p>  <p>Squadretta telaio di scorrimento per zanzariera scorrevole e saliscendi con viti inserite                      Frame corner joint for insect roller screen with up and down track system with inserted screws                      Escuadra marco de ventana para mosquitera corredera y alzable con tornillos inseridos</p>		PA	100 Pz.
<p><b>Art. 699990954.0</b> 01</p>  <p>Tassello compensatore per zanzariera scorrevole e saliscendi                      Compensator insert for insect roller screen with up and down track system                      Retenedor compensador para mosquiterera corredera y alzable</p>		PA	
<p><b>Art. 699992605.0</b> 01</p>   <p>Pinza fermaporta grande                      Large door stop pliers                      Pinza retenedor grande</p>		PA	
<p><b>Art. 699992604.0</b> 01</p>   <p>Pinza fermaporta piccolo                      Small door stop pliers                      Pinza retenedor pequeña</p>		PA	



00  
neutro  
neutral  
neutro

01  
nero 9005  
black 9005  
negro 9005

02  
bianco  
white  
blanco

03  
bianco 1013  
white 1013  
blanco 1013

04  
bianco 9010  
white 9010  
blanco 9010

05  
verde  
green  
verde

06  
verde 6005  
green 6005  
verde 6005

07  
marrone  
brown  
marrone

08  
marrone 8017  
brown 8017  
marrone 8017

09  
giallo 1006  
yellow 1006  
amarillo 1006

10  
grigio 7001  
grey 7001  
gris 7001

13  
rosso 3003  
red 3003  
rojo 3003

14  
argento  
silver  
plateado

15  
bronzo  
bronze  
bronce

Art. 699990150.0 01



DESCRIZIONE DESCRIPTION DESCRIPCIÓN	APPLICAZIONE APPLICATION APLICACIÓN	MATERIALE MATERIAL MATERIAL	SCATOLA BOX CAJA
Cappello da prete o battuta di riscontro Striker ledge Tope persiana mallorquina marco abierto			

Art. 699990967.0 00



Cilindro parapolvere Ø 6 Dust cover cylinder Ø 6 Encuentro de suelo antipolvo Ø 6		OTT	
--	--	-----	--

Art. 699990968.0 00



Cilindro parapolvere Ø 8 Dust cover cylinder Ø 8 Encuentro de suelo antipolvo Ø 8		OTT	
--	--	-----	--

Art. 699990969.0 00



Cilindro parapolvere Ø 10 Dust cover cylinder Ø 10 Encuentro de suelo antipolvo Ø 10		OTT	
---	--	-----	--

Art. 699991754.0 00





Cilindro parapolvere Ø 12 Dust cover cylinder Ø 12 Encuentro de suelo antipolvo Ø 12		OTT	
---	--	-----	--

Art. 699990349.0 00



Forbici in metallo LÖWE LÖWE metal scissors Tijeras de metal LÖWE		ACC	
---	--	-----	--

- 16** eletto col. nero  
electrum col. black  
anodizado col. negro
- 25** marrone 8014  
brown 8014  
marrone 8014
- 26** verde 5293  
gothic 5293  
verde 5293
- 37** ottone  
brass  
ottone
- 39** nero opaco  
opaque black  
negro opaco
- 60** verde 5123  
green 5123  
verde 5123
- 68** grigio 9006  
gothic 9006  
gris 9006
- 77** cromo  
chrome  
cromo
- MO** mogano  
mahogany  
caoba
- NO** noce  
walnut  
nogal
- RO** rovere  
oak  
roble

	DESCRIZIONE DESCRIPTION DESCRIPCIÓN	APPLICAZIONE APPLICATION APLICACIÓN	MATERIALE MATERIAL MATERIAL	SCATOLA BOX CAJA
<b>Art. 69992156.0</b> 00 <input type="text"/> <input type="text"/> <input type="text"/> <input type="text"/> <input type="text"/> <input type="text"/> <input type="text"/> <input type="text"/> <input type="text"/> <input type="text"/> <input type="text"/> <input type="text"/> <input type="text"/> <input type="text"/> <input type="text"/> <input type="text"/> <input type="text"/> <input type="text"/> <input type="text"/> <input type="text"/> <input type="text"/> 	Lama LÖWE LÖWE blade Hoja LÖWE		ACC	
<b>Art. 69992186.0</b> 00 <input type="text"/> <input type="text"/> <input type="text"/> <input type="text"/> <input type="text"/> <input type="text"/> <input type="text"/> <input type="text"/> <input type="text"/> <input type="text"/> <input type="text"/> <input type="text"/> <input type="text"/> <input type="text"/> <input type="text"/> <input type="text"/> <input type="text"/> <input type="text"/> <input type="text"/> <input type="text"/> <input type="text"/> 	Basamento per forbice LÖWE LÖWE scissors base plate Base para tijeras LOWE		ACC	
<b>Art.</b> <input type="text"/> <input type="text"/> <input type="text"/> <input type="text"/> <input type="text"/> <input type="text"/> <input type="text"/> <input type="text"/> <input type="text"/> <input type="text"/> <input type="text"/> <input type="text"/> <input type="text"/> <input type="text"/> <input type="text"/> <input type="text"/> <input type="text"/> <input type="text"/> <input type="text"/> <input type="text"/> <input type="text"/>				
<b>Art.</b> <input type="text"/> <input type="text"/> <input type="text"/> <input type="text"/> <input type="text"/> <input type="text"/> <input type="text"/> <input type="text"/> <input type="text"/> <input type="text"/> <input type="text"/> <input type="text"/> <input type="text"/> <input type="text"/> <input type="text"/> <input type="text"/> <input type="text"/> <input type="text"/> <input type="text"/> <input type="text"/> <input type="text"/>				
<b>Art.</b> <input type="text"/> <input type="text"/> <input type="text"/> <input type="text"/> <input type="text"/> <input type="text"/> <input type="text"/> <input type="text"/> <input type="text"/> <input type="text"/> <input type="text"/> <input type="text"/> <input type="text"/> <input type="text"/> <input type="text"/> <input type="text"/> <input type="text"/> <input type="text"/> <input type="text"/> <input type="text"/> <input type="text"/>				
<b>Art.</b> <input type="text"/> <input type="text"/> <input type="text"/> <input type="text"/> <input type="text"/> <input type="text"/> <input type="text"/> <input type="text"/> <input type="text"/> <input type="text"/> <input type="text"/> <input type="text"/> <input type="text"/> <input type="text"/> <input type="text"/> <input type="text"/> <input type="text"/> <input type="text"/> <input type="text"/> <input type="text"/> <input type="text"/>				





**SEDE - HEAD OFFICE - SEDE**

Via S. Ubaldo 31/D - 60030 Monsano (AN) - Tel +39 0731 61582 r.a. - Fax +39 0731 615830-40

**COME RAGGIUNGERCI**

- **Dalla autostrada A14 BOLOGNA-TARANTO:** uscire al casello ANCONA NORD ed immettersi nella SS76 direzione ROMA proseguire fino all'uscita n 19 per MONSANO e da qui raggiungere la ZONA INDUSTRIALE di MONSANO
- **Dalla SS76 ROMA direzione ANCONA** l'uscita è la nr. 19 per MONSANO, proseguire per la ZONA INDUSTRIALE di MONSANO  
*Altre vie di collegamento sono l'aeroporto "Raffaello Sanzio" di FALCONARA (Ancona), il porto di Ancona e la linea ferroviaria ANCONA-ROMA*

**DIRECTIONS**

- **From the A14 BOLOGNA-TARANTO motorway:** exit at ANCONA NORD and take the SS76 direction ROMA. Continue until junction 19 for MONSANO and from here go towards MONSANO's INDUSTRIAL ESTATE.
- **From the SS ROMA towards ANCONA** Junction 19 for MONSANO continue to MONSANO's INDUSTRIAL ESTATE.  
*Other ways of reaching our main office are Ancona's Raffaello Sanzio airport in FALCONARA, the port of Ancona and the railway line ANCONA - ROMA.*

**COMO LLEGAR**

- **Desde la autopista A14 BOLOGNA-TARANTO:** Salir a la casilla de peaje de ANCONA NORD y tomar la autovía estatal SS76 dirección ROMA. Proseguir hasta la salida (uscita) N. 19 para MONSANO y desde aquí alcanzar la ZONA INDUSTRIAL de MONSANO
- **Desde la autovía estatal SS76 ROMA dirección ANCONA** La salida es la N. 19 para MONSANO, proseguir hasta la ZONA INDUSTRIAL de MONSANO.  
*Otras formas de llegar son: el aeropuerto de FALCONARA (Ancona), el puerto de Ancona y la línea ferroviaria ANCONA- ROMA.*

FINITO DI STAMPARE NEL MESE DI APRILE 2009  
PRINTED ON APRIL 2009  
TERMINADO DE IMPRIMIR EN EL MES DE AVRIL 2009

**CATALOGO OMAGGIO PER CLIENTI ESENTE DA BOLLA ART. 4 D.P.R. 627/78**  
FREE CATALOGUE FOR CUSTOMERS EXCEPT OF DELIVERY NOTE ART. 4 D.P.R. 627/78  
CATALOGO EN REGALO PARA LOS CLIENTES LIBRE DE DOCUMENTO DE TRANSPORTE SEGÚN ART. 4 D.P.R. 627/78